

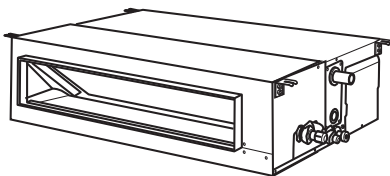

Service Manual

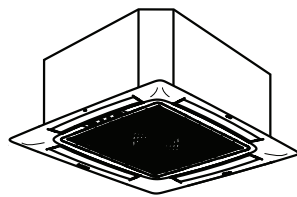
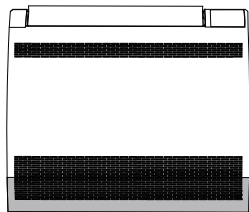
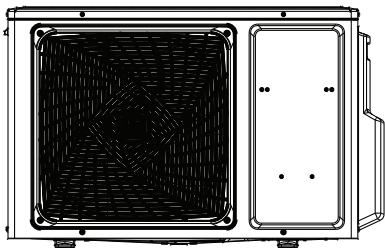

Arctic VHE Outdoor

- 1U09EH2VHE
- 1U12EH2VHE
- 1U18EH2VHE
- ASH109URDSE
- ASH112URDSE
- ASH118URDSE

Indoor

Wall Mount - Highwall

- AW09EH2VHD
- AW12EH2VHD
- AW18EH2VHD
- ASYW09URDWD
- ASYW12URDWD
- ASYW18URDWD

Cassette

- AB09SC2VHA
- AB12SC2VHA
- AB18SC2VHA

Console

- USYF09UCDWA
- USYF12UCDWA
- USYF18UCDWA

Ducted

- USYM09UCDSA
- USYM12UCDSA
- USYM18UCDSA

Arctic VHD Outdoor

- 1U09EH2VHD
- 1U12EH2VHD
- 1U18EH2VHD
- ASH109URDSD
- ASH112URDSD
- ASH118URDSD

Indoor

Wall Mount - Highwall

- AW09EH2VHD
- AW12EH2VHD
- AW18EH2VHD
- ASYW09URDWD
- ASYW12URDWD
- ASYW18URDWD

Design may vary by model number.

- Please read this manual before installing this product.
- Keep this service manual for future reference.

Table of Contents

Safety Precautions/Introduction.....	3
System Specifications	7
Outdoor Unit Controls and Components	10
Indoor Unit Controls and Components	20
Compact Cassette Technical Overview.....	28
Mid-Static Ducted Technical Overview.....	38
Console Technical Overview.....	52
Sequence of Operation	62
Error Codes and Troubleshooting.....	75
Reference Information	104

[This page intentionally left blank.]

Table of Contents

Safety Precautions 4
 Warnings and Cautions 4
Introduction to System 5
 Specifications for proper operation should be followed..... 5
 System Fundamentals..... 5

Safety Precautions

- Read these Safety Precautions carefully to ensure correct installation.
- This manual classifies the precautions into WARNING and CAUTION.
- Be sure to follow all the precautions below: they are all important for ensuring safe operation.
- ⚠ **WARNING:** Failure to follow any WARNING could result in serious injury or death.
- ⚠ **CAUTION:** Failure to follow any CAUTION may in some cases result in grave consequences.
- The following safety symbols are used throughout this manual:



Be sure to observe this instruction



Be sure to establish a ground connection



Never attempt

- After completing installation, test the unit to check for installation errors. Give the user adequate instructions concerning the use and cleaning of the unit according to the Operation Manual.

⚠ WARNING

Improper installation may cause water leakage, electrical shock, or fire.

- Install the heat pump according to the instructions given in this manual.

Incomplete installation may cause water leakage, electrical shock, or fire.

- Be sure to use the supplied or specified installation parts.

Use of other parts may cause the unit to come loose, water leakage, electrical shock, or fire

- Install the heat pump on a solid base that can support the unit's weight.

An inadequate base or incomplete installation may cause injury in the event the unit falls off the base.

- Electrical work should be carried out in accordance with the installation manual and national, state, or local code.

Insufficient capacity or incomplete electrical work may cause electrical shock or fire.

- Be sure to use a dedicated power circuit. Never use a power supply shared by another appliance.

- For wiring, use a cable long enough to cover the entire distance with no splicing.

- Use the specified types of wires for electrical connections between the indoor and outdoor units.

Firmly clamp the interconnecting wires to avoid stress or sharp edges. Incomplete connections or clamping may cause terminal overheating or fire.

- After connecting the wiring, be sure to route the cables so that they do not put undue force on the electrical covers or panels.

Install covers over the wires. Incomplete cover installation may cause terminal overheating, electrical shock, or fire.

- If any refrigerant has leaked out during the installation work, ventilate the room.

(The refrigerant produces a toxic gas if exposed to flames.)

- After all installation is complete, check to make sure that no refrigerant is leaking out.

(The refrigerant produces a toxic gas if exposed to flames.)

- When installing or relocating the system, be sure to keep the refrigerant circuit free from substances other than the specified refrigerant (R410A), such as air or moisture.

(Any presence of air or other foreign substance in the refrigerant circuit causes an abnormal pressure rise or rupture, resulting in injury.)

- Be sure to establish a ground. Do not ground the unit to a utility pipe, arrester, or telephone earth.

Inadequate grounding may cause electrical shock, or fire. A high surge current from lightning or other sources may cause damage.



⚠ CAUTION

- Do not install this system in a place where there is danger of exposure to inflammable gas leakage. If the gas leaks and builds up around the unit, it may catch fire.



- Install drain piping according to the instructions of this manual.

Inadequate piping may cause flooding.

- Tighten the flare nuts with a torque wrench.

If the flare nut is tightened too hard, the flare nut may crack after a long time and cause refrigerant leakage.

- Maintain proper clearances around unit per this manual.

Introduction to System

Single Zone Ductless Split System Heat Pumps feature a wall mounted indoor fan/evaporator unit that receives refrigerant from an inverter driven variable speed outdoor condensing unit. The system operation is controlled with a remote control.

The outdoor unit features a variable speed rotary compressor, EEV metering device and DC fan motor. These systems use R410A refrigerant and PVE oil. The outdoor units are 208/230 volt rated systems. They come factory charged for up to 25 ft. of interconnecting piping.

The indoor units are wall mounted. They feature a DC blower motor and a DC louver motor. The unit has a room temperature sensor and an evaporator tube temperature sensor. The wall unit is powered by voltage from the outdoor unit.

Specifications for Proper Operation

- The systems are designed to operate in temperature. The indoor unit can be set from 60°F-86°F (16°C-30°C) during both cooling and heating.
- PVE oil is non-reactive to water and will not go into hydrolysis. There is no need to add a refrigeration drier when servicing or installing this system.
- The indoor wall mounted unit receives operating voltage and communication data signals on #14 AWG wire that connects between the indoor and outdoor units. There should not be any splices in the field wiring that goes between terminals 1, 2, 3 and 4. A splice in these wires may cause the system to lose communication between the indoor and outdoor units. The system will then display an error code E7.
- The field-supplied refrigerant tubing connects using flare type fittings at both the indoor and outdoor units. Tubing must be sized per the specifications. Both lines must be insulated. The only method of checking charge or adjusting charge is by weight method explained in this manual (no exceptions).
- The condensate system is a gravity type. A field installed condensate pump may be added to the system. Always follow the manufacturer's installation instructions when installing a condensate pump.
- Proper clearances at both indoor and outdoor units must be maintained. Improper clearances cause incorrect refrigerant pressures and coil freezing.

System Fundamentals

The indoor unit will sense room temperature at the point where the wall unit is installed. The indoor fan will run continuously when placed in heating or cooling mode and will not cycle on and off with the outdoor unit. If it did, room temperature could not be sensed or maintained.

The inverter compressor system in the outdoor unit will vary the refrigerant flow and indoor air volume levels to match the comfort requirement inside the conditioned space. If an abnormal condition is detected by the system's sensors, the system has the ability to take reactive measures.

The amount of refrigerant flow and associated capacity generated by the system will be determined by how fast the system's variable speed rotary compressor is pumping. The compressor operating speed is determined by the difference between the conditioned space temperature and the set point.

If a large amount of capacity is needed, the compressor will operate at a high speed. As the need for capacity reduces and the temperature of the room nears set point, the compressor will slow down. When set point has been reached, the compressor will shut off while the fan continues to operate. When a difference in temperature is sensed between the set point and room, the compressor will restart at a new calculated speed.

If a system sensor determines there is a need to adjust the frequency signal to prevent a system malfunction, the compressor frequency may be over ridden and a new frequency established. It should be noted that the frequency signal level that is sent to the compressor cannot be determined by a servicing technician.

In this manual, system components, operation, sensor functions, and diagnostic procedures will be explained in greater detail.

System Specifications

Model Name	Outdoor	1U09EH2VHE/ASH109URDSE	1U12EH2VHE/ASH112URDSE	1U18EH2VHE/ASH118URDSE
	Indoor	AW09EH2VHD/ASYW09URDWD	AW12EH2VHD/ASYW12URDWD	AW18EH2VHD/ASYW18URDWD
Cooling	Rated Capacity <i>Btu/hr</i>	9,000	12,000	18,000
	Capacity Range <i>Btu/hr</i>	3100~12000	3100~15000	8,500~21000
	Rated Power Input <i>W</i>	560	800	1,385
	SEER	30	27	23
	EER	16.0	15.0	13.0
	Moisture Removal <i>Pt./h</i>	0.60	1.60	3.80
Heating	Rated Heating Capacity 47°F <i>Btu/hr</i>	10,000	14,500	20,000
	Heating Capacity Range <i>Btu/hr</i>	3100~20000	3100~22000	8700~27000
	Rated Power Input <i>W</i>	845	1,400	1,920
	HSPF	15.2	13.0	12.0
	Max. Heating Capacity 5°F <i>Btu/hr</i>	12,000	17,000	25,000
	Max. Heating Capacity -4°F <i>Btu/hr</i>	10,500	15,500	22,000
	Max. Heating Capacity -15°F <i>Btu/hr</i>	8,600	14,500	20,000
	Max. Heating Capacity -22°F <i>Btu/hr</i>	7,400	12,400	17,200
Max. Heating Capacity -31°F <i>Btu/hr</i>	3,200	5,400	7,400	
Operating Range	Cooling °F(°C)	14~115(-10~46)	14~115(-10~46)	14~115(-10~46)
	Heating °F(°C)	-31~75(-35~24)	-31~75(-35~24)	-31~75(-35~24)
Power Supply	Voltage, Cycle, Phase <i>V/Hz/-</i>	208-230/60/1	208-230/60/1	208-230/60/1
Outdoor Unit	Compressor Type	DC Inverter Rotary	DC Inverter Rotary	DC Inverter Rotary
	Maximum Fuse Size <i>A</i>	15	20	30
	Minimum Circuit Amp <i>A</i>	13	14	20
	Outdoor Noise Level <i>dB</i>	55	55	51
	Dimension: Height <i>in (mm)</i>	27 1/2(697)	27 1/2(697)	30(762)
	Dimension: Width <i>in (mm)</i>	35(890)	35(890)	36 1/4(920)
	Dimension: Depth <i>in (mm)</i>	13 7/8(353)	13 7/8(353)	15 1/8(385)
	Weight (Ship/Net)- <i>lbs (kg)</i>	119.7/102.198.3 (54.3/46.3)	124.6/108 (56.5/49)	152.6/132.7 (69.2/60.2)
Refrigerant Line	Connections	Flare	Flare	Flare
	Liquid O.D. <i>in</i>	1/4	1/4	1/4
	Suction O.D. <i>in</i>	1/2	1/2	1/2
	Factory Charge <i>Oz</i>	57.0	62.1	82.9
	Maximum Line Length <i>Ft / m</i>	50/15	50/15	83/25
	Maximum Height <i>Ft / m</i>	33/10	33/10	50/15

Specifications

Highwall Indoor



	AW09EH2VHD	AW12EH2VHD	AW18EH2VHD
Rated Cooling Capacity Btu/hr	9,000	12,000	18,000
Rated Heating Capacity Btu/hr	10,000	14,500	20,000
Voltage, Cycle, Phase V/Hz/-	208-230/60/1	208-230/60/1	208-230/60/1
Indoor Sound dB (Turbo/H/M/L/Quiet)	48/38/35/32/28	48/46/39/32/30	49/46/41/36/32
Airflow CFM (Turbo/High/Med/Low/Quiet)	583/383/324/264/240	597/524/430/344/324	636/541/436/330/259
Dimension: H x W x D in (mm)	12 7/8 x 39 3/4 x 8 7/8 (327 x 1009 x 223)	12 7/8 x 39 3/4 x 8 7/8 (327 x 1009 x 223)	13 1/4 x 44 3/8 x 9 1/16 (337 x 1126 x 230)
Weight (Ship/Net)- lbs (kg)	36.4/28.7 (16.5/13)	36.4/28.7 (16.5/13)	44.1/37.5 (20/17)
Liquid / Suction O.D. in	1/4 1/2	1/4 1/2	1/4 1/2

Cassette Indoor



	AB09SC2VH(-)	AB12SC2VH(-)	AB18SC2VH(-)
Rated Cooling Capacity Btu/hr	9,000	12,000	18,000
Rated Heating Capacity Btu/hr	10,000	13,000	19,000
Voltage, Cycle, Phase V/Hz/-	208-230/60/1	208-230/60/1	208-230/60/1
Airflow CFM (Turbo/H/M/L/Quiet)	410/365/305/265/205	410/365/305/265/205	470/410/365/295/252
Indoor Sound dB (Turbo/H/M/L/Quiet)	42/40/36/32/25	42/40/36/32/25	45/42/40/36/32
Grille Model	PB-700KB	PB-700KB	PB-700KB
Chassis Dimension: HxWxD in (mm)	10 1/4 x 22 7/16 x 2 3/8 (260 x 570 x 570)	10 1/4 x 22 7/16 x 2 3/8 (260 x 570 x 570)	10 1/4 x 22 7/16 x 2 3/8 (260 x 570 x 570)
Grille Dimension: HxWxD in (mm)	2 3/8 x 27 9/16 x 27 9/16 (60 x 700 x 700)	2 3/8 x 27 9/16 x 27 9/16 (60 x 700 x 700)	2 3/8 x 27 9/16 x 27 9/16 (60 x 700 x 700)
Weight (Ship/Net)- lbs (kg)	46.3/37.5 (21/17)	46.3/37.5 (21/17)	46.3/37.5 (21/17)
Liquid / Suction O.D. in	1/4 3/8	1/4 3/8	1/4 1/2
Drainpipe Size O.D. in	1 1/4	1 1/4	1 1/4
Condensate Pump	Standard	Standard	Standard
Max. Drain-Lift height in(mm)	27 9/16 (700)	27 9/16 (700)	27 9/16 (700)

Specifications

Console Indoor

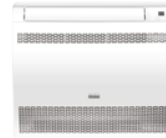
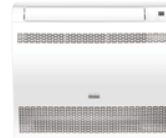
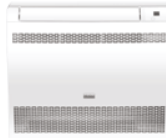

	USYF09UCDWA	USYF12UCDWA	USYF18UCDWA
Rated Cooling Capacity Btu/hr	9,000	12,000	15,000
Rated Heating Capacity Btu/hr	10,000	13,000	18,000
Voltage, Cycle, Phase V/Hz/°	208-230/60/1	208-230/60/1	208-230/60/1
Airflow (Turbo/High/Med/Low/Quiet) CFM	264/235/205/176/147	294/264/205/176/147	341/311/282/252/223
Indoor Sound Level dB (Turbo/High/Med/Low/Quiet)	40/32/25/20	42/34/26/21	46/37/33/28
Chassis Dimension: HxWxD in (mm)	23.6/27.5/8.3 (600/700/210)		
Weight (Ship/Net)- lbs (kg)	36/40 (16.5/18.5)		
Liquid / Suction O.D. in	1/4 3/8	1/4 3/8	1/4 1/2
Drainpipe Size O.D. in	1 1/4	1 1/4	1 1/4

Mid-Static Ducted Indoor



	USYM09UCDSA	USYM12UCDSA	USYM18UCDSA
Rated Cooling Capacity Btu/hr	9,000	12,000	18,000
Rated Heating Capacity Btu/hr	10,000	13,000	19,000
Voltage, Cycle, Phase V/Hz/-	208-230/60/1	208-230/60/1	208-230/60/1
Airflow (Turbo/High/Med/Low/Quiet) CFM	494/423/352/264	494/423/352/264	635/529/458/388
Max. External Static Pressure in.W.G (Pa)	0.6 (150)	0.6 (150)	0.6 (150)
Indoor Sound Level dB (Turbo/High/Med/Low/Quiet)	35/32/29/26	35/32/29/26	37/34/32/29
Chassis Dimension: HxWxD in (mm)	27.5/27.5/9.7(700/700/248)	27.5/27.5/9.7(700/700/248)	43.3/27.5/9.7(1100/700/248)
Weight (Ship/Net)- lbs (kg)	57/66(26/30)	57/66(26/30)	70/77 (32/35)
Liquid / Suction O.D. in	1/4 3/8	1/4 3/8	1/4 1/2
Drainpipe Size O.D. in	1 1/4	1 1/4	1 1/4
Condensate Pump	Standard	Standard	Standard
Max. Drain-Lift height in(mm)	39(1000)	39(1000)	39(1000)

Table of Contents

Outdoor Unit Introduction	11
Outdoor Component Identification	11
Outdoor Main Control Board	12
Terminal Block.....	13
Reactor	13
Compressor	13
Outdoor Fan Motor	13
Discharge Temperature Sensor	14
Defrost Temperature Sensor	14
Outdoor Ambient Temperature Sensor	14
Suction Line Temperature Sensor.....	14
4-Way Valve	15
Electronic Expansion Valve.....	15
Accumulator	15
Strainers	15
Base Pan Heater.....	15

Outdoor Unit Introduction

The outdoor unit has two circuit boards, an Inverter Power Module (IPM) that drives the compressor and main control board (PCB) that manages system functions and inverter calculations. Sensors monitor key temperatures throughout the system to manage operational decisions.

Outdoor Component Identification

- 1 4-Way Valve
- 2 Accumulator
- 3 Compressor
- 4 Defrost Temperature Sensor
- 5 Discharge Temperature Sensor
- 6 Electronic Expansion Valve
- 7 Refrigerant Strainers
- 8 Ambient Temperature Sensor
- 9 Fan Motor
- 10 Power Factor Reactor
- 11 Suction Line Temperature Sensor
- 12 Terminal Block
- 13 Main Control Board (PCB)
- 14 Module Control Board (IPM)
- 15 Fan Blade

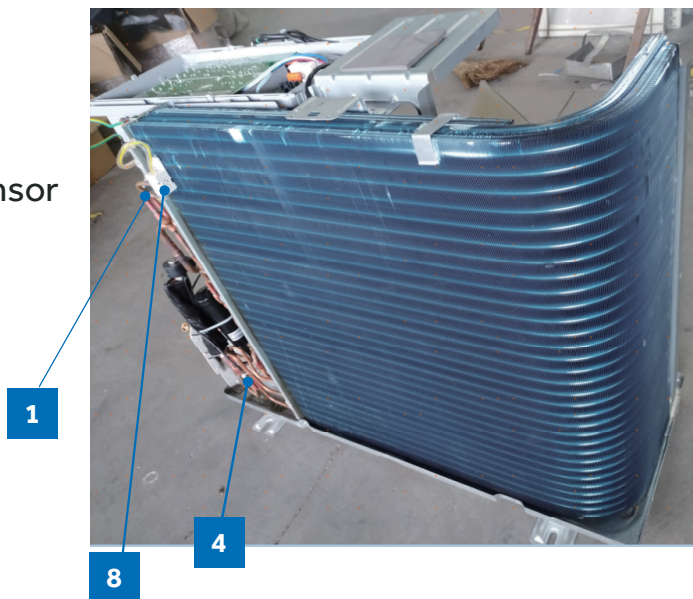
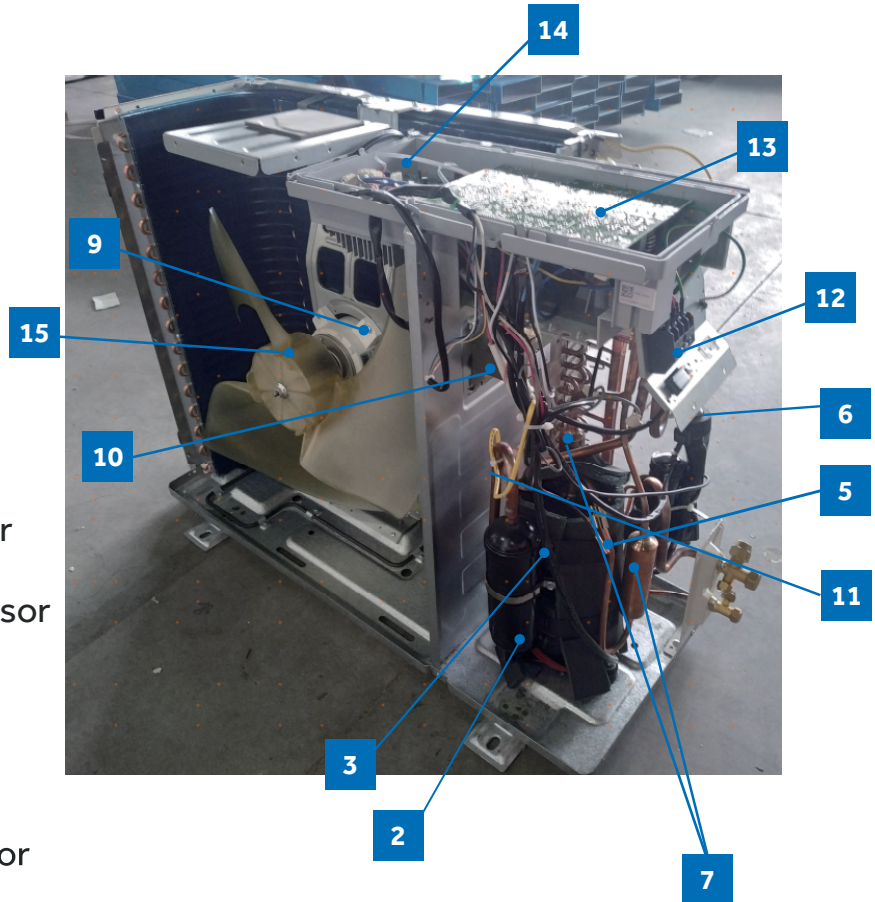

PCB

PCB (1) (Outdoor Control PCB)

- 1 CN1 and CN2 - 230 VAC power from terminal block connections 1(N) and 2(L), CN6-connector for COM-N
- 2 CN5 - Connector for GND
- 3 CN4-Communication connection between the indoor board and the outdoor board
- 4 CN8 and CN9 - 230 VAC power to the IPM connections CN8 (or CN1) and CN9(or CN2)
- 5 CN21 - Connector for fan motor
- 6 CN10 - Connector for four way valve coil
- 7 CN18,CN20,CN31 - connections for temperature sensors
- 8 CN26, CN24 - 310 VDC power from the IPM connections CN1 (or CN8) and CN5 (or CN9)
- 9 CN22-Connector for DC POWER 15V and 5V to the IPM
- 10 CN23 -5VDC and 15VDC pulsing communication connection between the PCB and the IPM
- 11 CN16-Connector for the electronic expansion valve
- 12 CN48 -Connector for the base pan heater
- 13 CN49-Connector for COMP heater
- 14 CN38- Connector for diagnostic port
- 15 RV1, RV2, RV3 Varistor

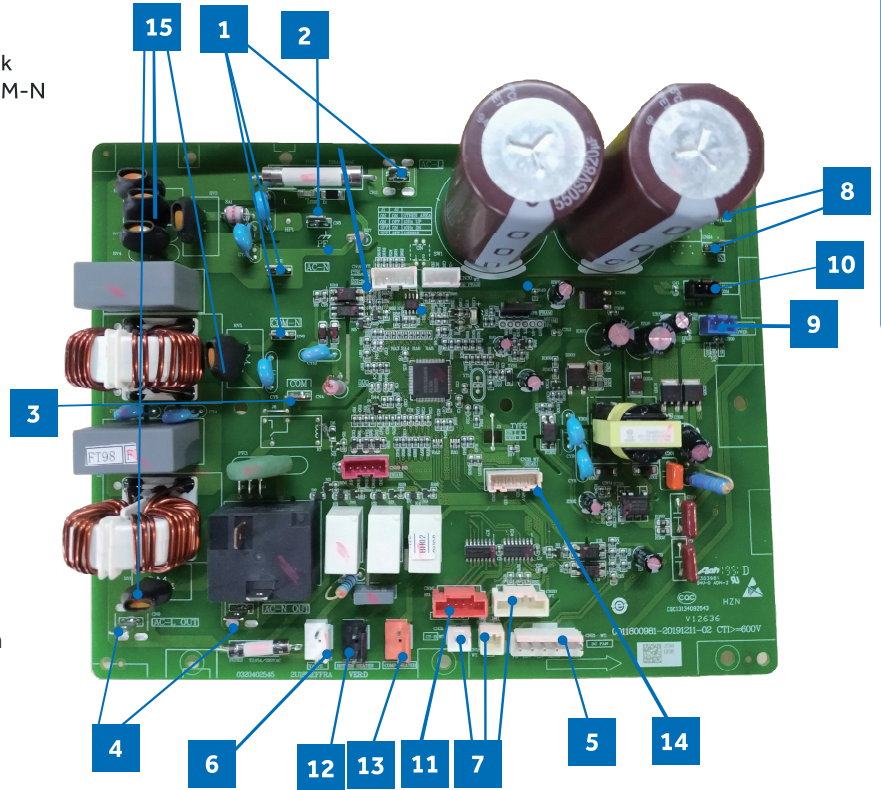

PCB (2) (IPM for 09K)

- 16 CN10 - Connector for the DC power 5V and 15V form the control PCB
- 17 CN11-Pulsing communication connection between the IPM and the PCB
- 18 CN1,CN5-310 VDC signal to the PCB connections CN26 and CN24
- 19 LI(CN7),LO(CN6)-Connector for reactor
- 20 CN8, CN9 - 230 VAC signal from the PCB
- 21 CN2, CN3, CN4- Compressor U, V, and W connections

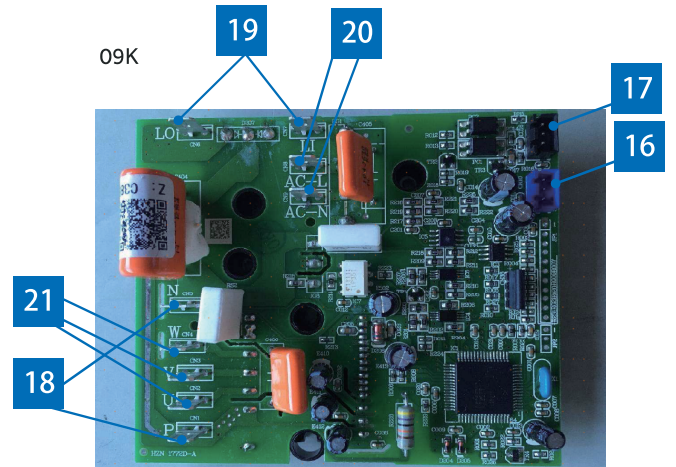

PCB (3) (IPM for 12-18K)

- 22 CN10-5 VDC and 15 VDC power signal from PCB connection CN22
- 23 CN11 - Connector for communicate between the control board and the module board
- 24 CN8, CN9 - 310 VDC power to PCB connections CN26 and CN24
- 25 LI (CN3), LO (CN4) - Connector for reactor
- 26 CN1, CN2 - 230 VAC power from PCB connections CN8 and CN9
- 27 CN5, CN6, CN7-Compressor U, V, and W connections

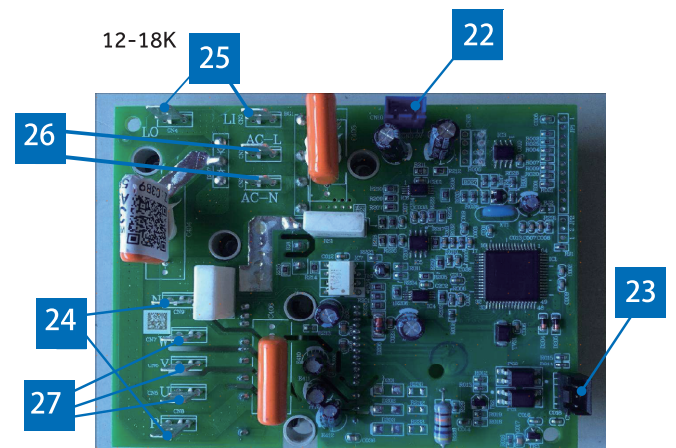

Terminal Block



The outdoor unit is powered by 208/230 volt single phase electricity connected at the terminal block.

Terminals 1 and 2 connect this voltage to the system. The number 3 terminal is communication that connects wiring between the indoor and outdoor units. A ground terminal connects the outdoor unit to the line voltage power source.

Condensate safety switches should break the wire on terminal 2.

The indoor unit is also powered by the same electrical supply as the outdoor unit. #14 stranded copper wire is connected to the wiring terminal block at the outdoor unit and is run to the same terminals on the indoor terminal block.

When installing the field supplied wiring, make certain the wire gauge is correct. There should not be any electrical wiring splices between the indoor unit and outdoor unit wire connection 3. This wire is used to carry communication data between the indoor and outdoor units. A wiring splice where wires are twisted in a wire nut may cause deformation of the communication signal. If communication is lost between the indoor and outdoor units, an ERROR CODE E7 will occur. (See Page 36.)

Power Factor Reactor



The Reactor is a power filter. It is unlikely to ever have an electrical failure of this component.

The Reactor of 09K is electrically connected to the IPM on terminal connections CN6 and CN7.

The Reactor of 12K&18K is electrically connected to the IPM on terminal connections CN3 and CN4.

Compressor



The compressor is a three phase DC inverter driven rotary type, capable of variable speed operation. The compressor operating frequency will be determined by the temperature difference between set point and room temperature.

The compressor of 09K is electrically connected to the IPM on terminal connections CN2, CN3 and CN4.

The compressor of 12K&18K is electrically connected to the IPM on terminal connections CN5, CN6 and CN7.

Protection of the compressor will be provided by the discharge temperature sensor, the suction line temperature sensor, and the overcurrent protection parameter in the PCB.

Fan Motor



The fan motor is a variable speed motor. The required speed is calculated by the PCB. The motor is electrically connected to the PCB via PLUG CN-21.

In COOL MODE, the motor will slow down as outdoor air temperature falls. In HEAT MODE, the motor will increase speed as the outdoor air temperature falls.

Discharge Temperature Sensor



The Discharge Temperature Sensor is a negative coefficient thermistor that senses the temperature of the compressor hot gas. The PCB monitors the temperature of the compressor hot gas and will make inverter speed changes in response to input from this device.

This sensor connects to the Main Control Board at PLUG CN-20.

Defrost Temperature Sensor A



The Defrost Temperature Sensor A is a negative coefficient thermistor that will change resistance in response to outdoor coil temperature changes. The PCB monitors the temperature of the outdoor coil to determine when the system should perform a defrost cycle. The sensor also monitors coil temperature during defrost cycles to determine termination conditions.

This sensor connects to the Main Control Board at PLUG CN-20.

Ambient Temperature Sensor



The Ambient Temperature Sensor is a negative coefficient thermistor that will change resistance in response to outdoor air temperature changes. The PCB monitors the temperature of the outdoor air to determine fan speed requirements and inverter speed. The sensor also plays a role in calculation of required defrost conditions.

This sensor connects to the Main Control Board at PLUG CN-20.

Suction Line Temperature Sensor

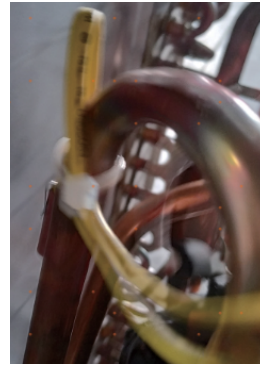

The Suction Line Temperature Sensor is a negative coefficient thermistor that senses the temperature of the suction line. The PCB monitors the temperature of the suction line and the EEV operation to maintain an acceptable superheat.

This sensor connects to the Main Control Board at PLUG CN-18.

Defrost Temperature Sensor B



The Defrost Temperature Sensor B is same as the Defrost Temperature Sensor A. The system chooses the lowest of the two temperature values.

This sensor connects to the Main Control Board at PLUG CN-31.

4-Way Valve



The 4-Way Valve redirects the flow of refrigerant in the piping circuit to allow the system to reverse the functions of the indoor and outdoor coils. When de-energized in COOL MODE, the valve will direct the refrigerant hot gas to the outdoor coil. When energized in HEAT MODE, the valve will direct the hot gas to the indoor coil.

The valve flow direction capability is controlled by an electrical solenoid. When energized with 230 VAC, the solenoid will magnetically move an internal slide within the 4-Way Valve to change the direction of refrigerant flow.

The 4-Way Valve is electrically connected to the Main Control Board at PLUG CN-10.

Electronic Expansion Valve



The metering device is an electronic expansion valve. The valve consists of an electrical operator and a valve body with internal variable size orifice. When operating, the PCB will send pulses of voltage to the electrical operator. The operator will then magnetically move the position of the metering orifice pin to vary refrigerant flow.

The metering device position is determined by input from a Suction Line Temperature Sensor. The EEV will change the internal orifice size to maintain an acceptable level of superheat.

During COOL MODE the valve meters low pressure refrigerant to the indoor coil. During HEAT MODE the valve meters low pressure refrigerant to the outdoor coil.

The electrical expansion valve is electrically connected to the Main Control Board at PLUG CN-16.

Accumulator



The Accumulator is located in the suction line circuit at the entrance to the compressor. The accumulator helps prevent liquid refrigerant from entering the compressor during run operation.

Refrigerant Strainers



The system has debris-catching strainers that protect internal system components from contaminants in the refrigerant. The strainer is a permanent part that is not typically replaced.

Base Pan Heater



The Base Pan Heater is electrically connected to the Main Control Board at PLUG CN-48.

Cooling mode

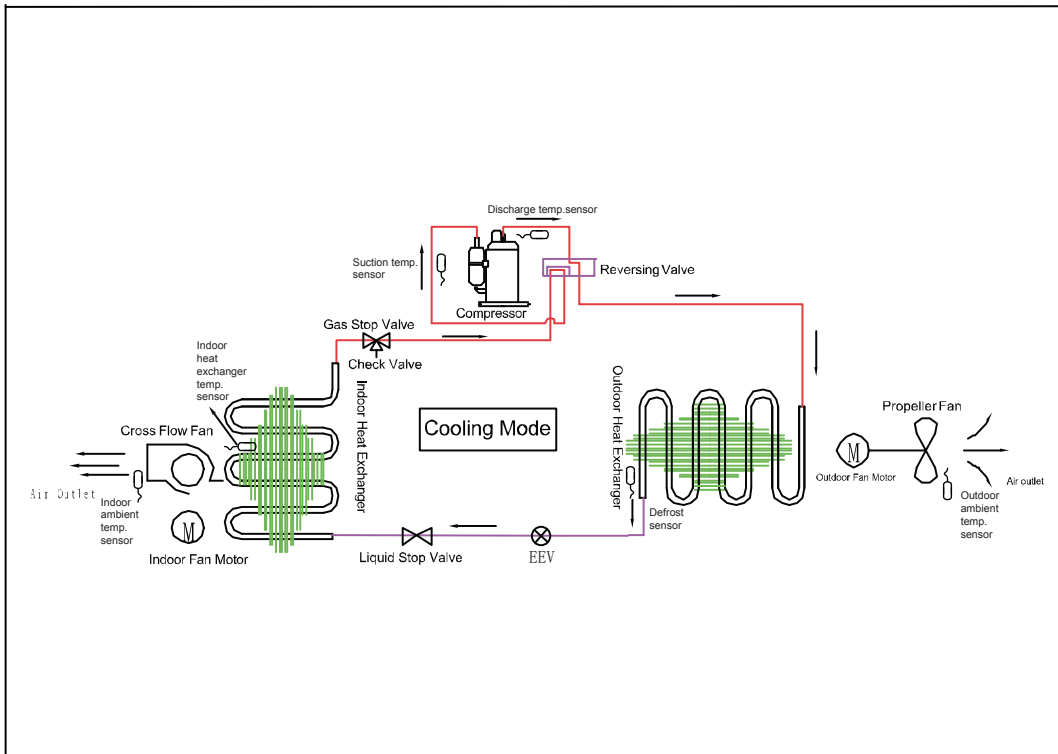

Heating mode

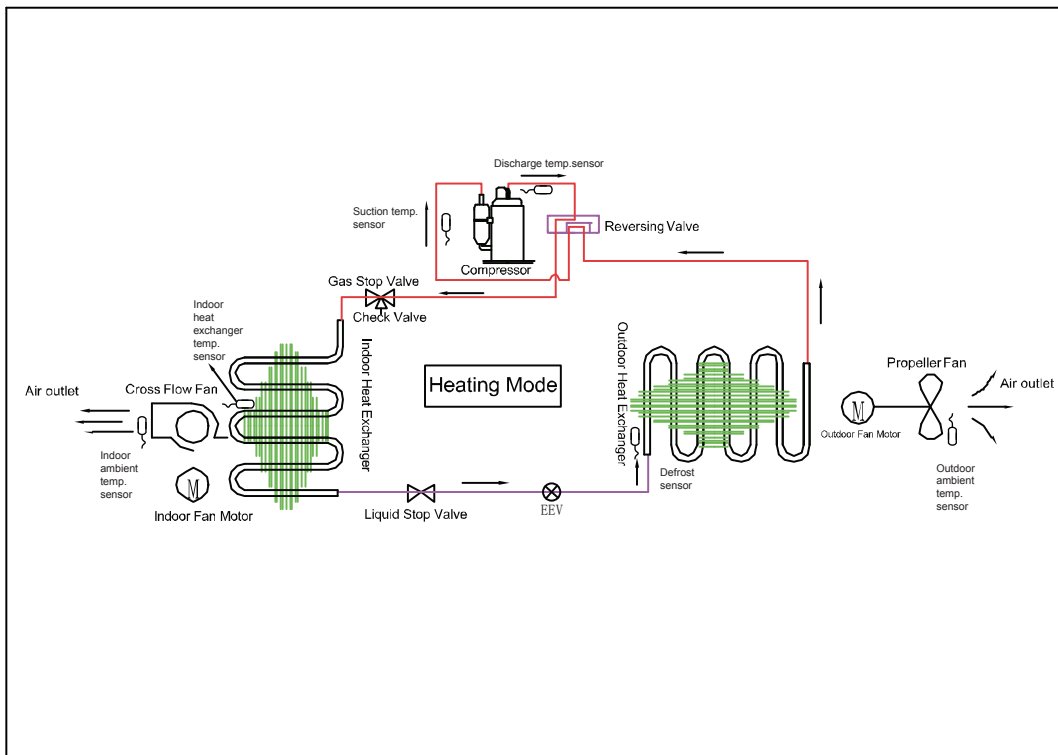

OUTDOOR UNIT WIRING DIAGRAM

0011509127

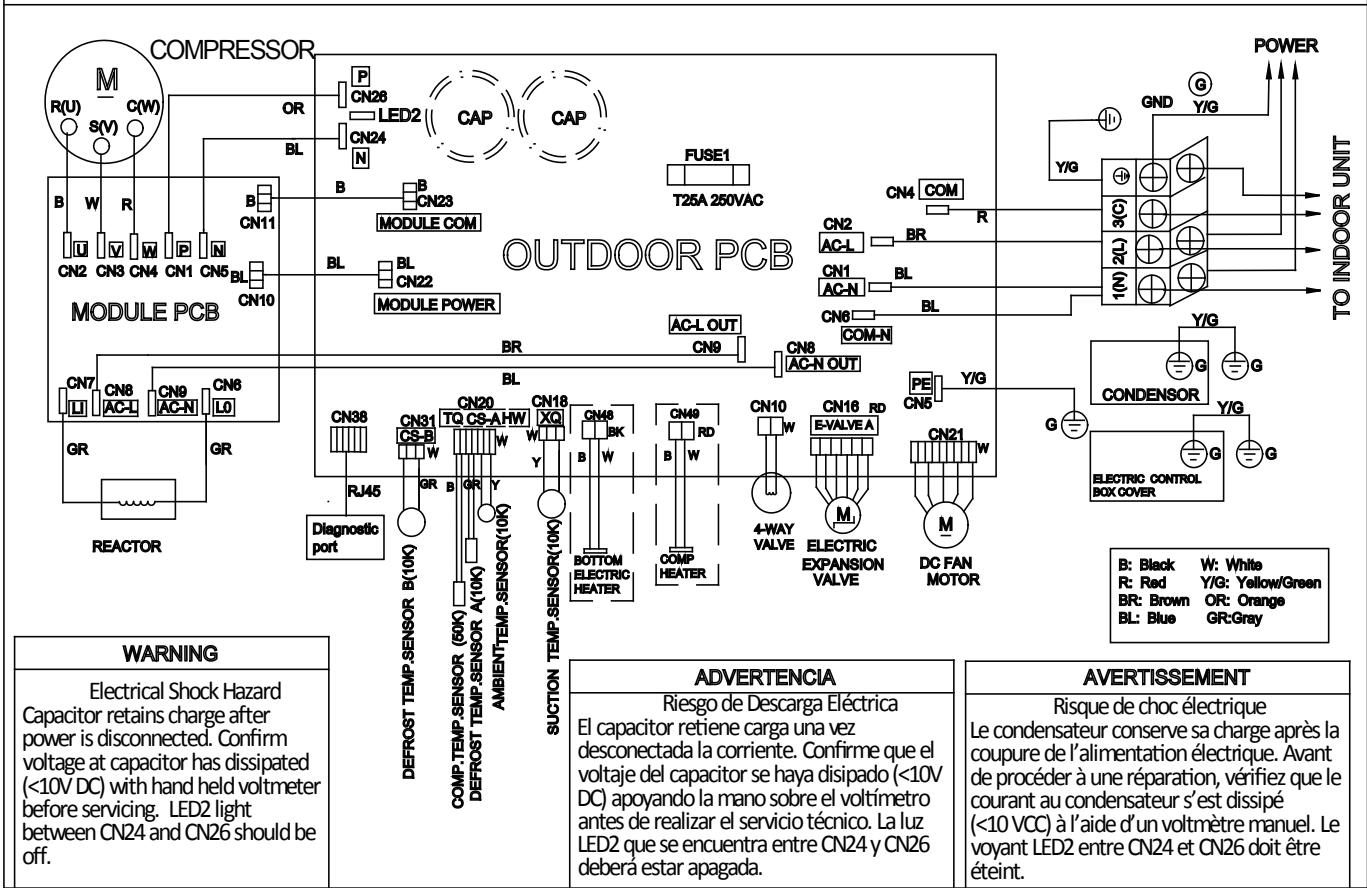

WARNING

Electrical Shock Hazard
Capacitor retains charge after power is disconnected. Confirm voltage at capacitor has dissipated (<10V DC) with hand held voltmeter before servicing. LED2 light between CN24 and CN26 should be off.

ADVERTENCIA

Riesgo de Descarga Eléctrica
El capacitor retiene carga una vez desconectada la corriente. Confirme que el voltaje del capacitor se haya disipado (<10V DC) apoyando la mano sobre el voltímetro antes de realizar el servicio técnico. La luz LED2 que se encuentra entre CN24 y CN26 deberá estar apagada.

AVERTISSEMENT

Risque de choc électrique
Le condensateur conserve sa charge après la coupure de l'alimentation électrique. Avant de procéder à une réparation, vérifiez que le courant au condensateur s'est dissipé (<10 VCC) à l'aide d'un voltmètre manuel. Le voyant LED2 entre CN24 et CN26 doit être éteint.

OUTDOOR UNIT WIRING DIAGRAM

0011509127A

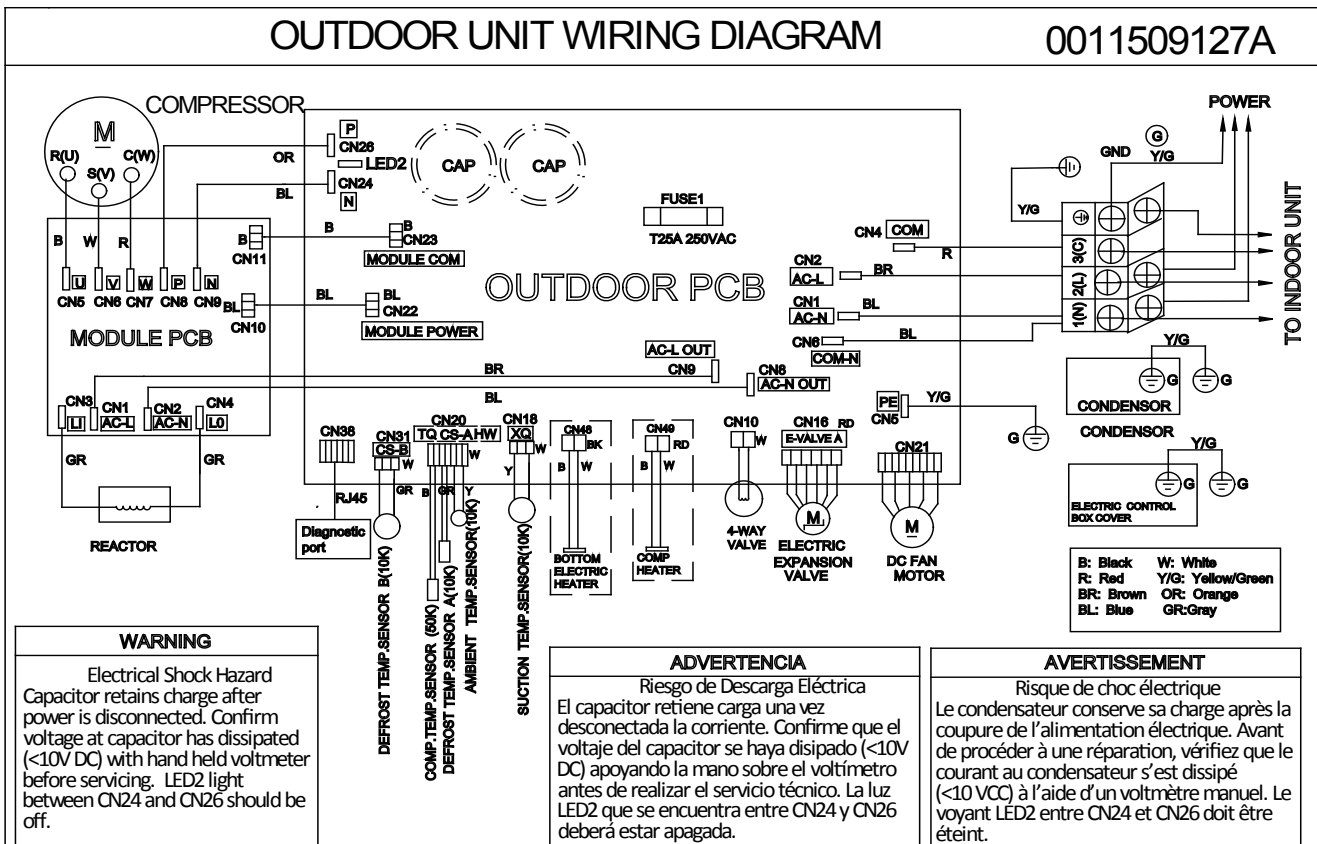

WARNING

Electrical Shock Hazard
Capacitor retains charge after power is disconnected. Confirm voltage at capacitor has dissipated (<10V DC) with hand held voltmeter before servicing. LED2 light between CN24 and CN26 should be off.

ADVERTENCIA

Riesgo de Descarga Eléctrica
El capacitor retiene carga una vez desconectada la corriente. Confirme que el voltaje del capacitor se haya disipado (<10V DC) apoyando la mano sobre el voltímetro antes de realizar el servicio técnico. La luz LED2 que se encuentra entre CN24 y CN26 deberá estar apagada.

AVERTISSEMENT

Risque de choc électrique
Le condensateur conserve sa charge après la coupure de l'alimentation électrique. Avant de procéder à une réparation, vérifiez que le courant au condensateur s'est dissipé (<10 VCC) à l'aide d'un voltmètre manuel. Le voyant LED2 entre CN24 et CN26 doit être éteint.

1U09EH2VHE1
ASH109URDSE1

J1	J2	SW1-1	SW1-2
ON	ON	OFF	OFF
ON	OFF	—	—
OFF	ON	—	—
OFF	OFF	—	—

1U12EH2VHE1
ASH112URDSE1

J1	J2	SW1-1	SW1-2
ON	ON	OFF	OFF
ON	OFF	—	—
OFF	ON	—	—
OFF	OFF	—	—

1U18EH2VHE1
ASH118URDSE1

J1	J2	SW1-1	SW1-2
ON	ON	OFF	OFF
ON	OFF	—	—
OFF	ON	—	—
OFF	OFF	—	—

Indoor Unit Display

Error codes will be display on the indoor unit in place of the set temperature.

	Code Indication		Fault Description
	Indoor Display panel code indication	Outdoor (LED1 flash times)	
	Other display		
Indoor and Outdoor	E7	15	Communication fault between indoor and outdoor units
Indoor Malfunction	E1	--	Room temperature sensor failure
	E2	--	Heat-exchange sensor failure
	E4	--	Indoor EEPROM error
	E14	--	Indoor fan motor malfunction
Outdoor Malfunction	F12	1	Outdoor EEPROM error
	F1	2	The protection of IPM
	F22	3	Overcurrent protection of AC electricity for the outdoor model
	F3	4	Communication fault between the IPM and outdoor PCB
	F19	6	Power voltage is too high or low
	F4	8	Overheat protection for Discharge temperature
	F21	10	Defrost temperature sensor failure
	F7	11	Suction temperature sensor failure
	F6	12	Ambient temperature sensor failure
	F25	13	Discharge temperature sensor failure
	F11	18	deviate from the normal for the compressor
	F28	19	Loop of the station detect error
	F2	24	Overcurrent of the compressor
	F23	25	Overcurrent protection for single-phase of the compressor

Table of Contents

Indoor Unit Introduction 21
Indoor Component Identification 21
Indoor Control Board..... 22
Terminal Block..... 23
Display 23
Ambient Temperature Sensor 23
Piping Temperature Sensor 23
Louver Motor 24
Fan Motor 24
Emergency Button 24
DIP Switch and DIP Switch Settings 25

Indoor Unit Introduction

The indoor unit is mounted high on the wall to provide comfort and air movement within the conditioned space. Features of the system include: Variable speed blower operation that speeds up and slows down with changes in demand, moving louvers to direct air, indoor air temperature sensing, evaporator coil temperature sensing, a status display, evaporator coil with metering device located in outdoor unit, and an emergency operation button.

Indoor Component Identification

- | | | | |
|---|----------------------------|---|----------------------------|
| 1 | Ambient Temperature Sensor | 6 | Piping Temperature Sensor |
| 2 | Display | 7 | Wired Controller Interface |
| 3 | Fan Motor | 8 | Terminal Block |
| 4 | Louver Motor | 9 | Occupancy Sensor |
| 5 | PCB | | |

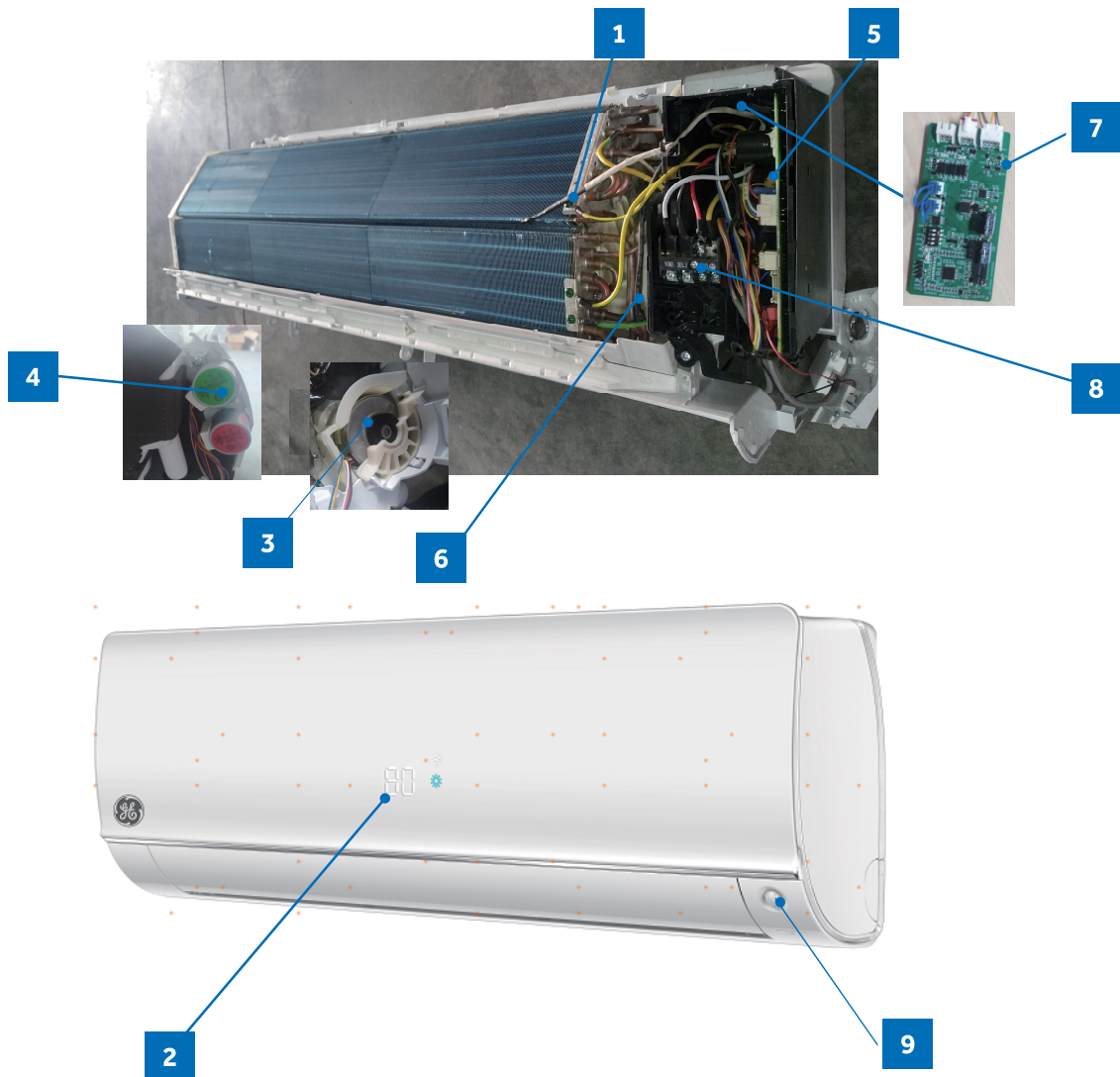

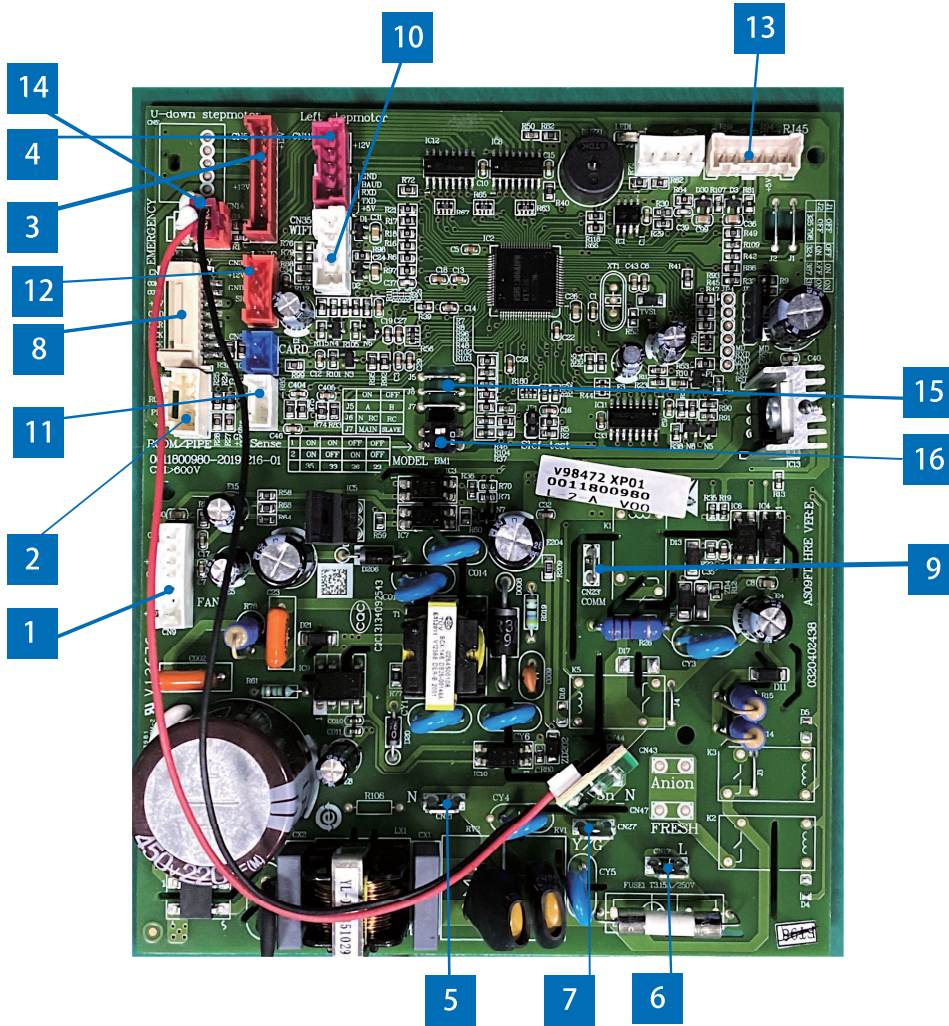

- | | |
|--|---|
| 1 CN9-Connector for fan motor | 10 CN35-Connector for WiFi module |
| 2 CN6-Connector for coil temperature sensor and room temperature sensor | 11 CN56-Connector for occupancy sensor |
| 3 CN5-Connector for UP/DOWN STEP motor | 12 CN34-Connector for wired controller interface |
| 4 CN11-Connector for LEFT/RIGHT STEP motor | 13 CN38-Connector for diagnostic port |
| 5 CN21-Connector for power N | 14 CN14-Connector for forced operation ON / OFF switch |
| 6 CN17-Connector for power L | 15 J5-Select remote code A or B
J6-Select room card able or disable |
| 7 CN27-Connector for GND | 16 BM1 1-2 Select 23, 26, 33, or 35 |
| 8 CN7-Connector for display board | |
| 9 CN23-Communication connection between the PCB and the outdoor unit | |

Terminal Block

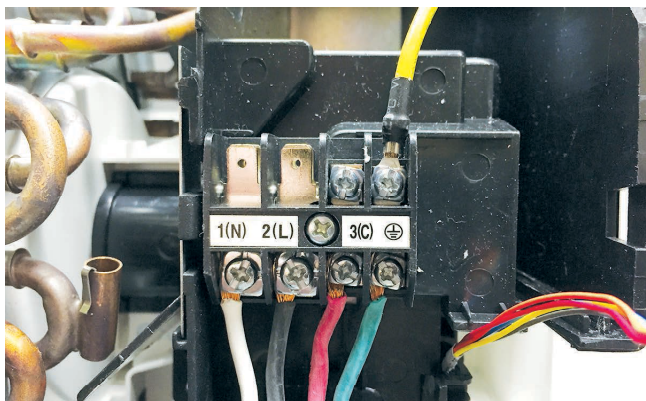

The unit terminal block receives electrical power from the outdoor unit. There are 4 connections for electrical wires. Terminals 1 and 2 are connected to terminals 1 and 2 of the outdoor unit. This wiring supplies power to the indoor unit.

Terminal 3 is a communication wire. The indoor unit sends indoor air temperature, coil temperature and temperature setpoint information to the outdoor unit on this wire. If a splice or break in this wire is present, the indoor unit will not be able to communicate with the outdoor unit. The ERROR CODE will be an E7.

Display

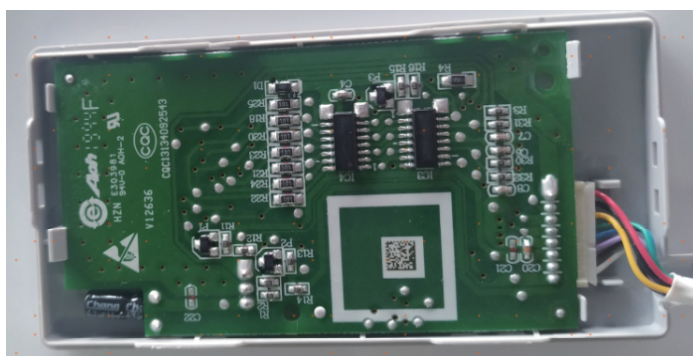

The indoor display has an infrared communication circuit that receives operating commands from the remote control. This display will indicate operating modes, error codes, indoor air temperature, timer status, and power status.

Ambient Temperature Sensor



The Ambient (room) Temperature Sensor is a negative coefficient thermistor that will decrease in resistance with increases in room air temperature. The sensor is located on a clip mounted in the return air stream.

The sensor connects to the control board at Plug CN-6.

Piping Temperature Sensor

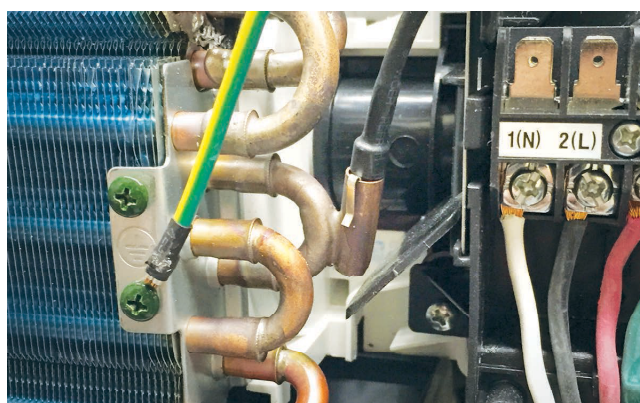

The Piping Temperature Sensor is a negative coefficient thermistor that will decrease in resistance with increases in coil temperature. The sensor is located in a socket soldered to the surface of the indoor coil.

This sensor will monitor the temperature of the indoor coil in both cooling and heating modes of operation. Should abnormally cold or hot coil temperature be detected by this sensor, the system will take steps to correct the condition or report an ERROR CODE.

The sensor connects to the control board at Plug CN-6.

Stepper Motor



The STEPPER MOTOR moves the louver up and down, or right and left, depending upon selections made at the remote control.

These motors are connected at CN5 and CN11.

Emergency Button



If the remote control is non-functional, the Emergency Button can be used. 73 -78 degrees will be maintained, until commands are received via the remote control.

Fan Motor



The Fan Motor is a variable speed motor. The air volume will vary with the speed of the compressor, or it can be set at the remote control to maintain a single speed.

The Fan Motor is connected to the indoor control board via PLUG CN-9.

DIP Switch

DIP Switch Settings

The PCB has a set of DIP switches that must be set when replacing the PCB.

The replacement PCB is shipped with all switches set to the OFF position.

Switch settings:

J5 Selects remote code A or B. Normally set to connection state for code A operation.

If two indoor units are used in the same area and the user wishes to control them separately, switch J5 of the second unit is set to be cut off for code B operation. The wireless remote for the second unit is also set to code B.

J6 Selects room card able or disable. Normally set to connection state. Set to the disconnected state when used in conjunction with a room card interface utilized in hotel rooms.

SW-1 and SW-2 Selects EEPROM codes 23, 26, 33 and 35. Set to identify the tonnage of the unit.

Settings:

9K	(23)	SW-1	OFF	SW-2	OFF
12K	(26)	SW-1	OFF	SW-2	ON
18K	(33)	SW-1	ON	SW-2	OFF

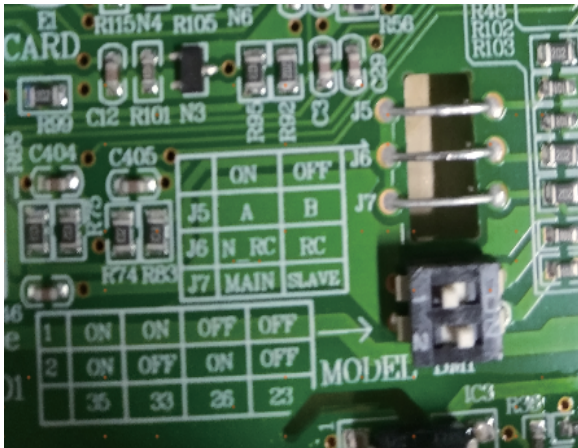

INDOOR UNIT DIAGRAM

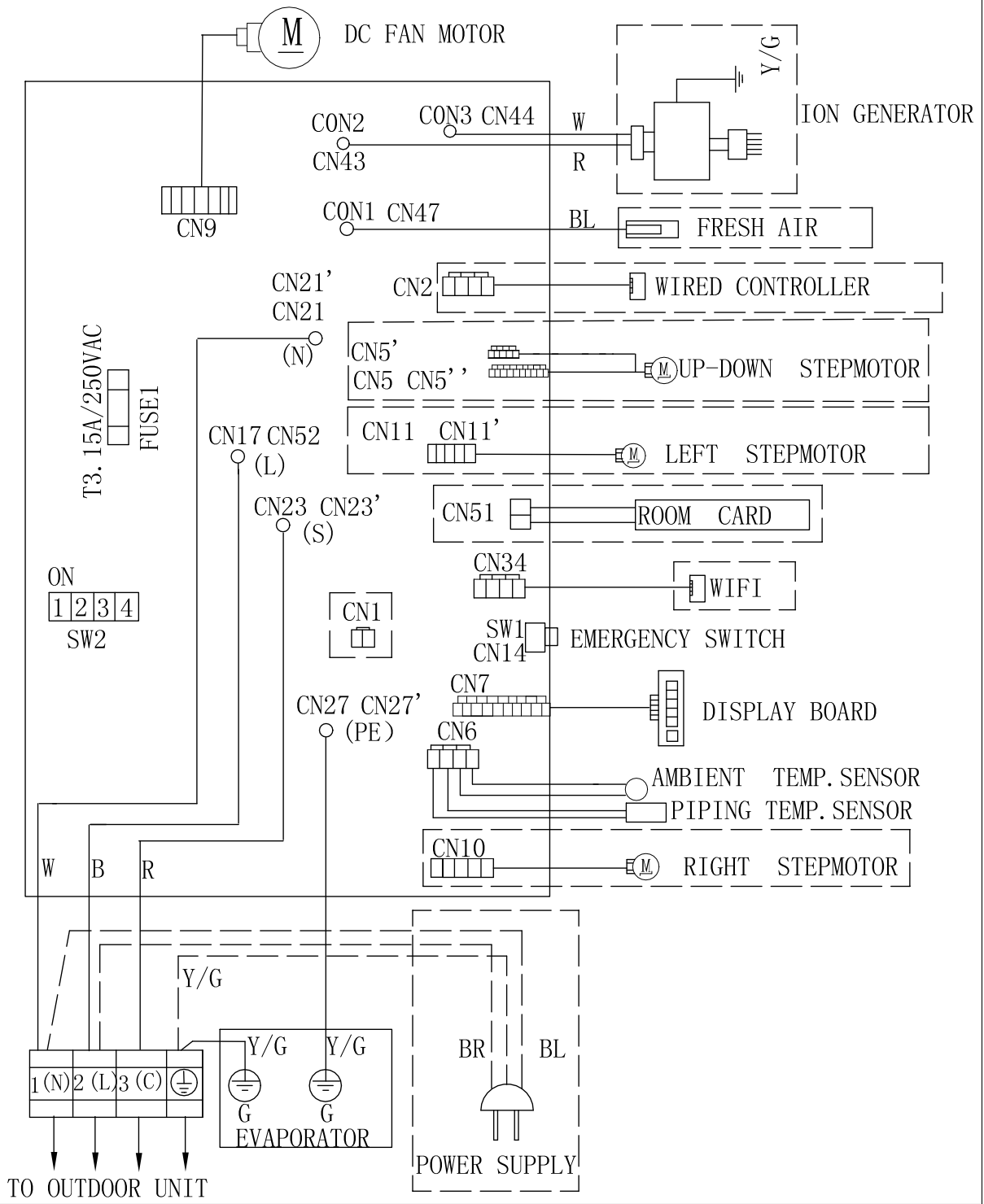

Notes:

1. The dotted parts are optional.
2. The two pins of CN51 should be shorted, when the second channel (RC) of SW2 is selected.

R:Red B:Black
 W:White BL:Blue
 Y:Yellow BR:Brown
 Y/G:Yellow/Green

Error Codes

The error codes that are displayed on the indoor units may vary from the outdoor unit codes. The information communicated by the error code will be the SAME for both indoor and outdoor units even though the numbers may differ.

Indoor Display	Outdoor LED	Diagnosis
F12	1	Outdoor EEPROM failure
F1	2	IPM overcurrent or short circuit
F22	/	Outdoor alternating current, over current protection
F3	4	Communication failure between the IPM and outdoor PCB
F20*	5	Module operated overload (compressor overload protection)
F19*	6	Module low or high voltage
F27	/	Compressor current sampling circuit fault
F4	8	Overheat protection for discharge temperature
F8*	9	Malfunction of the DC fan motor
F21	10	Malfunction of defrost temperature sensor
F7	11	Suction temperature sensor failure
F6	12	Ambient temperature sensor failure
F25	13	Discharge temperature sensor failure
F30*	/	High outdoor suction temperature
E7	15	Communication failure between the indoor & outdoor unit
F13*	16	Lack of refrigerant or discharging
F14*	17	4-way valve switching failure
F11	18	Loss of synchronism detection
F28	/	Position detection circuit fault of compressor
F15*	/	Terminal block temp too high
E9	20	Indoor thermal overload
E9*	21	Indoor unit overload protection, heating mode only.
E5	21	Indoor coil frosted
E5*	/	Indoor anti-frosting protection
F5*	23	Module thermal overload
F2*	24	Compressor start failure, over-current
F23*	25	Phase current protection (IPM)
F9	26	MCU reset
F24	27	Module current detect circuit malfunction
F10	28	Liquid pipe sensor failure: Circuit A
F16	29	Liquid pipe sensor failure: Circuit B
F17	30	Liquid pipe sensor failure: Circuit C
F18	31	Liquid pipe sensor failure: Circuit D
F29	32	Gas pipe sensor failure: Circuit A
F30	33	Gas pipe sensor failure: Circuit B
F31	34	Gas pipe sensor failure: Circuit C
F32	35	Gas pipe sensor failure: Circuit D
F26	36	Gas pipe sensor failure: Circuit E
F34	/	Outdoor pipe temperature protection in cooling mode
F35	38	Malfunction of module temperature sensor momentary power failure detection
F36	39	Malfunction of condensing temperature sensor
F33	40	Liquid pipe sensor failure: Circuit E
F38	41	Toci temperature sensor failure
F39	42	High Pressure switch open
F40	43	Low Pressure switch open
F41	44	System high pressure protection: Overcharged, high condensing temperature or malfunction of fan motor.
F42	45	System low pressure protection: Undercharged, low defrosting temperature, or malfunction of fan motor.
F43	/	Incorrect match between indoor & outdoor
E1	/	Indoor ambient temperature sensor failure
E2	/	Indoor coil temperature sensor failure
E4	/	Indoor PCB EEPROM failure
E14*	/	Indoor fan motor malfunction

* Hidden indoor error code. LED1 will flash outdoors, but no error will appear on indoor unit display. To view error code on indoor display, press and hold the Emergency button for 15 seconds.



AB09SC2VHA
 AB12SC2VHA
 AB18SC2VHA

Table of Contents

Components..... 29

 Component Overview 29

 Cassette Unit Indoor Circuit Board..... 31

Testing..... 32

 Accessing the Blower Motor and Condensate Pump 32

 Removing Fan Motor 32

 Removing Condensate Pump 32

 Indoor Fan Motor Test Procedure 33

 Testing Temperature Sensors 33

 Testing Louver Motors 34

 Testing Communication Circuit 34

 Test Condensate Pump and Associated Float Switch 35

Wiring Diagram & DIP Switch Settings.....36

Error Codes..... 37

Components

The indoor cassette type units act as evaporator coils during cooling mode and condenser coils during heating mode. These units have a built in condensate pump with an associated condensate level switch. The condensate pump is capable of lifting water out of the indoor unit. If high water lift is needed, the water from the cassette pump should be pumped into a field supplied condensate pump with high lift power.

Cassette type indoor units can be operated with a wired controller or a remote control.

Component Overview



1 Terminal Block

Power to operate the indoor unit comes from the electrical line voltage terminal block at the outdoor unit. The wiring includes 4 wires, 1, 2, 3 and ground. Wires 1 and 3 complete the data path. These wires should always be 14 gauge AWG Stranded type wire. Splices in wires 1 or 3 may cause communication errors.

2 Motor Blower

The indoor unit features a multi speed blower motor that will change speed to match the capacity demand from the outdoor unit. Separate motors located in the indoor unit control the operation of the motorized louvers. All of the louver motors are controlled via commands received from the remote control. The blower motor is controlled by both the remote control and by commands from the outdoor unit ECU.

3 Display

The indoor unit has a display that communicates system mode. The indoor unit does not display temperatures or diagnostic codes. When a wired controller is used, this information is displayed on the wired controller. It is recommended to use a wired controller with the cassette unit.

When servicing a diagnostic error, ALWAYS refer to the outdoor unit code to make diagnostic decisions.

4 The Blower Assembly

The blower assembly consists of a plastic blower wheel that is connected to a PSC indoor blower motor. A set screw holds the blower wheel to the blower motor.

The indoor blower motor is a Multi Speed Fan Motor that is connected to the indoor unit control board. The wiring from the motor to indoor board consists of 4 wires connected to pins common, low, medium and high speeds.

During normal operation, the indoor control board will energize the indoor blower motor and request proper speed. The motor has a run capacitor that is located in the Cassette unit's control box. The run capacitor connects to the motor via two orange wires. This capacitor is field replaceable.

5 Louver Motors

The louver motors are stepper type motors that move the louvers up/down. The motors are controlled by pulsed voltage that cannot be measured. If the louver does not move when it should, check for a bind in the louvers.

6 Piping Temperature Sensor

The Piping Temperature Sensor senses indoor coil temperature in the cooling mode and in the heating mode. This sensor is used for Anti Freezing and Anti Cold Blow cycles. The sensor also provides critical temperature information to the ECU that may be used in frequency adjustments.

7 Ambient Temperature Sensor

The Ambient Temperature Sensor senses room temperature. This sensor provides room temperature information to the ECU for calculation of inverter capacity and temperature control.

Both sensors are negative temperature coefficient type that reduce electrical resistance as temperature rises.

8 Control Board

The indoor unit circuit board controls the switching functions of the indoor unit. All control decisions are made by the outdoor unit ECU. The indoor board has some limited diagnostic capability which will be covered in this manual.

9 Condensate Pump & Float Switch

1. If in COOL or DRY mode: Compressor running (Thermal ON), then condensate pump is energized
 - When compressor stops (Thermal OFF), condensate pump runs for an additional 5 minutes
2. If in COOL or DRY modes and compressor is running (Thermal ON) and the float switch opens for 5 minutes
 - Compressor will stop, the pump will continue to run
 - If the float switch does not close, error code will display and pump continues to run
 - If the float switch does close, the pump will continue to run for 5 additional minutes
3. During standby (Thermal OFF) in COOL/DRY modes or in HEAT and FAN modes and float switch opens for 2 seconds, the condensate pump is energized.
 - If the float switch closes, the pump will run an additional 5 minutes
 - If the float does not close, the pump continues to run and error code is displayed

Components

Cassette Unit Indoor Circuit Board

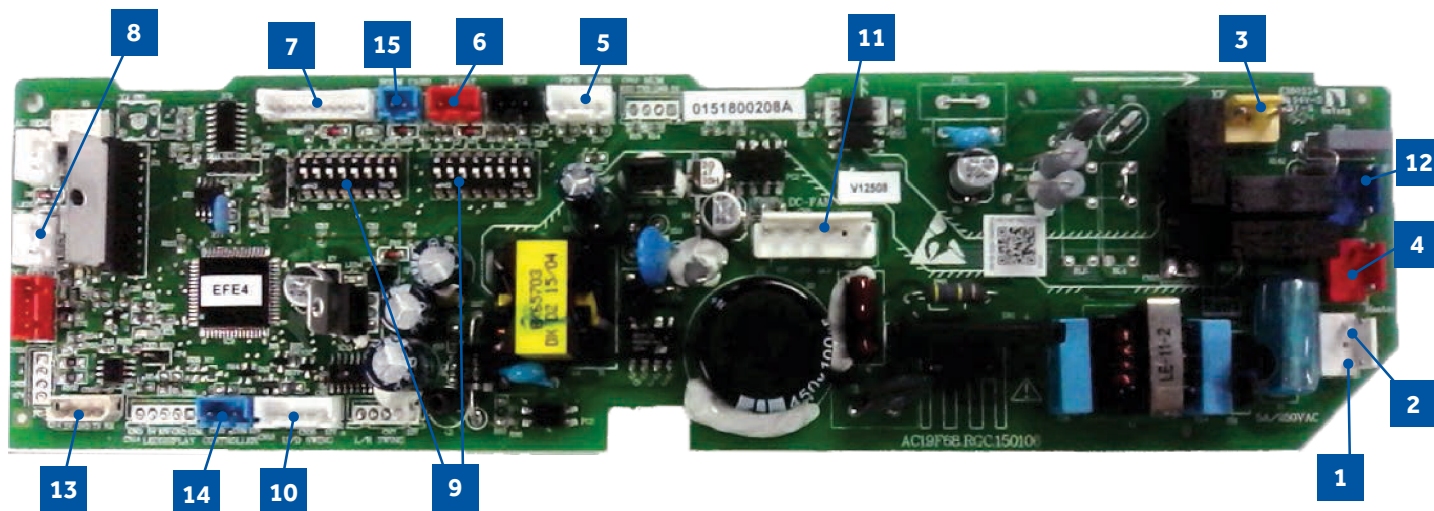

- | | | |
|-------------------------------------|------------------------------|-------------------------------|
| 1 N Terminal | 6 CN19 Float Switch | 11 CN6 Fan Motor |
| 2 L Terminal | 7 CN21 Louver Panel | 12 CN9 Condensate Pump |
| 3 Communication Terminal | 8 CN11 Wired Remote | 13 CN4 U-HOME |
| 4 3.15A 250V Fuse | 9 DIP Switches | 14 CN13 Remote Central |
| 5 CN3 Pipe/Room Temp Sensors | 10 CN35 Stepper Motor | 15 CN1 Room Card |

The indoor unit circuit board controls the switching functions of the indoor unit. All control decisions are made by the outdoor unit ECU. The indoor board has some limited diagnostic capability which will be covered in this manual.

The Indoor Unit Circuit Board communicates with the outdoor unit ECU via a connection at Terminal Block screw 3. The data pulse that sends the communication information can be measured with a voltmeter placed to DCV range. From the ground connection at the Terminal Block to the Number 3 screw connection, the voltage should pulse up and down when data is being transmitted.

This control board has control over the fan louver movement, manual fan blower control, indoor coil temperature and indoor air temperature sensing functions. All operational decisions are controlled by the OUTDOOR UNIT ECU.

The connections on the indoor board are shown here in the schematic drawing.

Line voltage to power the indoor unit comes in on Terminal Block connections 1 and 2. Power connects from these terminal connections to CH- 3 and CH-4 on the circuit board. If the board does not respond to commands and has no display, check for line voltage at these connections. When power is present at the indoor board, the Display Power Indicator will be lit.

The control board has a replaceable 3.15A 250V fuse that protects against excessive current. If power is present at the board but the board does not work, check for continuity through the fuse. Replace if the fuse is open.

The indoor unit temperature sensors are connected at Plug CN-13. When testing the calibration of these sensors, the wires can be released from the plug by pressing on the tension tab on the side of the plug.

The receiver/display unit that is mounted to the front cover of the indoor unit plugs into the circuit board via a connection at Plug CN-29.

There is one motor that controls the movement of the louvers. The motor connects to the circuit board at Plug CN-14. The motor is located in the over of the louver assembly.

The blower/fan motor is connected to the circuit board at plug CN-11.

The Cassette unit has a built in condensate pump. The pump is connected to the circuit board on Plug CN-9. The pump is energized whenever the Float Switch indicates that water needs to be pumped from the cassette. The float switch connects onto the circuit board via Plug CN-18.

Accessing the Blower Motor and Condensate Pump

1. Disconnect power to the outdoor unit.
2. Remove the louver assembly



3. Disconnect the main power wire of the indoor unit.
4. Unplug the condensate pump and float switch from wiring harness
5. Unplug fan motor from wiring harness
6. Remove ground wire from ground screw on electrical box. Remove electrical box.
7. Remove 5 screws holding foam condensate pan bottom in place.



8. Slide condensate pan from cassette

Removing Fan Motor

1. Remove holding nut from fan blade



2. Fan blade will slide off motor shaft.
3. Remove Phillips head screw holding cover plate over motor wiring leads
4. Remove 3 nuts that hold fan motor in place



5. Fan motor will come loose

Removing Condensate Pump

1. Remove screws holding condensate pump and float switch in position.
2. Disconnect condensate hose from condensate pump
3. Remove assembly

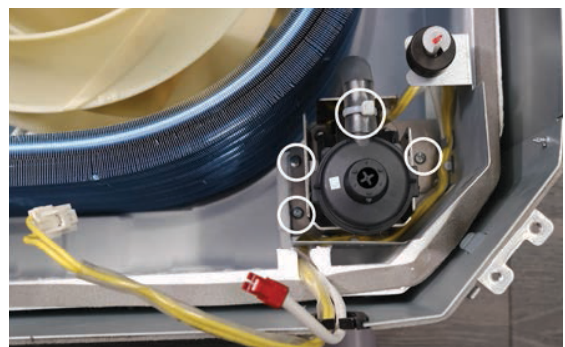

Indoor Fan Motor Test Procedure

If the indoor fan motor does not run:

1. Disconnect power to the system.
2. Remove the return air cover and access the circuit board connection.
3. Reset power and turn the remote control fan command to Fan On mode.

Motor Test:

1. If the motor doesn't run, check for 310VDC between Pins 1 and 3. If it is not present, the indoor board is bad. If voltage is present, continue on.
2. Check the voltage between Pins 3 and 4. The voltage should be +15VDC. If it is not present, the board is bad. If voltage is present, continue on.
3. Check for voltage between Pins 3 and 6. If no DC voltage is present, the board is bad. If voltage is present, change the motor.

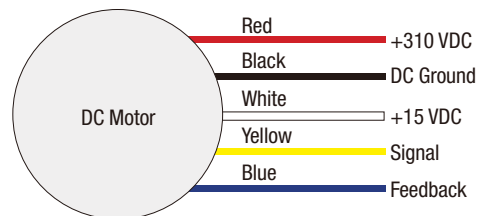

Testing Temperature Sensors

The easiest problems to solve will involve codes that are related to potential failure of temperature sensors. Common problems may include loose connections, open electrically, and out of calibration. Checking the condition of the sensors requires a temperature probe and an ohmmeter.

The Reference Section of this manual contains temperature resistance tables that can be used to check the calibration of the sensors. The measured resistance must be within the tolerances printed on the top of the tables.

To test the electrical condition of a temperature sensor perform the following:

1. Confirm the sensor is firmly attached to the circuit board connection plug.
2. Remove the sensor wires from the connection plug by releasing holding tension on the plugs tension tab.
3. Use an ohmmeter to test the electrical resistance of the sensor.
4. Measure the air temperature near the sensor and compare the required resistance against measured resistance. (See chart in reference section) If the sensor is within calibration, the sensor is good. If the sensor is out of calibration, replace the sensor. (Tube Sensors should be removed from socket and exposed to air temperature during test.)

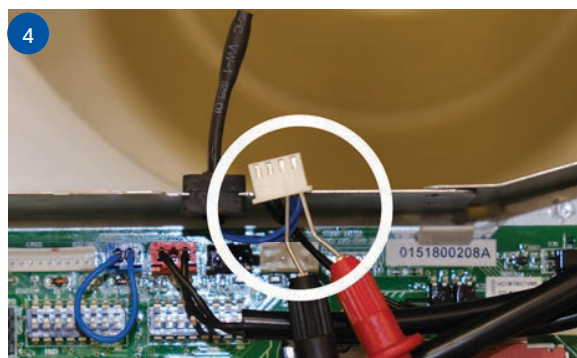

Testing Louver Motors

If the louver does not operate with command from the remote control, either the indoor board is bad, or the louver motor is defective. It is more likely the motor is defective than the board. (Make sure the louver assembly is not binding and keeping the vanes from moving.)

1. Remove power from the unit and remove the indoor unit cover.
2. Access the circuit board.



3. Identify the inoperable louver motor on the schematic drawing below and disconnect the plug from the circuit board.

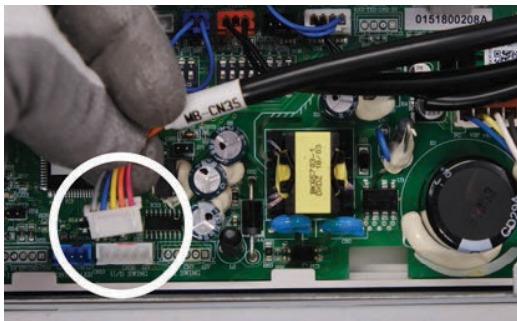
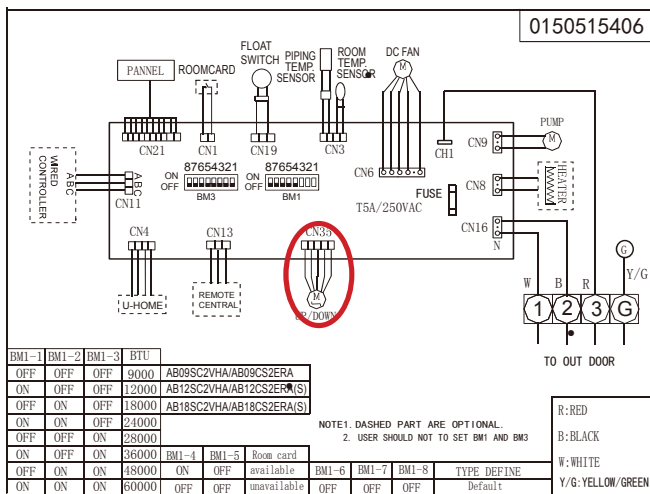

4. Use an Ohmmeter to test the electrical continuity of the louver motor windings. The proper resistance for each winding can be found in this table. If the motor winding resistance is erratic or shows open, the motor is defective. Replace the motor.



5. If the motor checks out good, replace the indoor control board.

Testing Communication Circuit

If an Error E7 occurs, perform the following test to determine if the indoor control board is functioning properly to send data to the outdoor unit.

Perform this test with the unit powered and all wiring connected between indoor and outdoor unit.

Make sure all wiring between the indoor and outdoor unit are correct. There should no splices between the indoor and outdoor unit wiring connecting terminals 1 or 3. Make sure wiring is correct, before performing this test.

1. Measure the DC voltage between terminals 1 and 3 on the indoor terminal block.



2. The voltage should fluctuate between 8VDC and 23VDC. The fluctuating signal indicates a good communication path.
3. If the voltage does not fluctuate, and the wiring is good, the indoor board is defective.

Test Condensate Pump and Associated Float Switch

If the internal condensate pump does not operate, the pump may be bad or the float switch may be defective. Perform the following test:

1. Access the electrical control box.
2. Unplug the float switch from the circuit board.
3. The pump should start.
4. If the pump does not start, check for voltage at the pump connector on the board. There should be 230 Volts AC to the pump. If there is not, the circuit board is defective. If there is proper voltage to the pump, either the pump or associated pump wiring is defective.

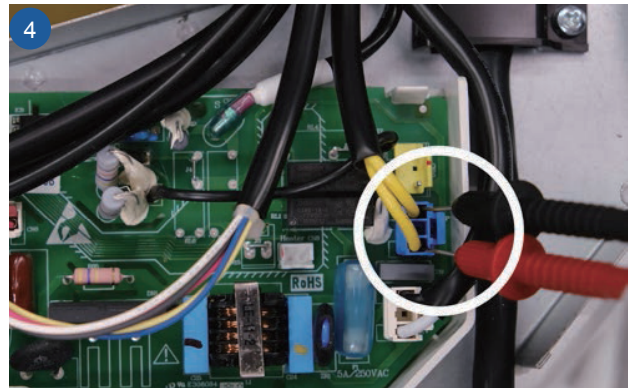

5. When installing, the condensate discharge port at the top of the water pump must be connected with drain pipe.

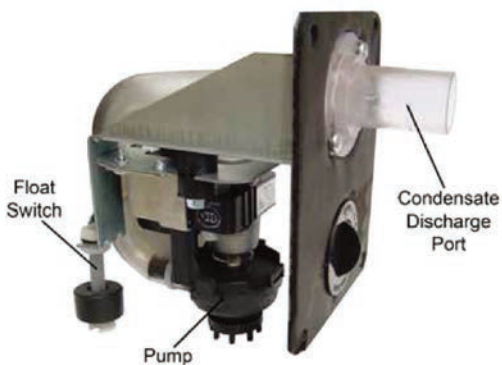

Wiring Diagram & DIP Switch Settings

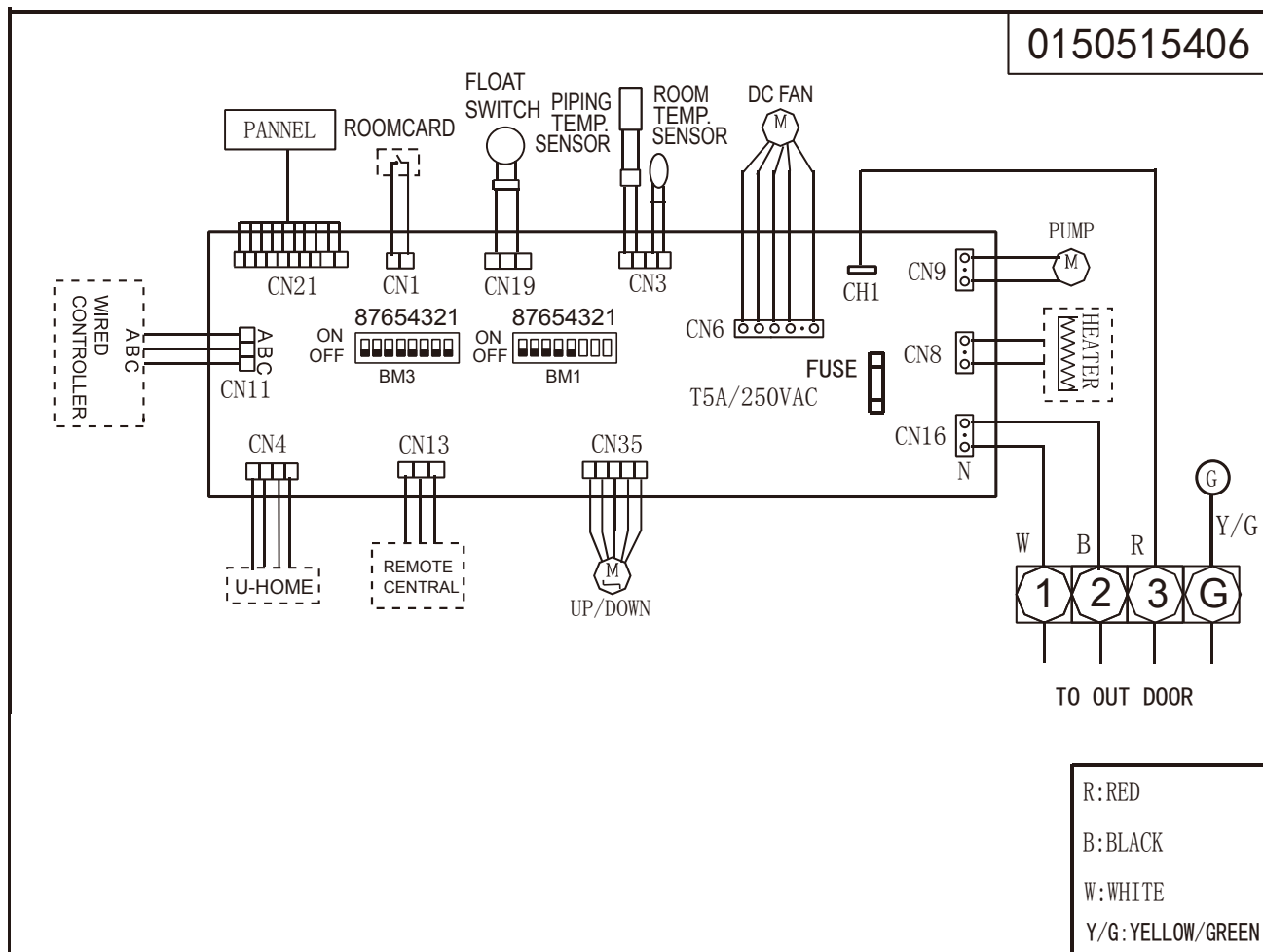

Cassette Unit DIP Switch Settings

BM1-1	BM1-2	BM1-3	BM1-4	BM1-5	BM1-6	BM1-7	BM1-8	Description
OFF	OFF	OFF	--	-	--	-	--	Unit capacity: 9000
ON	OFF	OFF	--	-	--	-	--	Unit capacity: 12000
OFF	ON	OFF	--	-	--	-	--	Unit capacity: 18000
-	--	-	OFF	-	--	-	--	Room card invalid(default)
-	--	-	ON	-	--	-	--	Room card valid
-	--	-	--	OFF	--	-	--	Heat pump(default)
-	--	-	--	ON	--	-	--	Cooling only
-	--	-	--		OFF	OFF	OFF	Cassette(American)

Error Codes

The error codes that are displayed on the indoor units may vary from the outdoor unit codes. The information communicated by the error code will be the SAME for both indoor and outdoor units even though the numbers may differ.

Indoor LED5	Indoor LED1	Outdoor LED	Diagnosis
2	1	1	Outdoor EEPROM failure
2	2	2	IPM overcurrent or short circuit
2	3	/	Outdoor alternating current, over current protection
2	4	4	Communication failure between the IPM and outdoor PCB
2	5	5	Module operated overload (compressor overload protection)
2	6	6	Module low or high voltage
2	7	/	Compressor current sampling circuit fault
2	8	8	Overheat protection for discharge temperature
2	9	9	Malfunction of the DC fan motor
3	0	10	Malfunction of defrost temperature sensor
3	1	11	Suction temperature sensor failure
3	2	12	Ambient temperature sensor failure
3	3	13	Discharge temperature sensor failure
3	4	/	High outdoor suction temperature
3	5	15	Communication failure between the indoor & outdoor unit
3	6	16	Lack of refrigerant or discharging
3	7	17	4-way valve switching failure
3	8	18	Loss of synchronism detection
3	9	/	Position detection circuit fault of compressor
4	0	/	Terminal block temp too high
4	0	20	Indoor thermal overload •
4	1	21	Indoor unit overload protection, heating mode only.
4	1	21	Indoor coil frosted
4	2	/	Indoor anti-frosting protection
4	3	23	Module thermal overload
4	4	24	Compressor start failure, over-current
4	5	25	Phase current protection (IPM)
4	6	26	MCU reset
4	7	27	Module current detect circuit malfunction
4	8	28	Liquid pipe sensor failure: Circuit A
4	9	29	Liquid pipe sensor failure: Circuit B
5	0	30	Liquid pipe sensor failure: Circuit C
5	1	31	Liquid pipe sensor failure: Circuit D
5	2	32	Gas pipe sensor failure: Circuit A
5	3	33	Gas pipe sensor failure: Circuit B
5	4	34	Gas pipe sensor failure: Circuit C
5	5	35	Gas pipe sensor failure: Circuit D
5	6	36	Gas pipe sensor failure: Circuit E
5	7	/	Outdoor pipe temperature protection in cooling mode
5	8	38	Malfunction of module temperature sensor momentary power failure detection
5	9	39	Malfunction of condensing temperature sensor
6	0	40	Liquid pipe sensor failure: Circuit E
6	1	41	Toci temperature sensor failure •
6	2	42	High Pressure switch open
6	3	43	Low Pressure switch open
6	4	44	System high pressure protection: Overcharged, high condensing temperature or malfunction of fan motor
6	5	45	System low pressure protection: Undercharged, low defrosting temperature, or malfunction of fan motor
6	6	/	Incorrect match between indoor & outdoor
0	1	/	Indoor ambient temperature sensor failure
0	2	/	Indoor coil temperature sensor failure
0	4	/	Indoor PCB EEPROM failure
0	7	/	Communication fault between the indoor and outdoor unit
0	8	/	Communication fault between the controller and Indoor unit
0	12	/	Drain system malfunction
0	13	/	Zero cross signal detected wrong
0	14	/	Indoor fan motor malfunction



USYM09UCDSA
USYM12UCDSA
USYM18UCDSA
USYM24UCDSA

Table of Contents

Components..... 39

 Component Overview 39

 Indoor Unit Circuit Board..... 41

 Fresh Air Function..... 42

Ductwork/Grilles..... 43

Testing..... 44

 Test Condensate Pump and Associated Float Switch 44

 Testing Temperature Sensors 44

 Testing Communication Circuit 45

 Indoor Fan Motor Voltage Check 45

 Static Pressure Charts..... 46

 Board Replacement 47

 Removing the Condensate Pump 47

 Removing Fan Motor 47

 Replacing WiFi Module..... 48

Wiring Diagram..... 49

DIP Switch Settings..... 50

Error Codes..... 55

Components

The Mid-Static Ducted Indoor Unit will act as evaporator coils during cooling mode and condenser coils during heating mode. This unit can operate with a motorized supply air louver or it can have a LIMITED amount of ducting added to the unit's return and supply air duct connection flanges. The return air ducting can be connected to the end of the cabinet or the bottom blank off plate can be removed for bottom return configuration.

DIP Switches on the unit's circuit board configure the fan power to match the ducting configuration.

These units have a built in condensate pump with an associated condensate level switch. The condensate pump is capable of lifting water out of the indoor unit. If high water lift is needed, the water from the cassette pump should be pumped into a field supplied condensate pump with high lift power.

The layout of the system is very straightforward and components are easily accessed should service be required. The blower assembly and room air temperature sensor is accessed at the rear of the evaporator coil, and the piping temperature sensor is located under the top cover. The condensate pump and float switch are accessed under the removable panel next to the electrical control box.

The wired controller can be configured to sense room air temperature. There is no option for use with remote control.

All operating status and information is displayed on the wired controller. The Mid-Static Ducted unit does not have a display.

Component Overview

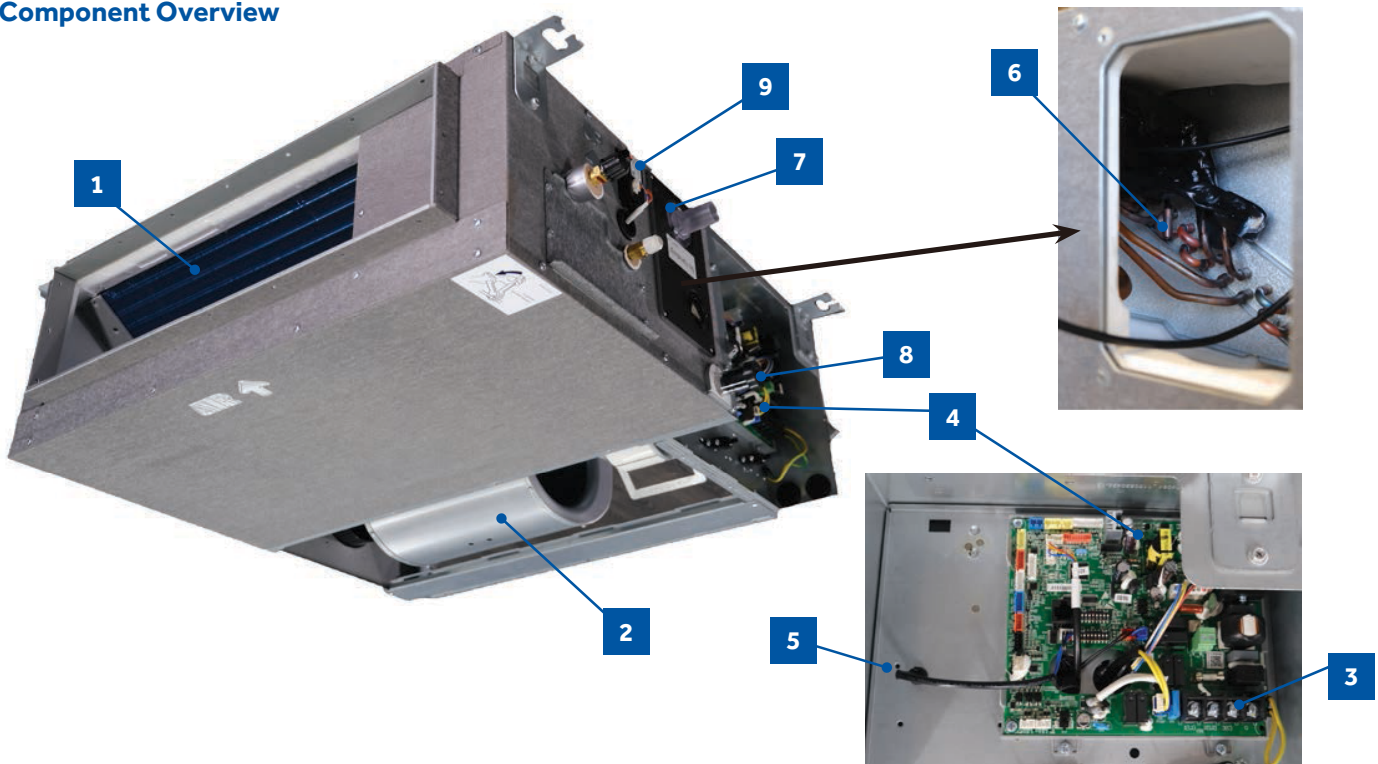

1 Evaporator Coil

2 Blower Assembly

The indoor unit features a DC variable speed dual shaft blower motor that will change speed to match the capacity demand from the outdoor unit. The motor is a dual shaft type that powers two individual blower assemblies.

The blower assembly consists of 2 plastic blowers. A set screw holds each blower wheel to the blower motor.

The indoor blower motor is connected to the indoor unit control board. The wiring from the motor to indoor board consists of 5 wires connected to pins that deliver line voltage, speed, and feedback information.

During normal operation, the indoor control board will energize the indoor blower motor and request proper speed. Fan power should be set using the DIP Switches SW1 settings.

3 Terminal Block

Power to operate the indoor unit comes from the electrical line voltage terminal block at the outdoor unit. The wiring includes 4 wires, 1, 2, 3 and ground. Wires 1 and 3 complete the data path. These wires should always be 14 gauge AWG Stranded type wire. Splices in wires 1 or 3 may cause communication errors.

4 Control Board

Located under the electrical control box cover.

5 Ambient Temperature Sensor

The Ambient Temperature Sensor senses room temperature. This sensor provides room temperature information to the ECU for calculation of inverter capacity and temperature control.

6 Piping Temperature Sensor

The Piping Temperature Sensor senses indoor coil temperature in the cooling mode and in the heating mode. This sensor is used for Anti Freezing and Anti Cold Blow cycles. The sensor also provides critical temperature information to the ECU that may be used in frequency adjustments.

7 Condensate Pump

The Mid-Static Ducted unit has a built in condensate pump. The pump is connected to the circuit board. The pump is energized whenever the Float Switch indicates that water needs to be pumped from the cassette. The float switch connects onto the circuit board.

The float switch and pump are located behind the removable insulated cover next to the electrical control box. The pump is hermetically sealed and requires no maintenance. The float switch is a normally closed switch, that opens as water rises. The float switch requires no maintenance.

1. If in COOL or DRY mode: Compressor running (Thermal ON), then condensate pump is energized
 - When compressor stops (Thermal OFF), condensate pump runs for an additional 5 minutes
2. If in COOL or DRY modes and compressor is running (Thermal ON) and the float switch opens for 5 minutes
 - Compressor will stop, the pump will continue to run
 - If the float switch does not close, error code will display and pump continues to run
 - If the float switch does close, the pump will continue to run for 5 additional minutes
3. During standby (Thermal OFF) in COOL/DRY modes or in HEAT and FAN modes and float switch opens for 2 seconds, the condensate pump is energized.
 - If the float switch closes, the pump will run an additional 5 minutes
 - If the float does not close, the pump continues to run and error code is displayed

8 Gravity Drain Ports

The indoor unit has the option for either gravity drain systems or the use of an internal condensate pump with float switch. The pump is capable of minimal lift. If high lift is required, the water from the Mid-Static Ducted unit should be pumped to field supplied condensate pump that is capable of high lift.

9 WiFi

The unit comes shipped with a WiFi module that provides control via a smartphone app.

Components

Indoor Unit Circuit Board

The indoor unit circuit board controls the switching functions of the indoor unit. All control decisions are made by the outdoor unit ECU. The indoor board has some limited diagnostic capability which will be covered in this manual.

- 1 CN17-GEA3 wifi module socket
- 2 CN6-DC fan motor socket
- 3 CN10-Fresh air link/E.A.O socket
- 4 CN-4-Frelay for auxiliary heater link (Dry contact,rating-230VAC ,3A)
- 5 CN1- Power terminal block
- 6 CN19-Float switch socket
- 7 CN3-Temperature sensor socket (Tr:ROOM SENSOR, Tp:PIPE SENSOR)
- 8 CN22-1-Wired controller socket2
- 9 CN22-Wired controller socket1

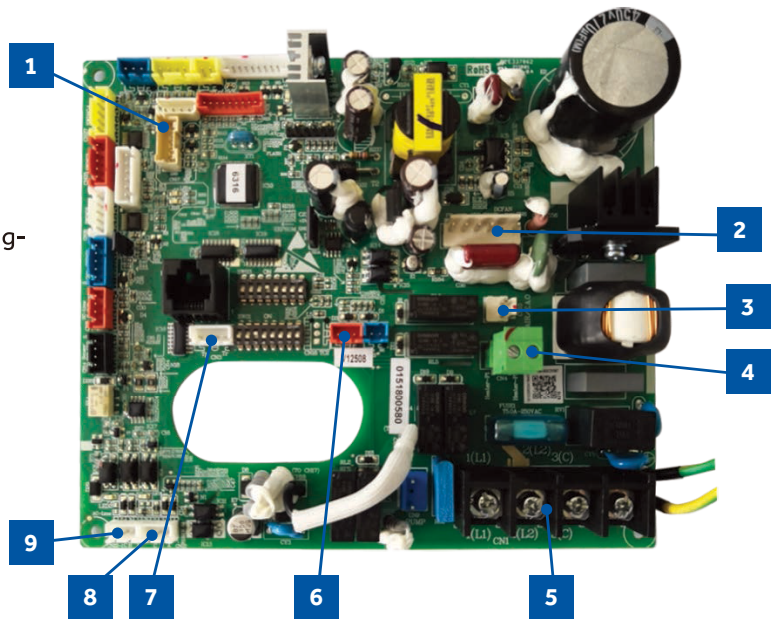

The Indoor Unit Circuit Board communicates with the outdoor unit ECU via a connection at Terminal Block screw 3. The data pulse that sends the communication information can be measured with a voltmeter placed to DCV range. From the ground connection at the Terminal Block to the Number 3 screw connection, the voltage should pulse up and down when data is being transmitted.

Line voltage to power the indoor unit comes in on Terminal Block connections 1 and 2. Power connects from these terminal connections to CH- 1 and CH-2 on the circuit board. If the board does not respond to commands and has no display, check for line voltage at these connections. When power is present at the indoor board, the wired controller will be energized.

The connections on the indoor board are shown here in the schematic drawing.

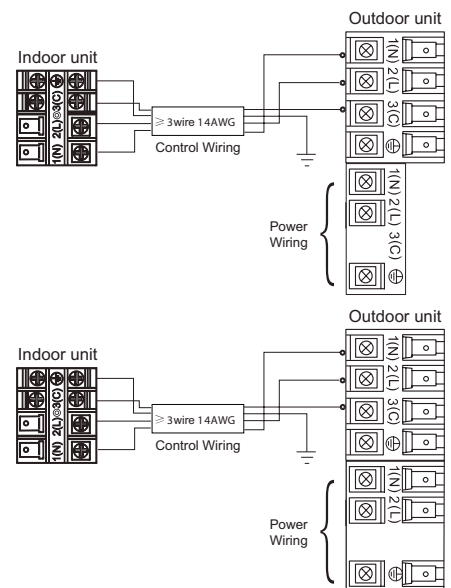

This control board has control over the fan louver movement, manual fan blower control, indoor coil temperature and indoor air temperature sensing functions. All operational decisions are controlled by the OUTDOOR UNIT ECU.

The control board has a replaceable 5A 250V fuse that protects against excessive current. If power is present at the board but the board does not work, check for continuity through the fuse. Replace if the fuse is open.

The indoor unit temperature sensors are connected at Plug CN-13. When testing the calibration of these sensors, the wires can be released from the plug by pressing on the tension tab on the side of the plug.

There 3 motors that control the directional movement of the accessory louver. The motor connects to the circuit board at Plug CN-14, CN-15 and CN-16. The motors are located in the louver assembly.

The blower motor is connected to the circuit board at plug CN-6.

Fresh Air Function

When there is fresh air signal received by the Indoor Unit PCB (the fresh air signal can be sent by infrared remote controller or wired controller), the Normal fresh air function is valid.

When a call for Fresh Air is received, via the wireless or wired controller, the unit will enable the standard fresh air function.

This function can be activated at any mode except defrost mode. When the IDU been turned off by controller, the fresh air function is invalid. This function can be activated in any mode, except for defrost mode. When the Indoor Unit has been turned off via the controller, the fresh air function will be disabled.

Call for Fresh Air is Received:

In Cooling / Dehumidification mode:

The fresh air output will maintain a 20 minutes ON, 20 minutes OFF cycle after the compressor starts.

This cycle will be active until one of the following occurs:

- Fresh air function is canceled via the controller (wired controller or wireless remote controller)
- Indoor unit has been via the controller
- The compressor stops.

In Fan Only mode:

The fresh air output will maintain a 20 minutes ON, 20 minutes OFF cycle

This cycle will be active until one of the following occurs:

- Fresh air function is canceled via the controller (wired controller or wireless remote controller)
- Indoor unit has been via the controller

In Heating mode

The fresh air output will maintain a 20 minutes ON, 20 minutes OFF cycle after the compressor starts.

This cycle will be active until one of the following occurs:

- Fresh air function is canceled via the controller (wired controller or wireless remote controller)
- Indoor unit has been via the controller
- The compressor stops.
- The system enters into Defrost Cycle.

Special Fresh Air Function (Canadian Ventilation Mode - Mid Static Ducted Only)

Special fresh air function (Canadian ventilation mode) is valid when DIP switch SW3_1 is set to the ON position, and invalid when DIP switch SW3_1 is set to OFF position.

When this function is enabled and the Indoor Unit is ON, the the unit will proceed Continuous Fresh Air, keeping the Indoor Fan Motor energized even if the compressor is stopped or the IDU reaches it's real setpoint temperature (real setpoint=customer set point + compensation point).

Notes:

- *During an active Call, the fan motor speed will be whatever setting the customer has set it to. Once the Call is satisfied, the fan motor speed will be set to a special Low setting that corresponds to the ESP setting.*
- *During a Defrost Cycle, the indoor fan is disabled, along with the Fresh Air Function*

Basic Duct Configurations

Here are the typical duct configurations that can be used with the unit.

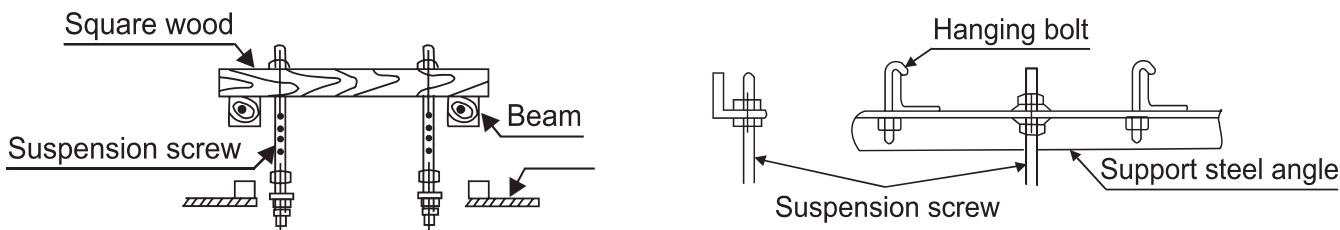

Ductwork Installation

Roof Installation

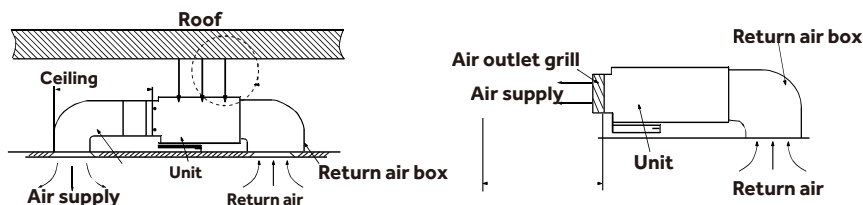

Long Duct

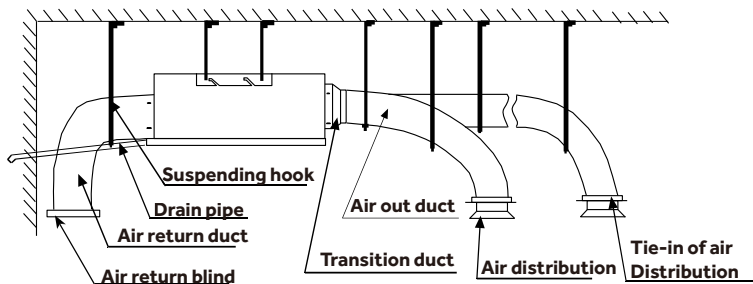

Use rivet to connect the air return duct on the air return inlet of the indoor unit, then connect the other end with the air return

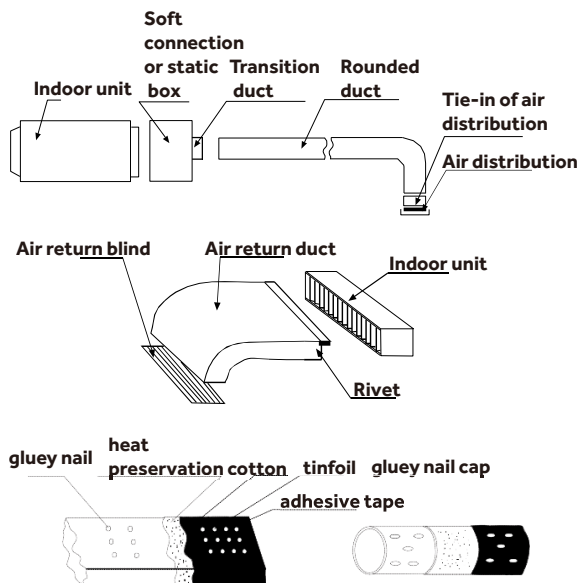

Test Condensate Pump and Associated Float Switch

If the internal condensate pump does not operate, the pump may be bad or the float switch may be defective. Perform the following test:

1. Access the electrical control box.
2. Unplug the float switch from the circuit board.

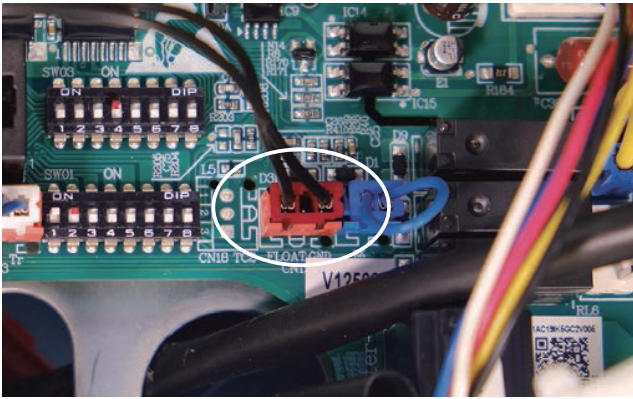

3. The pump should start.
4. If the pump does not start, check for voltage at the pump control board connection. There should be 230 Volts AC to the pump. If there is not, the circuit board is defective. If there is proper voltage to the pump, either the pump or associated pump wiring is defective.

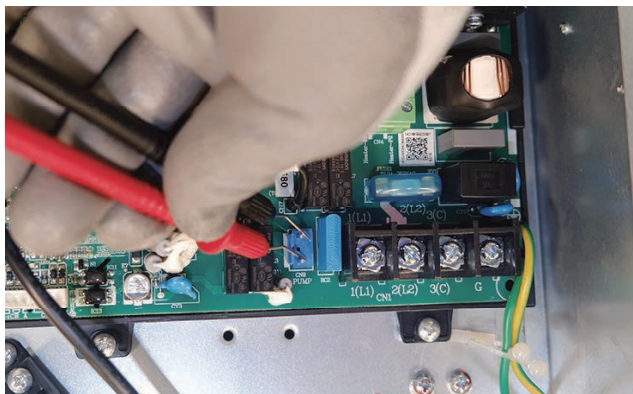

5. When installing, the condensate discharge port at the top of the water pump must be connected with drain pipe.

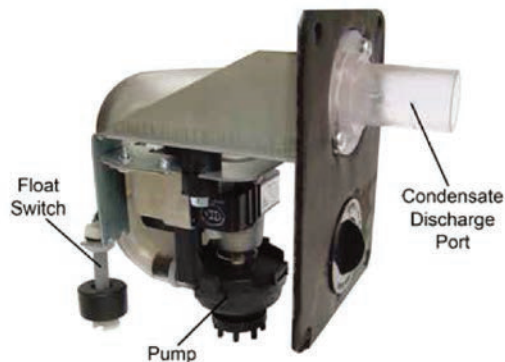

Testing Temperature Sensors

The easiest problems to solve will involve codes that are related to potential failure of temperature sensors. Common problems may include loose connections, open electrically, and out of calibration. Checking the condition of the sensors requires a temperature probe and an ohmmeter.

The Reference Section of this manual contains temperature resistance tables that can be used to check the calibration of the sensors. The measured resistance must be within the tolerances printed on the top of the tables.

1. Confirm the sensor is firmly attached to the circuit board connection plug.
2. Remove the sensor wires from the connection plug by releasing holding tension on the plugs tension tab.

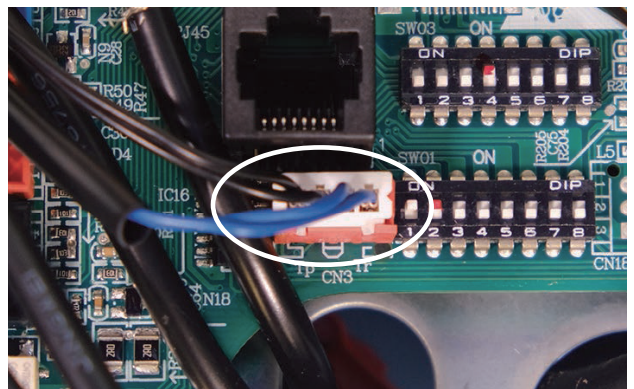

3. Use an ohmmeter to test the electrical resistance of the sensor.

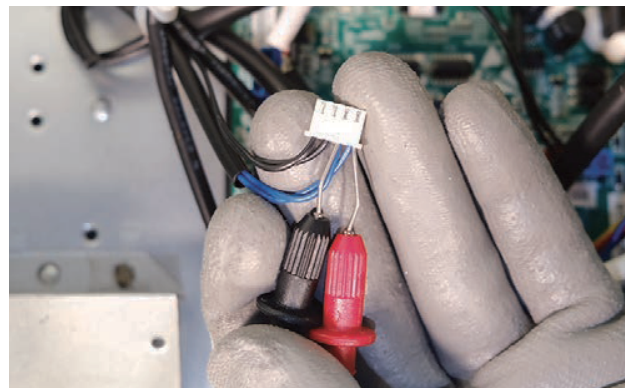

4. Measure the air temperature near the sensor and compare the required resistance against measured resistance. (refer to charts in reference section) If the sensor is within calibration, the sensor is good. If the sensor is out of calibration, replace the sensor. (Tube Sensors should be removed from socket and exposed to air temperature during test.)

Testing

Testing Communication Circuit

If an Error E7 occurs, perform the following test to determine if the indoor control board is functioning properly to send data to the outdoor unit.

Perform this test with the unit powered and all wiring connected between indoor and outdoor unit.

Make sure all wiring between the indoor and outdoor unit are correct. There should be no splices between the indoor and outdoor unit wiring connecting terminals 1 or 3. Make sure wiring is correct, before performing this test.

1. Measure the DC voltage between terminals 1 and 3 on the indoor terminal block.

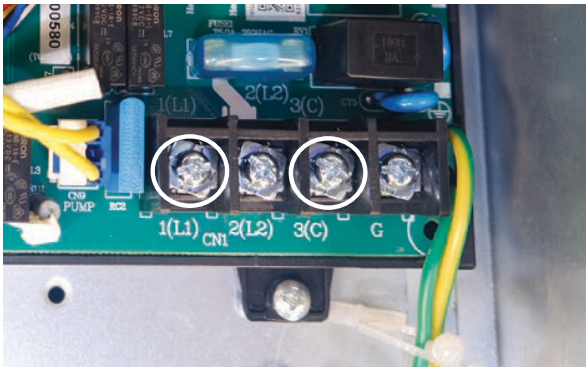

2. The voltage should fluctuate between 8VDC and 23VDC. The fluctuating signal indicates a good communication path.
3. If the voltage does not fluctuate, and the wiring is good, the indoor board is defective.

Indoor Fan Motor Voltage Check

If The Indoor Fan Motor Does Not Run:

1. Remove the front cover and access the fan motor circuit board connection.
2. Reset power and turn the remote control fan command to Fan On mode.

Motor Test:

1. If the motor doesn't run, check for 310VDC between Pins 1 and 3. If it is not present, the indoor board is bad. If voltage is present, continue on.
2. Check the voltage between Pins 3 and 4. The voltage should be +15VDC. If it is not present, the board is bad. If voltage is present, continue on.
3. Check for voltage between Pins 3 and 6. If no DC voltage is present, the board is bad. If voltage is present, change the motor.

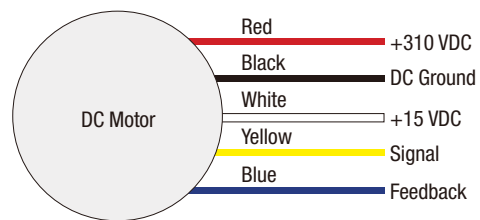
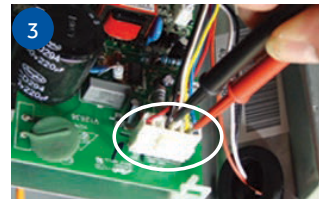
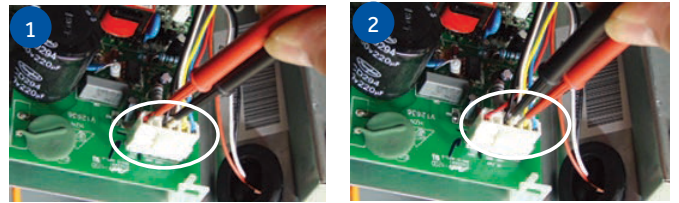

Static Pressure Charts

USYM09UCDSA

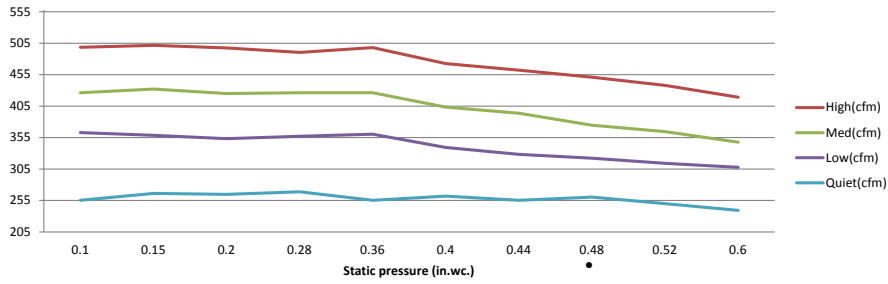

USYM12UCDSA

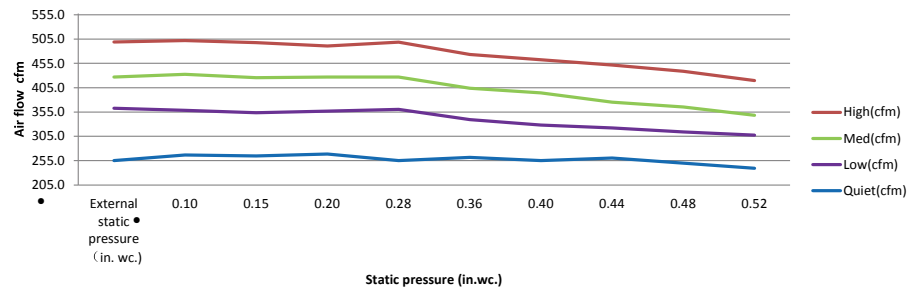

USYM18UCDSA

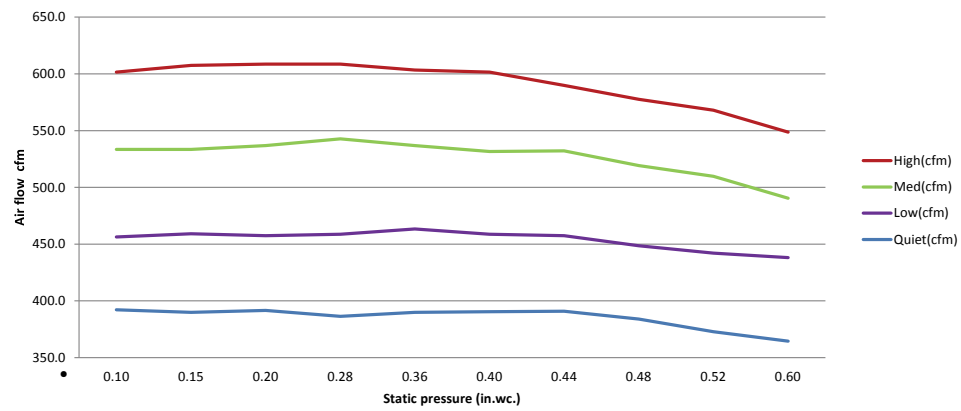

USYM24UCDSA

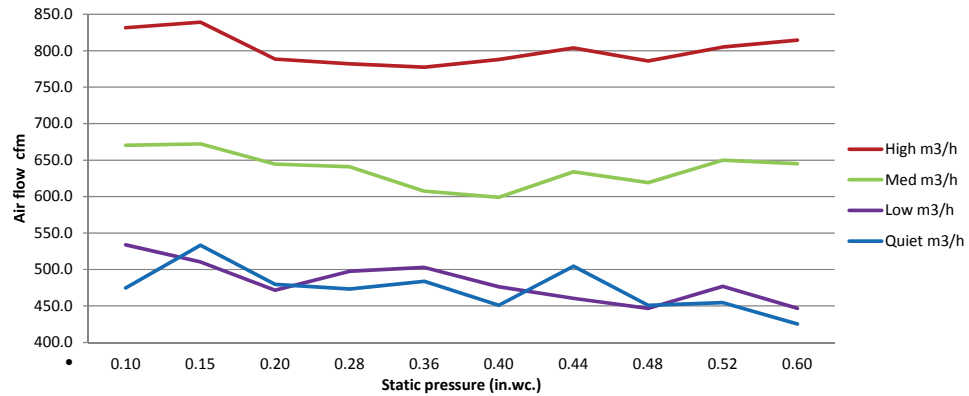

Testing

Board Replacement

1. Remove the ambient sensor.



2. Unplug all connectors from the board.
3. Remove the 2 board mounting screws and remove the board.

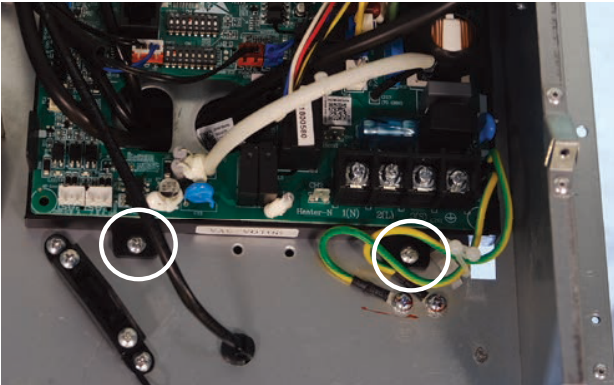

Removing the Condensate Pump

1. Remove the air inlet cover.

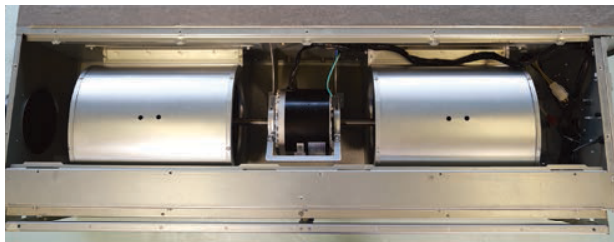

2. Unplug the pump motor and float switch wires from within the air inlet



3. Remove the 4 screws holding the pump in place.

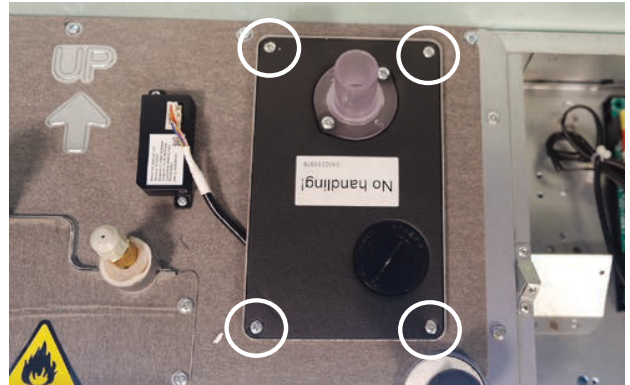

4. Tilt the pump out from the top and pull out

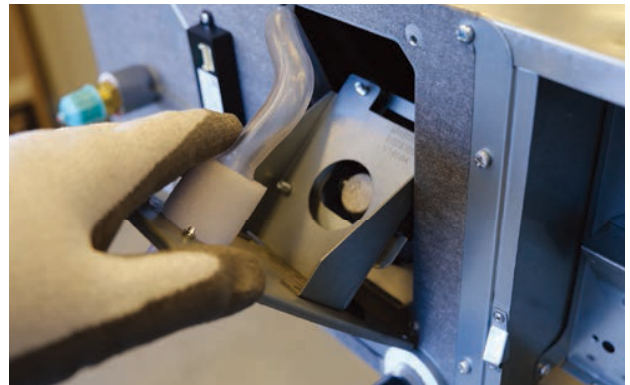

5. Pull wires through rubber grommets and remove pump assembly

Removing Fan Motor

1. Remove control board cover.
2. Unplug motor wires.



Testing

3. Feed motor wires into the air inlet box
4. Remove the air box cover.

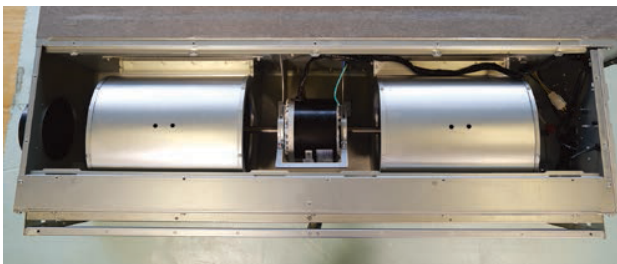

5. Remove the corner bracket.

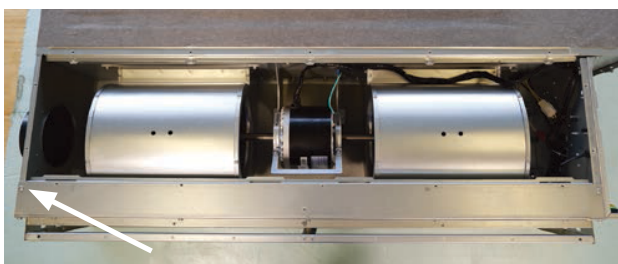

6. Remove the ground screw and free the motor wire harness.

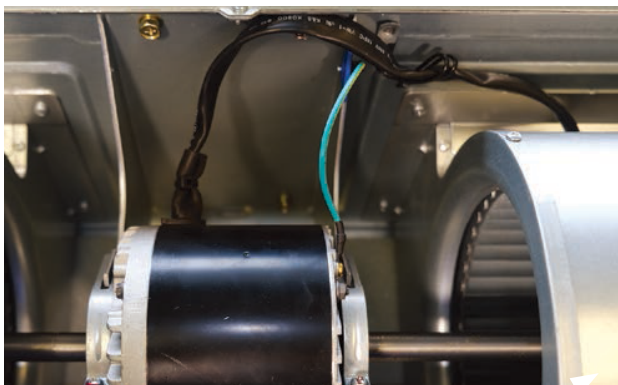

7. Remove the screws holding the blower housing to the unit, 4 on each housing.

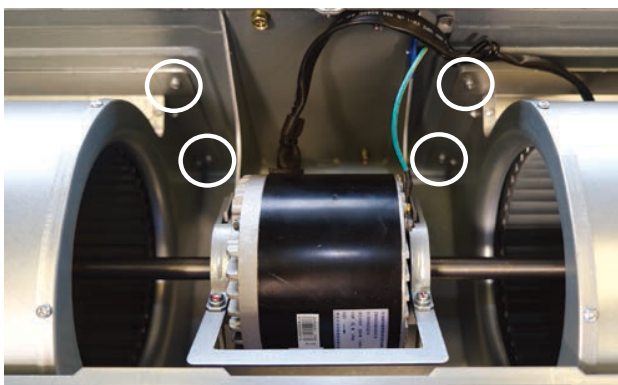

8. Support the motor (2 people may be required at this time). Loosen the 2 screws of the motor mount bracket and remove full assembly
9. Using a long 4mm hex wrench, loosen the set screws from the blower wheel and remove from motor shaft.

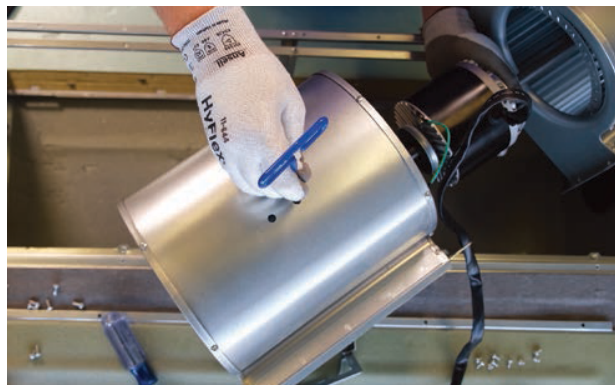

Replacing WiFi Module

1. Unplug existing WiFi module.

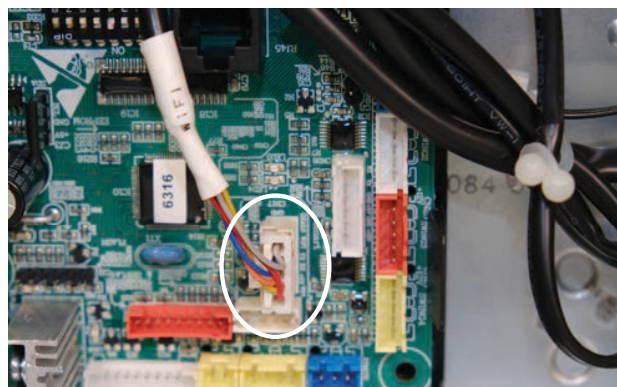

2. Insert new WiFi module.
3. Replace the wifi passcode sticker.
4. Pair the unit to account.

Wiring Diagram

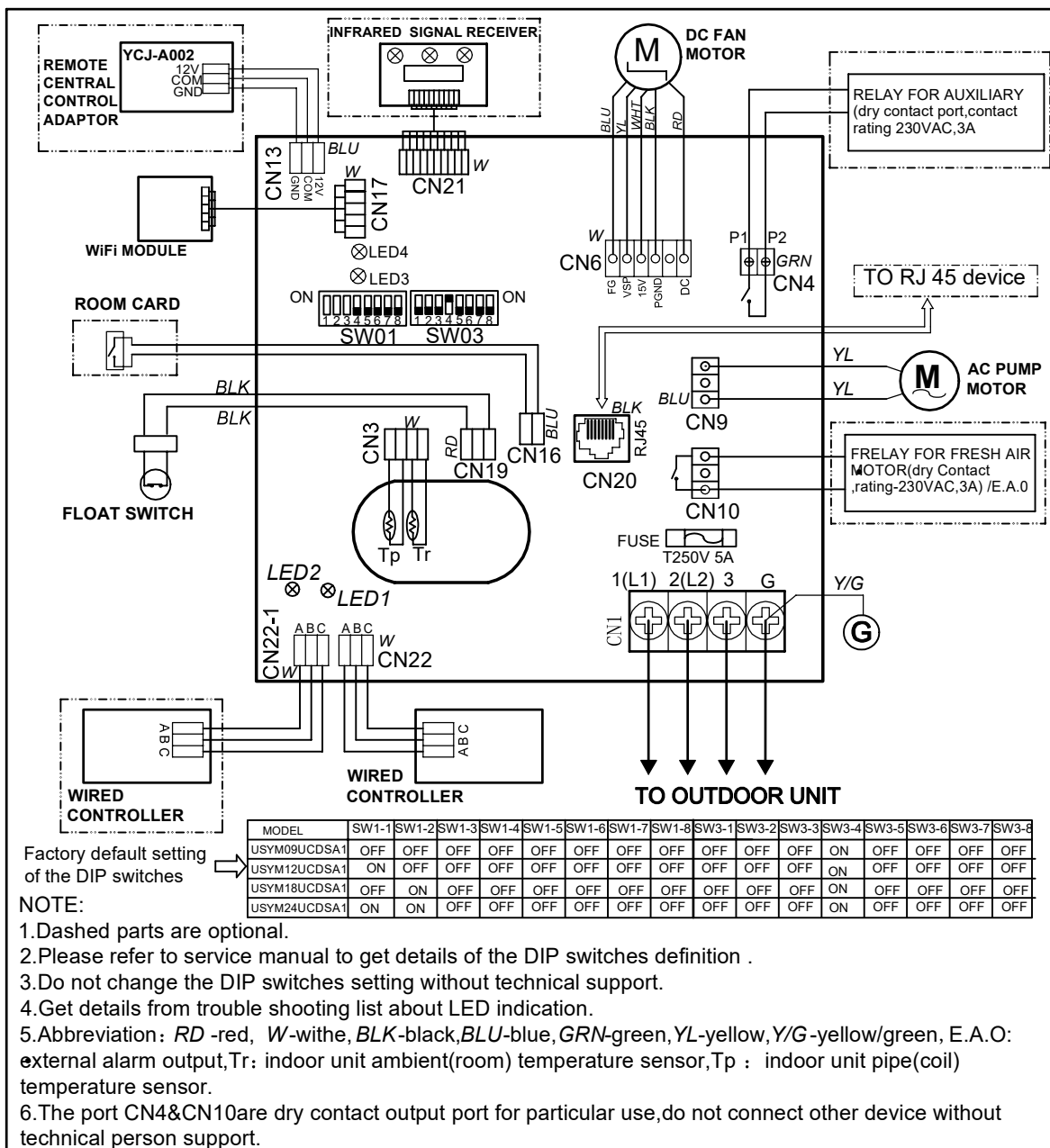

0151539442

DIP Switch Settings

SW1 DIP Switch Settings

Description	SW1-1	SW1-2	SW1-3	SW1-4	SW1-5	SW1-6	SW1-7	SW1-8
Capacity: 9000btu/h	OFF	OFF	OFF	---	---	---	---	---
Capacity: 12000btu/h	ON	OFF	OFF	---	---	---	---	---
Capacity: 18000btu/h	OFF	ON	OFF	---	---	---	---	---
Capacity: 24000btu/h	ON	ON	OFF	---	---	---	---	---
Room card invalid	---	---	---	OFF*	---	---	---	---
Room card valid	---	---	---	ON	---	---	---	---
Heat pump	---	---	---	---	OFF*	---	---	---
Cooling only	---	---	---	---	ON	---	---	---
Fresh air valid	---	---	---	---	---	OFF*	---	---
External alarm output	---	---	---	---	---	ON	---	---
Without filter clean warning	---	---	---	---	---	---	OFF*	---
With filter clean warning	---	---	---	---	---	---	ON	---
North America area	---	---	---	---	---	---	---	OFF*
Non-North America area	---	---	---	---	---	---	---	ON

*Factory Default Setting

SW3 DIP Switch Settings

Description	SW3-1	SW3-2	SW3-3	SW3-4
Special fresh air (Canadian ventilation mode, Canada particular Area) invalid	OFF*	---	---	---
Special fresh air (Canadian ventilation mode, Canada particular Area) valid	ON	---	---	---
Console/MESP Duct	---	OFF*	---	---
Cassette (Reserved)	---	ON	---	---
Auxiliary heater invalid	---	---	OFF*	---
Auxiliary heater valid	---	---	ON	---
ESP grade 0-4 level	---	---	---	OFF
ESP grade 0-10 level	---	---	---	ON*

*Factory Default Setting

Error Codes

The error codes that are displayed on the indoor units may vary from the outdoor unit codes. The information communicated by the error code will be the SAME for both indoor and outdoor units even though the numbers may differ.

Indoor LED4	Indoor LED3	Outdoor LED	Diagnosis
2	1	1	Outdoor EEPROM failure
2	2	2	IPM overcurrent or short circuit
2	3	/	Compressor over current during deceleration
2	4	4	Communication failure between the IPM and outdoor PCB
2	5	5	Module operated overload (compressor overload protection)
2	6	6	Module low or high voltage
2	7	/	Compressor current sampling circuit fault
2	8	8	Overheat protection for discharge temperature
2	9	9	Malfunction of the DC fan motor
3	0	10	Malfunction of defrost temperature sensor
3	1	11	Suction temperature sensor failure
3	2	12	Ambient temperature sensor failure
3	3	13	Discharge temperature sensor failure
3	4	/	PFC circuit loop voltage
3	5	15	Communication failure between the indoor & outdoor unit
3	6	16	Lack of refrigerant or discharging
3	7	17	4-way valve switching failure
3	8	18	Loss of synchronism detection
3	9	/	Low DC or AC voltage
4	0	20	Indoor thermal overload
4	1	21	Indoor coil frosted
4	2	/	PFC circuit loop overcurrent
4	3	23	Module thermal overload
4	4	24	Compressor start failure, over-current
4	5	25	Phase current protection (IPM)
4	6	26	MCU reset
4	7	27	Module current detect circuit malfunction
4	8	28	Liquid pipe sensor failure: Circuit A
4	9	29	Liquid pipe sensor failure: Circuit B
5	0	30	Liquid pipe sensor failure: Circuit C
5	1	31	Liquid pipe sensor failure: Circuit D
5	2	32	Gas pipe sensor failure: Circuit A
5	3	33	Gas pipe sensor failure: Circuit B
5	4	34	Gas pipe sensor failure: Circuit C
5	5	35	Gas pipe sensor failure: Circuit D
5	6	36	Gas pipe sensor failure: Circuit E
5	7	/	Compressor overcurrent detected by IPM
5	8	38	Malfunction of module temperature sensor momentary power failure detection
5	9	39	Malfunction of condensing temperature sensor
6	0	40	Liquid pipe sensor failure: Circuit E
6	1	41	Toci temperature sensor failure
6	2	42	High Pressure switch open
6	3	43	Low Pressure switch open
6	4	44	System high pressure protection: Overcharged, high condensing temperature or malfunction of fan motor
6	5	45	System low pressure protection: Undercharged, low defrosting temperature, or malfunction of fan motor
0	1	/	Indoor ambient temperature sensor failure
0	2	/	Indoor coil temperature sensor failure
0	4	/	Indoor PCB EEPROM failure
0	7	/	Communication fault between the indoor and outdoor unit
0	8	/	Communication fault between the controller and Indoor unit
0	12	/	Drain system malfunction
0	13	/	Zero cross signal detected wrong
0	14	/	Indoor fan motor malfunction



USYF09UCDWA
 USYF12UCDWA
 USYF18UCDWA

Table of Contents

Components..... 53
 Component Overview 53
 Indoor Circuit Board..... 54
 Testing..... 55
 Removing the Filter Cover & Filter 55
 Front Cover Removal..... 55
 Control Box Removal 55
 Board Replacement 55
 Upper Louver Removal..... 56
 Lower Damper Assembly Removal..... 56
 Replace Fan Motor 56
 Indoor Fan Motor Test Procedure 57
 Testing Temperature Sensors 58
 Testing Louver Motors 58
 Testing Communication Circuit 59
 Replacing WiFi Module..... 59
 Wiring Diagram/DIP Switch Settings..... 60
 Error Codes..... 61

Components

The indoor console unit functions as an evaporator coil during cooling mode, and as a condensing coil during heat mode. Condensate is collected by a drain pan below the coil and condensate is drained directly to the outdoor or to a secondary condensate pump via the provided condensate drain line

Console units may be operated with either a wired remote control or the wireless remote control provided with the unit.

Component Overview

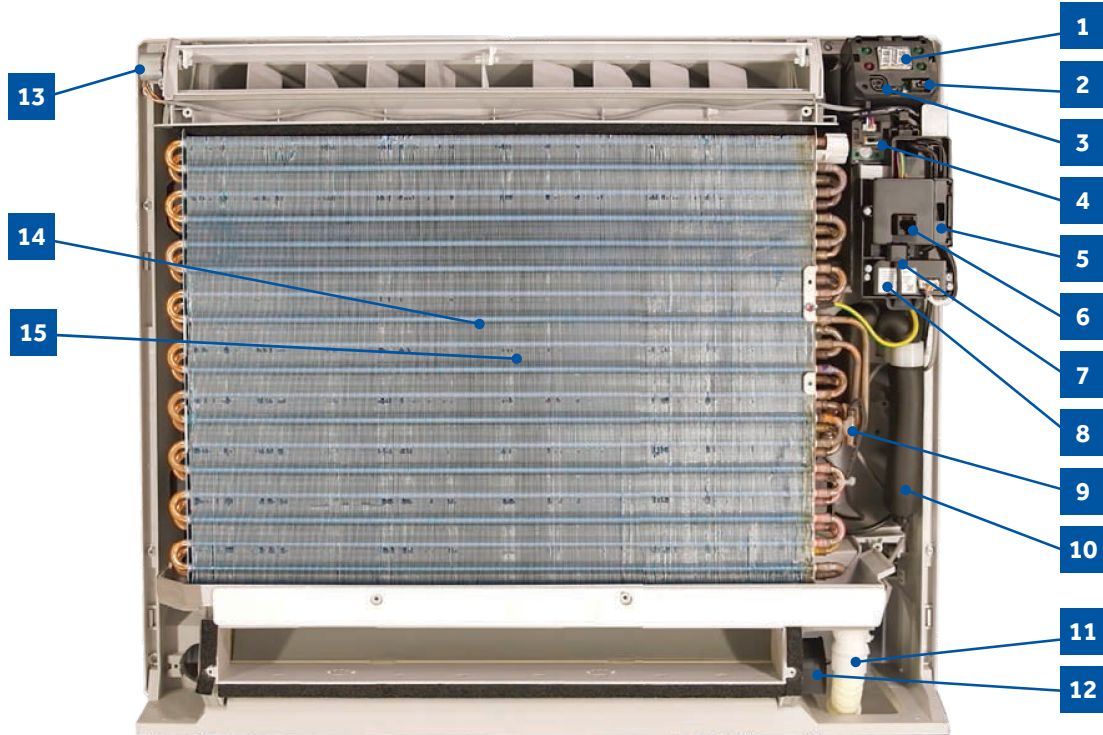

1 Display

The indoor unit display communicates system mode, but does not display temperatures or diagnostic codes. This information is indicated on the wired or wireless control.

When servicing a diagnostic error always refer to the outdoor unit code.

2 IR Receiver

3 Power Switch

4 Lower Damper Control

5 Control Board Box

6 Diagnostic Port

7 Ambient Sensor

The Ambient Temperature Sensor senses room temperature. This sensor provides room temperature information to the ECU for calculation of inverter capacity and temperature control.

8 WiFi Module

9 Coil Sensor

The Coil Temperature Sensor senses indoor coil temperature in the cooling mode and in the heating mode. This sensor is used for Anti Freezing and Anti Cold Blow cycles. The sensor also provides critical temperature information to the ECU that may be used in frequency adjustments.

10 Flare Connections

11 Condensate Drain

12 Lower Damper Motor

13 Upper Louver Motor

The louver motor is a stepper type motor that moves the louver left/right. The motor is controlled by a pulsed voltage that cannot be measured. If the louver does not move when it should, check for a bind in the louvers.

14 Blower Fan (behind coil)

15 Blower Motor (behind coil)

The indoor unit features a multi-speed blower motor that will change speed to match the capacity demand from the outdoor unit. The blower motor is controlled by both the remote control and by commands from the outdoor unit ECU

Components

Indoor Circuit Board

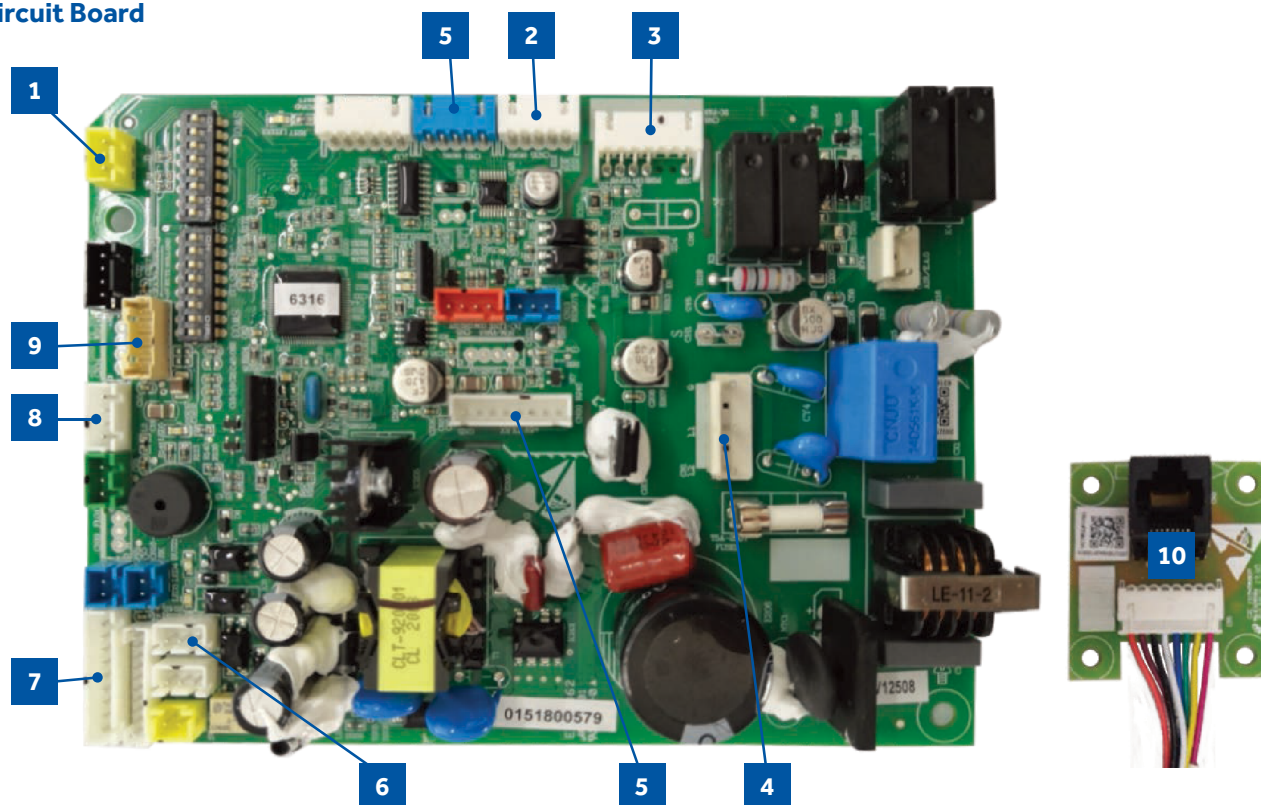

- | | |
|--|--|
| 1 SW2-Damper switch | 7 CN31- Display |
| 2 CN35- Lower damper motor | 8 CN3-Temperature sensor socket (Tr: ROOM SENSOR, Tp:PIPE SENSOR) |
| 3 CN6-DC fan motor | 9 CN17-WiFi module |
| 4 Power supply | 10 RJ45 adapter board |
| 5 CN20-Diagnostic port | |
| 6 CN22- Optional wired controller | |

The indoor unit circuit board controls the switching functions of the indoor unit. All control decisions are made by the outdoor unit ECU. The indoor board has some limited diagnostic capability which will be covered in this manual.

The indoor unit Circuit Board communicates with the outdoor unit ECU via a connection at terminal block screw 3. The data pulse that sends the communication information can be measured with a voltmeter set to DC voltage range. From the ground connection at the terminal block to the number 3 screw, voltage should pulse up and down when data is transmitted.

Line voltage to power the indoor unit is made on terminal block connections 1 and 2. Power connects from these terminal connections to CH-3 and CH-4 on the circuit board. If the board does not respond to command and has no display, check for line voltage at these connections. When power is present at the indoor board, the Display Power Indicator will be lit. The control board has a replaceable 3.15A 250V fuse that protects against excessive current. If power is present at the board but the board does not work, check for continuity through the fuse. Replace if the fuse is open.

The indoor unit sensors are connected at plug CN-13. When testing the calibration of these sensors the wires can be released from the plug by pressing the tension tab on the side of the plug.

The receiver/display unit, mounted on the front cover of the indoor unit plugs connects to the circuit board at location CN-29.

The blower/fan motor connection is located at plug CN-11.

Removing the Filter Cover & Filter

1. Slide the side latches up to unlock the cover and pull forward about an inch then lift up.



2. The filter is very flexible and can be grabbed at any location and removed.

Front Cover Removal

1. Remove the 4 screws that are at the corners of the air intake opening. Gently open the horizontal louver. Lift up the top edge of the front cover and then pull forward.

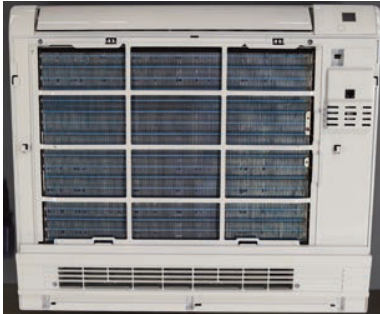

Control Box Removal

1. Remove the screw from the right side of the box cover.



2. Lift up the panel that contains the diagnostic port, wifi module and ambient sensor. And remove the box cover.

3. Unplug the three connectors for the fan motor, upper louver and bottom damper.

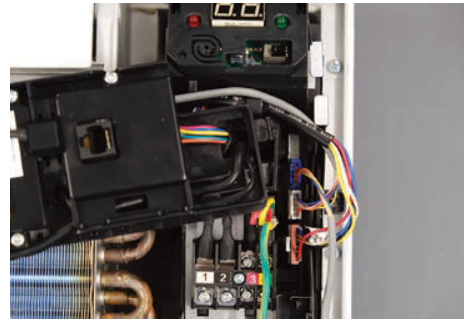

4. Remove the ground screw.

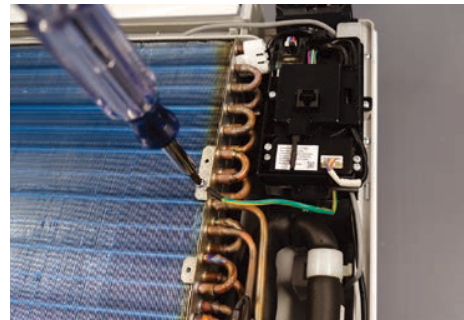

5. Remove the mounting screw for the box.



6. The box can now be removed.

Board Replacement

1. Follow the instructions for removing the control box.
2. Remove the cover screw from the bottom of the box, then remove cover.



Testing

3. Take note of connection location and carefully remove each connector.
4. Remove the 2 screws mounting the board in the box. They in diagonal corners from each other.

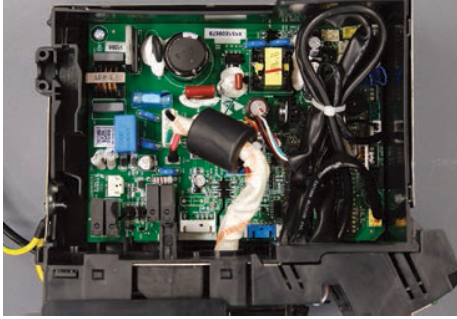

Upper Louver Removal

1. Remove the filter cover and front cover.
2. Locate and remove the two screws mounting the upper louver assembly to the case. They are on either end of the assembly.

Lower Damper Assembly Removal

1. Remove the filter cover and front cover.
2. Disconnect the condensate drain.
3. Locate and remove the two screws mounting the damper assembly to the case.
4. Pull on the right end of the assembly and rotate the bottom of the assembly outward.

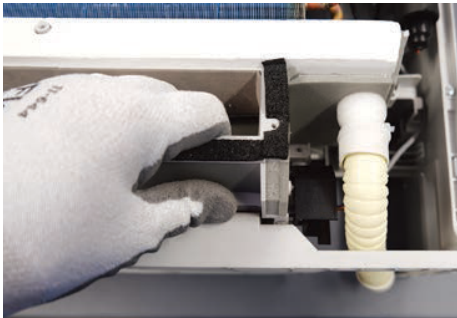

Note: When re-installing the damper assembly, first place the front edge of the condensate drain pan into place then rotate the bottom of the assembly into position.

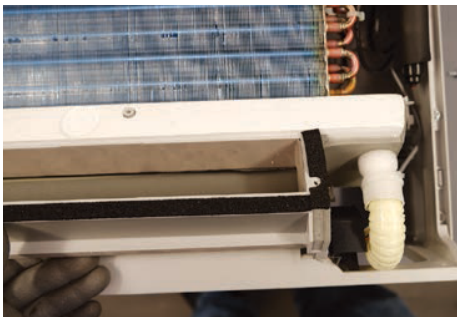

Replace Fan Motor

1. Remove filter cover, front panel, control box, upper louver and bottom damper.
2. Remove the white plastic strap that hold the line set in place on the right side of the unit.

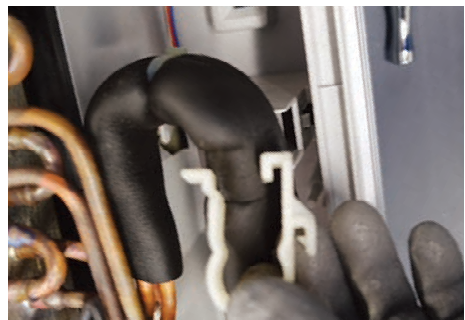

3. Locate the locking tabs on the left side of the evaporator and press them inward and pull the coil forward to remove.



IMPORTANT: Great care should be taken to when performing this step. Excessively moving the lineset that connects to the flare can cause a refrigerant leak.

4. Slide the coil to the right to. The coil can now be gently pulled away from the case. Only move the coil far enough to access the four screws holding on the fan inlet faring.

Testing

5. Remove the four screws holding on the fan inlet faring.

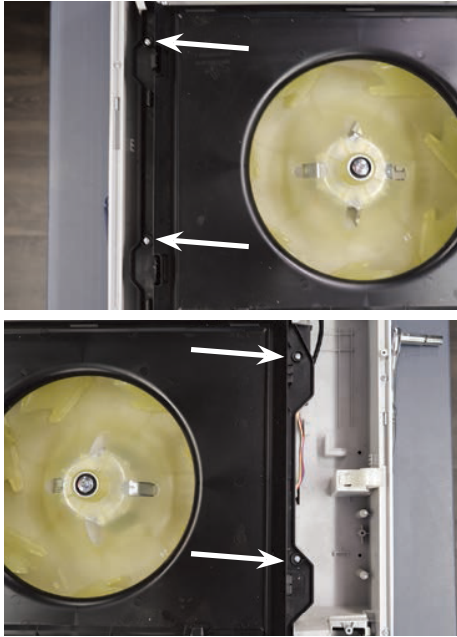

6. Remove the wire cover from the back of the case.



7. Remove the motor bracket.

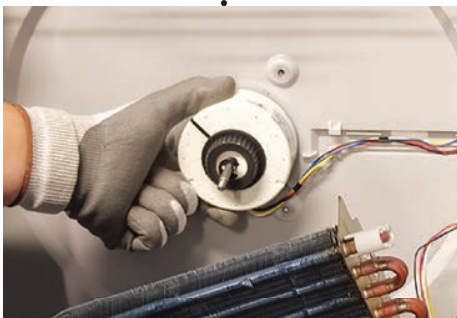

NOTE: when replacing the motor, the wires must exit from the bottom of the motor to prevent water from entering the motor.

Indoor Fan Motor Test Procedure

If the indoor fan motor does not run:

1. Disconnect power to the system.
2. Remove the return air cover and access the fan motor circuit board connection.
3. Reset power and turn the remote control fan command to Fan On mode.

Motor Test:

1. If the motor doesn't run, check for 310VDC between Pins 1 and 3. If it is not present, the indoor board is bad. If voltage is present, continue on.
2. Check the voltage between Pins 3 and 4. The voltage should be +15VDC. If it is not present, the board is bad. If voltage is present, continue on.
3. Check for voltage between Pins 3 and 6. If no DC voltage is present, the board is bad. If voltage is present, change the motor.

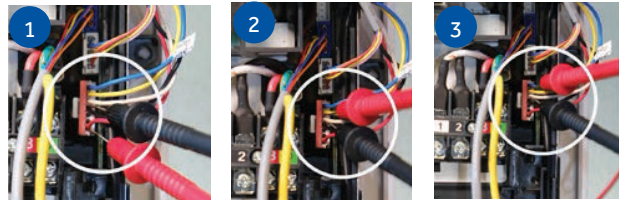
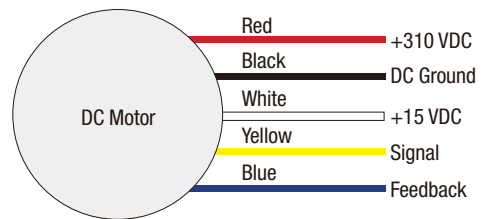

Testing Temperature Sensors

The easiest problems to solve will involve codes that are related to potential failure of temperature sensors. Common problems may include loose connections, open electrically, and out of calibration. Checking the condition of the sensors requires a temperature probe and an ohmmeter.

The Reference Section of this manual contains temperature resistance tables that can be used to check the calibration of the sensors. The measured resistance must be within the tolerances printed on the top of the tables.

To test the electrical condition of a temperature sensor perform the following:

1. Confirm the sensor is firmly attached to the circuit board connection plug.
2. Remove the sensor wires from the connection plug by releasing holding tension on the plug's tension tab.
3. Use an ohmmeter to test the electrical resistance of the sensor.
4. Measure the air temperature near the sensor and compare the required resistance against measured resistance. (See chart in reference section) If the sensor is within calibration, the sensor is good. If the sensor is out of calibration, replace the sensor. (Tube Sensors should be removed from socket and exposed to air temperature during test.)

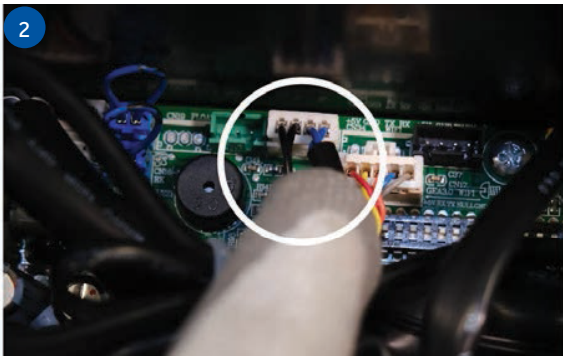

Testing Louver Motors

If the louver does not operate with command from the remote control, either the indoor board is bad, or the louver motor is defective. It is more likely the motor is defective than the board. (Make sure the louver assembly is not binding and keeping the vanes from moving.)

1. Remove power from the unit and remove the indoor unit cover.
2. Access the circuit board.
3. Identify the inoperable louver motor on the schematic drawing below and disconnect the plug from the circuit board.

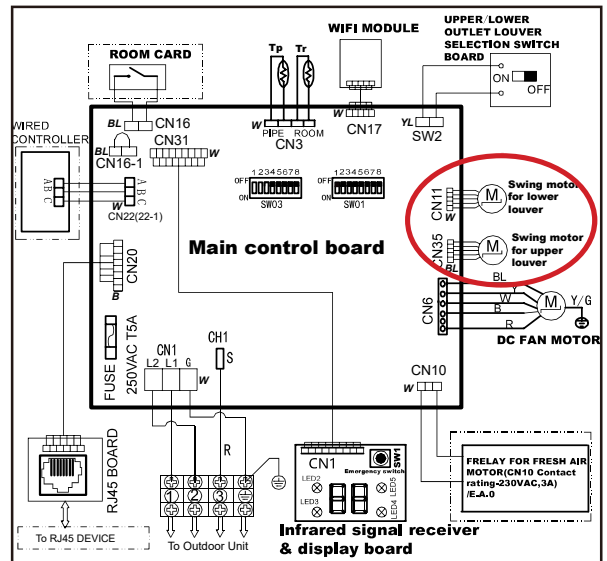

4. Use an Ohmmeter to test the electrical continuity of the louver motor windings. The proper resistance for each winding should be 292Ω from red wire (common) to any other wire.. If the motor winding resistance is erratic or shows open, the motor is defective. Replace the motor.

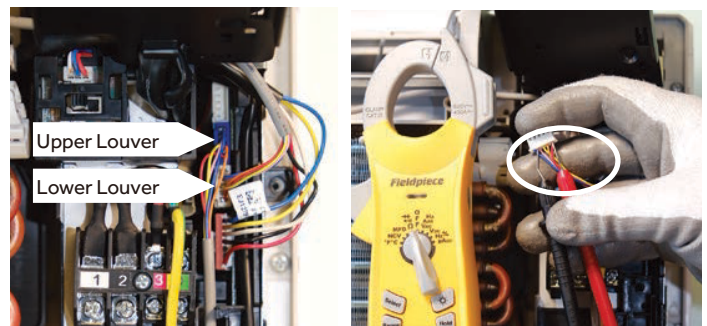

5. If the motor checks out good, replace the indoor control board.

Testing Communication Circuit

If an Error E7 occurs, perform the following test to determine if the indoor control board is functioning properly to send data to the outdoor unit.

Perform this test with the unit powered and all wiring connected between indoor and outdoor unit.

Make sure all wiring between the indoor and outdoor unit are correct. There should be no splices between the indoor and outdoor unit wiring connecting terminals 1 or 3. Make sure wiring is correct, before performing this test.

1. Measure the DC voltage between terminals 1 and 3 on the indoor terminal block.

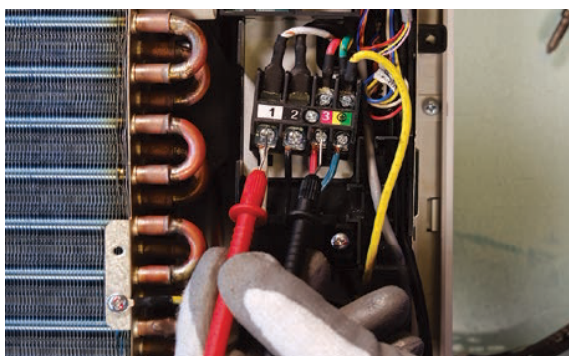

2. The voltage should fluctuate between 8VDC and 23VDC. The fluctuating signal indicates a good communication path.
3. If the voltage does not fluctuate, and the wiring is good, the indoor board is defective.

Replacing WiFi Module

1. Unplug existing WiFi module.
2. Insert new WiFi module.
3. Replace the wifi passcode sticker.
4. Pair the unit to account.

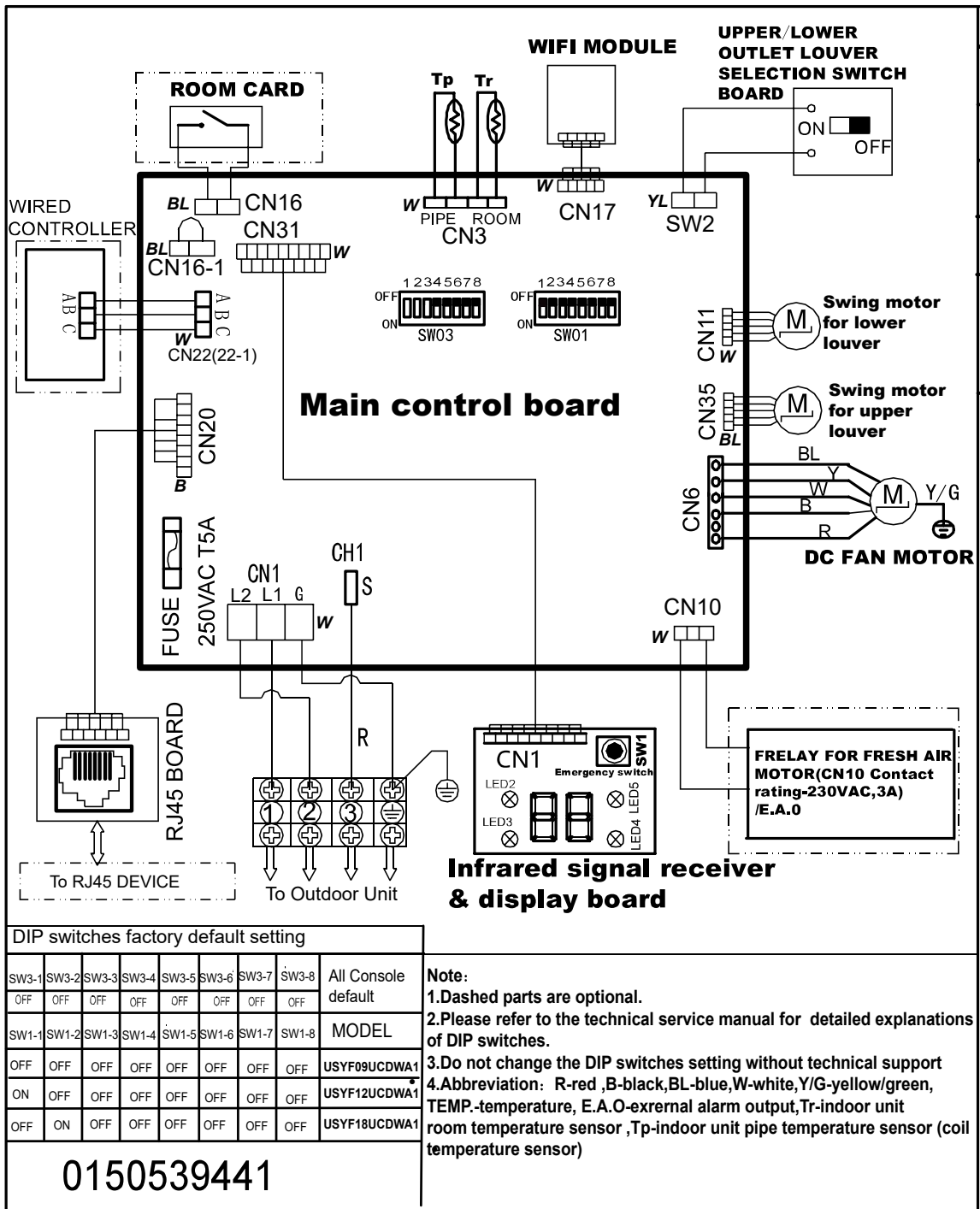

Error Codes

The error codes that are displayed on the indoor units may vary from the outdoor unit codes. The information communicated by the error code will be the SAME for both indoor and outdoor units even though the numbers may differ.

Indoor Display	Outdoor LED	Diagnosis
F12	1	Outdoor EEPROM failure
F1	2	IPM overcurrent or short circuit
F22	/	Outdoor alternating current, over current protection
F3	4	Communication failure between the IPM and outdoor PCB
F20*	5	Module operated overload (compressor overload protection)
F19*	6	Module low or high voltage
F27	/	Compressor current sampling circuit fault
F4	8	Overheat protection for discharge temperature
F8*	9	Malfunction of the DC*fan motor
F21	10	Malfunction of defrost temperature sensor
F7	11	Suction temperature sensor failure
F6	12	Ambient temperature sensor failure
F25	13	Discharge temperature sensor failure
F30*	/	High outdoor suction temperature
E7	15	Communication failure between the indoor & outdoor unit
F13*	16	Lack of refrigerant or discharging
F14*	17	4-way valve switching failure
F11	18	Loss of synchronism detection
F28	/	Position detection circuit fault of compressor
F15*	/	Terminal block temp too high
F5*	23	Module thermal overload
F2*	24	Compressor start failure, over-current
F23	25	Phase current protection (IPM)
F9	26	MCU reset
F24	27	Module current detect circuit malfunction
F10	28	Liquid pipe sensor failure: Circuit A
F16	29	Liquid pipe sensor failure: Circuit B
F17	30	Liquid pipe sensor failure: Circuit C
F18	31	Liquid pipe sensor failure: Circuit D
F29	32	Gas pipe sensor failure: Circuit A
F30	33	Gas pipe sensor failure: Circuit B
F31	34	Gas pipe sensor failure: Circuit C
F32	35	Gas pipe sensor failure: Circuit D
F26	36	Gas pipe sensor failure: Circuit E
F34	/	Outdoor pipe temperature protection in cooling mode
F35	38	Malfunction of module temperature sensor momentary power failure detection
F36	39	Malfunction of condensing temperature sensor
F33	40	Liquid pipe sensor failure: Circuit E
F38	41	Toci temperature sensor failure
F39	42	High Pressure switch open
F40	43	Low Pressure switch open
F41	44	System high pressure protection: Overcharged, high condensing temperature or malfunction of fan motor
F42	45	System low pressure protection: Undercharged, low defrosting temperature, or malfunction of fan motor
F43	/	Incorrect match between indoor & outdoor
E1	/	Indoor ambient temperature sensor failure
E2	/	Indoor coil temperature sensor failure
E4	/	Indoor PCB EEPROM failure
E8	/	Communication fault between the controller and Indoor unit
E12	/	Drain system malfunction
E13 / C1	/	Zero cross signal detected wrong
E14	/	Indoor fan motor malfunction

* Hidden indoor error code. LED1 will flash outdoors, but no error will appear on indoor unit display. To view error code on indoor display, press and hold the Emergency button for 15 seconds.

Table of Contents

System Power	63
Cool Mode	63
<i>Overview.....</i>	63
<i>Indoor Unit.....</i>	63
<i>Temperature Sensors.....</i>	63
<i>Communication.....</i>	63
<i>Outdoor Unit.....</i>	63
<i>Temperature Sensors.....</i>	64
<i>Call to Terminate Cooling</i>	64
<i>Freeze Protection Function.....</i>	64
Heat Mode.....	64
<i>Overview.....</i>	64
<i>Cold Air Proof Operation.....</i>	64
<i>Defrost.....</i>	65
<i>Automatic Heating Temperature Compensation.....</i>	65
<i>Indoor Unit.....</i>	65
<i>Temperature Sensors.....</i>	65
<i>Communication.....</i>	65
<i>Outdoor Unit.....</i>	65
<i>Temperature Sensors.....</i>	65
<i>Call to Terminate Heating</i>	66
Auto Mode.....	66
Dry Mode	66
<i>Overview.....</i>	66
<i>Indoor Unit.....</i>	66
<i>Temperature Sensors.....</i>	66
<i>Communication.....</i>	66
<i>Outdoor Unit.....</i>	66
<i>Temperature Sensors.....</i>	67
Defrost Operation.....	67
Protection Functions	67
<i>High Temperature Protection.....</i>	67
<i>Overheating Protection for Indoor Unit.....</i>	67
<i>Compressor Overcurrent Protection.....</i>	68
<i>Anti-freeze Protection of the Coil.....</i>	68
<i>Base Pan Heater</i>	68
Special Functions	69
<i>Auto Restart</i>	69
<i>Timed Defrost.....</i>	69
<i>Demand Defrost</i>	69
<i>Indoor Temperature Display</i>	69
<i>Temperature Compensation.....</i>	69
<i>RJ45.....</i>	69

System Power

The 230 Volt AC power for the system connects to terminals 1(N), 2(L), and ground of the outdoor unit terminal block. This terminal block also has terminals to connect power to the indoor unit.

The voltage readings between terminals 1(N) and ground, and terminals 2(L) and ground should be 120 VAC. The voltage reading between terminals 1(N) and 2(L) should be 230 VAC.

One additional connection on the terminal block (3) is for the communication wire between the indoor and outdoor units.

NOTE: Mis-wiring of these connections may cause improper operation or damage to system components.

Cool Mode

Overview

The temperature control range in cooling mode is 60°F - 86°F. The temperature set by the remote control and the indoor unit ambient temperature sensor will determine if a call for cooling is needed. If a call for cooling is justified, the call is communicated from the indoor unit to the outdoor unit. The indoor unit louver will open using a stepper motor, and the indoor fan will operate at the speed last set. The outdoor unit will determine the position of the EEV and speed frequency of the compressor. There can be a delay of up to 3 minutes before the outdoor unit fan and compressor start.

The speed of the indoor fan can be controlled manually by the user or automatically by the system. The speed can be changed between LOW, MEDIUM, and HIGH.

The predetermined conditions for automatic control are as follows:

(Tr = room temperature Ts = set temperature)

High Speed: $Tr \geq Ts + 5.4^{\circ}\text{F}$

Medium Speed: $Ts + 1.8^{\circ}\text{F} \leq Tr < Ts + 5.4^{\circ}\text{F}$

Low Speed: $Tr \leq Ts + 1.8^{\circ}\text{F}$ or when the sensor is off.

There will be a 2 second delay when manually controlling the speed.

The outdoor unit temperature sensors: outdoor ambient, defrost, suction line, and compressor discharge, used in conjunction with the indoor temperature sensors, indoor ambient and coil, provide information to the outdoor control board to monitor the system and regulate the frequency of the compressor, the EEV, and outdoor fan speed, to achieve the desired room temperature.

When the call for cooling has been satisfied, the compressor will turn off, followed by the outdoor fan. The indoor unit fan will continue to run.

If the system detects a malfunction, it may shut down or show an error code. This code will be shown on the indoor display board or a flashing LED will appear on the outdoor PCB.

Indoor Unit

To enter the cool mode, point the infrared remote control at the indoor unit and press the power button, then press the COOL mode button if not already set to cool mode.

The signals received by the infrared receiver are relayed to the main board of the indoor unit to turn the system on and set it to cool mode.

The indoor unit PCB will illuminate the display, indicating the set temperature and current status of the unit.

The PCB will signal the stepper motor to open the louver to either a stationary position, or one of several oscillating modes.

As the louver opens, the indoor unit main board will power up the indoor fan motor, operating the fan at the speed last set. The indoor fan motor has a feedback circuit which provides the indoor unit main board with information for controlling the speed of the fan motor.

Temperature Sensors

The indoor unit has two sensors that provide temperature information to the main board. The sensors: an indoor ambient temperature sensor, and pipe temperature sensor, are used for controlling the system during cool mode. The resistance values of the sensors will vary with temperature. The resistance to temperature values can be found using a temperature / resistance chart specific to the sensor being checked.

Communication

The indoor and outdoor unit main boards communicate via a digital signal on the wire connected to terminal 3 of each unit. A splice or break in this wire will cause a communication error.

When a command is received from the remote control, the indoor unit main board communicates with the outdoor unit main board to perform the requested function.

Outdoor Unit

Upon a request for cooling, the outdoor unit main board applies power to the outdoor fan motor and compressor. Depending on system cycling, there may be up to a 3 minute wait period before the compressor and outdoor fan start.

WARNING: Do not measure compressor voltages as damage to the meter may result.

If the room temperature is less than the set temperature, yet higher than 2°F below the set temperature, the system will adjust the speed of the compressor automatically.

The outdoor unit main board also controls the position of the EEV (Electronic Expansion Valve) to regulate the flow of refrigerant to the indoor unit evaporator coil.

Temperature Sensors

Four temperature sensors located in the outdoor unit provide temperature information to the outdoor unit main board for control of the system during cool mode.

The outdoor ambient temperature sensor provides the temperature of the air drawn into the condenser coil.

The defrost temperature sensor provides the temperature sensed at the output of the condenser coil.

The suction line temperature sensor provides the temperature sensed at the incoming suction line pipe.

The compressor discharge sensor provides the temperature sensed at the discharge pipe of the compressor.

Call to Terminate Cooling

The system will terminate cooling when the indoor ambient temperature sensor is equal to or lower than 2°F of the room set temperature. The indoor control board will communicate to the outdoor control board to de-energize the compressor. The outdoor fan will run for 60 seconds before stopping.

The indoor fan motor and louver will continue operating after cooling has been terminated.

To stop cool mode, press the power button to turn the system off, or change to another mode.

Freeze Protection Function

When the compressor operates continuously for 10 seconds and the temperature of the indoor coil has been below 32°F for 10 seconds, the compressor will stop. The indoor unit fan will continue to operate. When the temperature of the indoor coil rises to 45°F for more than 3 minutes the compressor will restart and the system will continue functioning.

Heat Mode

Overview

The temperature control range in heating mode is 60°F - 86°F. The temperature set by the remote control and the indoor unit ambient temperature sensor will determine if a call for heat is needed. If a call for heat is justified, a temperature compensation adjustment is automatically added to the

operating parameter and the call is communicated from the indoor unit to the outdoor unit.

The indoor unit louver will open using a stepper motor. The indoor fan will not operate at this time.

The outdoor unit will shift the 4-way valve to the heat mode position and determine the position of the EEV and speed (frequency) of the compressor. There can be a delay of up to 3 minutes before the outdoor unit fan and compressor start.

(Tr = room temperature Ts = set temperature)

If $Tr \leq Ts$, the outdoor unit will operate and the indoor fan operates in cold air prevention function

If $Tr > Ts$, the outdoor unit turns off and the indoor fan operates at heat residue sending mode.

If $Tr < Ts$, the outdoor unit will restart and the indoor fan operates in cold air proof mode.

The speed of the indoor fan can be controlled manually by the user or automatically by the system. The speed can be changed between HIGH, MEDIUM, and LOW. The predetermined conditions for automatic control are as follows:

High Speed: $Tr < Ts$

Medium Speed: $Ts \leq Tr \leq Ts + 4^\circ\text{F}$

Low Speed: $Tr > Ts + 4^\circ\text{F}$

When the indoor fan is running in automatic mode when the speed switches from high to low, the indoor fan will maintain high speed for a period of 3 minutes before switching to low speed.

Cold Air Proof Operation

At initial start of heat mode, indoor blower will not be turned on immediately until indoor coil temperature senses a minimum temperature. This period usually takes 30 seconds to 3 minutes depending on the outdoor temperature.

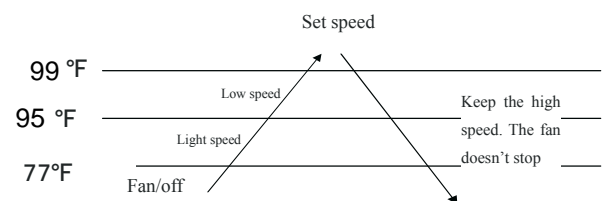

4 minutes after the indoor fan starts, the light or low speed will switch to the set speed.

Residual heat sending: the indoor fan will operate on low speed until the coil temperature reaches 77 degrees.

The outdoor unit temperature sensors: outdoor ambient, defrost, suction line, and compressor discharge, used in conjunction with the indoor coil and room temperature

sensors, provide information to the outdoor control board to monitor the system and regulate the speed of the compressor, the EEV and outdoor fan speed to achieve the desired room temperature.

When heating has been satisfied, the compressor will turn off first, followed by the outdoor fan. The 4-way valve will de-energize 2 minutes after compressor stops.

The indoor unit fan will continue to run at minimum speed until indoor coil temperature reaches a minimum temperature, when it will turn off.

If the system detects a malfunction, it may shut down or show an error code on the indoor unit display board and/or outdoor unit main board LED.

Defrost

When the system initiates a call for defrost, the indoor fan motor stops. The indoor unit display will not change. Any indoor unit malfunctions will be ignored at this time. The system will cycle through the defrost operation. Any indoor unit malfunctions will be ignored until the compressor restarts and has been operating for 30 seconds. At the conclusion of the defrost cycle, the indoor fan will enter the cold air proof operation. Heat mode resumes.

Automatic Heating Temperature Compensation

When the system enters heating mode, a temperature compensation adjustment is added to the operating parameter. This adjustment is canceled when exiting heat mode.

Indoor Unit

To enter the heat mode, point the infrared remote controller at the indoor unit and press the power button, then press the HEAT mode button if not already set to heat mode.

The signals received by the infrared receiver are relayed to the main board of the indoor unit to turn the system on and set it to heat mode.

The indoor unit PCB will activate the display of the indoor unit, illuminating the display and indicating the set temperature and current status of the unit.

The indoor unit PCB will signal the stepper motor to open the louver to a stationary position.

The PCB will power up the indoor fan motor after the outdoor unit has started and heating of the indoor coil has taken place (see cold air proof operation). The motor has a feedback circuit which provides information for controlling the speed of the fan motor.

Temperature Sensors

The indoor unit has two sensors that provide temperature information to the indoor unit main board. The sensors: a room temperature sensor, and pipe temperature sensor, are used for controlling the system during heat mode.

The resistance values of the sensors will vary with temperature. The resistance to temperature values can be found using a temperature /resistance chart specific to the sensor being checked.

Communication

The indoor and outdoor unit main boards communicate via a digital signal on the wire connected to terminal 3 of each unit. A splice or break in this wire will cause a communication error.

When a command is received from the remote control, the indoor unit main board communicates with the outdoor unit to perform the requested function.

Outdoor Unit

Upon a request for heat, the outdoor unit PCB applies power to the 4-way valve, outdoor fan motor, and compressor. Depending on system cycling, there may be up to a 3 minute wait period before the compressor and outdoor fan start.

If the room temperature is above the set temperature, yet lower than 2°F above the set temperature, the system will adjust the running frequency of the compressor automatically.

The outdoor unit main board also controls the position of the EEV (Electronic Expansion Valve) to regulate the flow of refrigerant to the outdoor unit evaporator coil.

Temperature Sensors

Four temperature sensors located in the outdoor unit provide temperature information to the PCB for control of the system during heat mode.

The ambient temperature sensor provides the temperature of the air drawn into the condenser coil.

The defrost temperature sensor provides the temperature sensed at the output of the condenser coil.

The suction line temperature sensor provides the temperature sensed at the incoming suction line pipe.

The compressor discharge sensor provides the temperature sensed at the discharge pipe of the compressor.

Call to Terminate Heating

The system will call to terminate heating when the indoor temperature is equal to or higher than 2°F above the room set temperature. The indoor control board will communicate to the outdoor control board to de-energize the compressor. The outdoor fan will run for 60 seconds before stopping. The 4-way valve will de-energize 2 minutes after the compressor stops.

To stop heat mode, press the power button to turn the system off, or change to another mode.

Auto Mode

With the system turned on, press the AUTO button on the remote control. The system will change to the auto mode of operation.

As the room is cooled or heated, the system will automatically switch between cool mode, fan mode, and heat mode. There is a minimum 15 minute operating time between mode changes.

Dry Mode

Overview

The temperature control range is 60°F - 86°F. This mode is used for dehumidification.

(T_r = room temperature T_s = set temperature)

When $T_r > T_s + 4^\circ\text{F}$, the compressor will turn on and the indoor fan will operate at the set speed.

When $T_s \leq T_r \leq T_s + 4^\circ\text{F}$, the compressor will operate at the high dry frequency for 10 minutes, then at the low dry mode for 6 minutes. The indoor fan will operate at low speed.

When $T_r < T_s$, the outdoor unit will stop, and the indoor fan will stop for 3 minutes, then operate at the low speed option.

Automatic fan speed:

When $T_r \geq T_s + 9^\circ\text{F}$, High speed

When $T_s + 5.4^\circ\text{F} \leq T_r < T_s + 9^\circ\text{F}$, Medium speed

When $T_s + 3.6^\circ\text{F} \leq T_r < T_s + 5.4^\circ\text{F}$, Low speed

When $T_r < T_s + 3.6^\circ\text{F}$, Light speed

Note: TURBO and QUIET mode must be set using the remote controller.

If the outdoor fan is stopped, the indoor fan will pause for 3 minutes.

If the outdoor fan is stopped for more than 3 minutes, and the compressor is still operating, the system will change to light speed mode.

Indoor Unit

To enter the dry mode, point the infrared remote control at

the indoor unit and press the power button, then press the DRY mode button if not already set to dry mode.

The signals received by the infrared receiver are relayed to the main board of the indoor unit to turn the system on and set it to dry mode.

The indoor unit main board will illuminate the display, indicating the set temperature and current status of the unit.

The PCB will then signal the louver stepper motor to open the louver to either a stationary position, or one of several oscillating modes.

As the louver opens, the indoor fan motor will operate at the speed last set. The fan motor has a feedback circuit which provides the main board with information for controlling the speed of the fan motor.

Temperature Sensors

The indoor unit has two sensors that provide temperature information to the PCB. An ambient temperature sensor and pipe temperature sensor are used for controlling the system during dry mode. The resistance values of the sensors will vary with temperature. The resistance to temperature values can be found using a temperature /resistance chart specific to the sensor being checked.

Communication

The indoor and outdoor unit main boards communicate via a digital signal on the wire connected to terminal 3 of each unit. A splice or break in this wire will cause a communication error.

When a command is received from the remote control, the indoor unit main board communicates with the outdoor unit main board via the terminal 3 wire to perform the requested function.

Outdoor Unit

Upon a request for dry mode, the outdoor unit main board applies power to the fan motor and compressor. Depending on system cycling, there may be up to a 3 minute wait period before the compressor and outdoor fan start.

The outdoor unit PCB also controls the position of the EEV (Electronic Expansion Valve) to regulate the flow of refrigerant to the indoor unit evaporator coil

Temperature Sensors

Four temperature sensors located in the outdoor unit provide information to the outdoor unit PCB for control of the system during dry mode.

The outdoor ambient temperature sensor provides the temperature of the air drawn into the condenser coil.

The defrost temperature sensor provides the temperature sensed at the output of the condenser coil.

The suction line temperature sensor provides the temperature sensed at the incoming suction line pipe.

The compressor discharge sensor provides the temperature sensed at the discharge pipe of the compressor.

To stop dry mode, press the power button to turn the system off, or change to another mode.

Defrost Operation

To enter the defrost mode, the compressor must have accumulated 10 minutes of run time, and 45 minutes of accumulated run time since the last defrost cycle.

When the defrost cycle begins, the following conditions take place:

1. The compressor will stop for 1 minute
2. The outdoor fan will continue to operate at high speed.
3. After 50 seconds, the 4-way valve will shift to the cool mode position.
4. 5 seconds later the outdoor fan will stop.
5. After 1 minute, the compressor will start.

The outdoor unit will now defrost.

The defrost cycle runs continuously for approximately 10 minutes.

The system will exit the defrost cycle if any of the following conditions are met:

1. The condenser maintains a temperature above 45°F for 80

seconds.

2. The condenser maintains a temperature above 54°F for 5 seconds.

Upon exiting the defrost cycle, the following conditions will take place:

1. The compressor will stop.
2. The outdoor fan will operate at high speed.
3. 50 seconds later the 4-way valve will shift to the heat mode position.
4. 60 seconds later the compressor will start.

The system resumes normal operation.

1. Compressor High Temperature

The compressor discharge pipe sensor (exhaust temp) senses the temperature of the refrigerant exiting the compressor. The sensed temperature received from the sensor by the control circuitry will cause the compressor frequency to increase or decrease. (see chart below). If a temperature of $\geq 230^\circ\text{F}$ is sensed for 20 seconds, an exhaust overheating protection error code will be indicated at the outdoor unit.

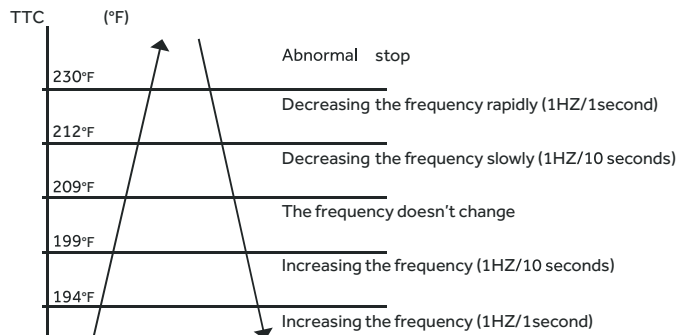

2. Overheating Protection for Indoor Unit

A sensor monitors coil temperature in both heating and cooling modes, and causes the compressor to speed up, slow down, or stop, according to the chart below.

Overheating Protection for Indoor Unit					
Model	Increasing slowly	Holds value	Decreasing slowly	Decreasing rapidly	Compressor stops
09K	40°C / 104°F	52°C / 126°F	57°C / 135°F	60°C / 140°F	63°C / 145°F
12K	40°C / 104°F	52°C / 126°F	57°C / 135°F	60°C / 140°F	63°C / 145°F
18K	40°C / 104°F	52°C / 126°F	57°C / 135°F	60°C / 140°F	63°C / 145°F

3. Compressor Over-current Protection

If the current draw of the compressor at start-up is greater than the values listed on the chart below for approximately 3 seconds, the compressor will stop. After 3 minutes the compressor will restart. If the over-current condition occurs 3 times in 20 minutes, the system will lock-out, and a code will be indicated at the outdoor unit. It will be necessary to remove power to the system to reset the lock-out condition.

Current Overload Protection				
Model	Holds value	Decrease 1Hz/10s	Decrease 1Hz/s	Over-current point
09K	8A	9A	10A	12A
12K	13A	14A	15A	16A
18K	15A	16A	17A	18A

4. Anti-freeze Protection of the Indoor Coil

The temperature sensed by the coil sensor is used to determine at what speed the compressor is to run to avoid the coil temperature being too cold.

Tpg_indoor: indoor unit pipe sensor temperature

Ts: outdoor unit Suction Line sensor temperature

When $\text{Min}(Tpg_indoor, (Tpg_indoor+Ts)/2) < Tpg1$, the frequency of the compressor decreases at the rate of 1HZ / 1 second.

When $\text{Min}(Tpg_indoor, (Tpg_indoor+Ts)/2) < Tpg2$, the frequency of the compressor decreases at the rate of 1HZ / 10 second.

When Tpg_indoor begins to rise again, and $Tpg2 \leq \text{Min}(Tpg_indoor, (Tpg_indoor+Ts)/2) \leq Tpg3$, the frequency of the compressor does not change.

When $Tpg3 < \text{Min}(Tpg_indoor, (Tpg_indoor+Ts)/2) < Tpg4$, the frequency of the compressor increases at the rate of 1HZ / 10 second

Example: if $\text{Min}(Tpg_indoor, (Tpg_indoor+Ts)/2) \leq 32^\circ\text{F}$ sustains for 2 minutes, the outdoorunit will stop and indicate an underload malfunction code at the outdoor unit. The compressor stops for a minimum of 3 minutes. When $\text{Min}(Tpg_indoor, (Tpg_indoor+Ts)/2) > Tpg4$, the compressor will restart

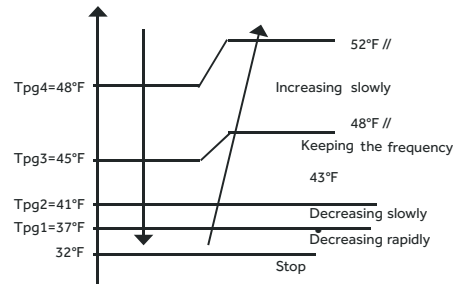

5. Base Pan Heater

To keep condensate water from freezing inside the cabinet, a base pan heater is installed at the factory. Refer to the chart below for the operating parameters.

Pan Heater Logic	
Outdoor Temperature	Pan Heater
● $> 37^\circ\text{F} / 3^\circ\text{C}$	● OFF
● $28^\circ\text{F} / -2^\circ\text{C}$ to $34^\circ\text{F} / 1^\circ\text{C}$	● OFF 20min, ON 10min
● $10^\circ\text{F} / -12^\circ\text{C}$ to $25^\circ\text{F} / -4^\circ\text{C}$	● OFF 15min, ON 15min
● $< 10^\circ\text{F} / -12^\circ\text{C}$	● ON

Special Functions

Auto Restart

When this is enabled, the following functions will automatically resume after a power loss:

- ON/OFF State, Mode of Operation, Fan Speed, Temperature Setpoint, Louver Swing settings.
- If there was a timer set or the system was in Sleep mode, they will be canceled upon restart

Wired Controller:

- Auto Restart is Enabled by Default

Wireless Controller:

- Enable: Press the Sleep button 10 times within 7 seconds. You will hear 4 beeps as confirmation
- Disable: Press the Sleep button 10 times within 7 seconds. You will hear 2 beeps as confirmation

Timed Defrost

Timed Defrost via Remote Controller (YR-HG): (Same as dip switch 1 and 2 OFF)

Setting method:

1. Set to HEAT Mode
2. Set to 30°C/86°F
3. Set High Fan Speed
4. Press Temperature + Button 10 times within 7 seconds
5. Hear Unit will Beep 7 times to Confirm

Cancel method:

Same process as Setting Method. Hear Unit Beep 5 times to confirm of cancel function.

[This page intentionally left blank.]

Demand Defrost

Force defrost via Remote Controller (YR-HG):

Setting method:

- 1) Set to HEAT Mode
- 2) Set to 30°C/86°F
- 3) Set High Fan Speed
- 4) Press Health Button 10 times within 5 seconds
- 5) Hear Unit will Beep 4 times to Confirm, System will enter Force Defrost mode.

Indoor Temperature Display

This function will allow you to set the display to show either the Ambient temperature or the setpoint:

Set temperature: Press the Light button 10 times within 5 second, Hear Unit will Beep 4 times to confirm

Ambient temperature: Press the Light button 10 times within 5 second, Hear Unit will Beep 2 times to confirm

Temperature Compensation

This function allows you the capability to adjust the temperature compensation offset of any indoor unit. The adjusted value is programmed into the EEPROM.

Logic: The Actual Ambient Temperature = The Display Ambient Temperature + Temperature Compensation

Guide:

1. Apply power to the unit.
2. Set to Cooling Mode or Heating Mode
3. Set the temperature to 24 °C.
4. Press the SLEEP button 7 times within 5 seconds. Indoor PCB will Beep 2 times to confirm.
5. 24 °C will be the starting/reference point for the Temperature Compensation. Temperature Compensation can be adjusted from -8 °C to +6 °C. Example: if you want to set the Temperature Compensation value by 4 °C, then set the temperature to 28 °C.
6. Once the desired value has been selected, turn OFF the unit via the YR-HG controller to save the compensation settings.

RJ45

The Bluetooth module will connect to the unit physically via RJ45 (Service Port), and connect to the laptop via USB

We can use it to achieve the following functions:

1. Software Updates
2. Real Time Sensor Readings / Load Control
3. View Alerts, Fault Data, Cycle History, Graphs
4. Automated Diagnostic Tests
5. Data Collection

Resistance Chart / Sensor Definitions

Abbr.	Definition	Type
tAo	Temperature of outdoor ambient	10K
tc	Temperature of outdoor condenser	10K
td	Temperature of outdoor discharge	50K
tE	Temperature of outdoor defrost	10K
tS	Temperature of outdoor suction	10K
tdr	Temperature of compressor driver module	10K
ldr	Current of the compressor	10K

Abbr.	Definition	Type
tAI	Temperature of indoor ambient	10K
TCl	Temperature of indoor condenser	10K
Toci	Hot Gas Leaving the 4-Way Valve	10K
Tc2	EEV Liquid Sensor	10K
Tc1	EEV Gas Sensor	10K
Tm	Module Temp Sensor	10K
TAI	Temperature of indoor ambient (9K/12K Tempo & All CAC)	23K

10K Sensors: Ambient (all except ducted, cassette, and 9K-12K Tempo) suction, gas, defrost, and pipe sensors.

23K Sensors: Ambient sensors for ducted, cassette, and 9K-12K Tempo

50K Sensors: Discharge sensors

°F	°C	Normal (KΩ)		
		10K SENSORS	23K SENSORS	50K SENSORS
-22	-30	147.95	513.115	12061.74
-20.2	-29	139.56	478.894	11267.87
-18.4	-28	131.70	447.408	10531.37
-16.6	-27	124.34	418.379	9847.72
-14.8	-26	117.44	391.564	9212.81
-13	-25	110.96	366.751	8622.85
-11.2	-24	104.89	343.754	8074.38
-9.4	-23	99.19	322.407	7564.22
-7.6	-22	93.83	302.567	7089.47
-5.8	-21	88.80	284.105	6647.45
-4	-20	84.07	266.905	6235.71
-2.2	-19	79.62	250.866	5851.99
-0.4	-18	75.44	235.895	5494.21
1.4	-17	71.50	221.911	5160.46
3.2	-16	67.79	208.838	4849.00
5	-15	64.30	196.609	4558.19
6.8	-14	61.01	185.163	4286.55
8.6	-13	57.91	174.443	4032.71
10.4	-12	54.99	164.399	3795.39
12.2	-11	52.23	154.983	3573.43
14	-10	49.62	146.153	3365.73
15.8	-9	47.17	137.87	3171.31
17.6	-8	44.85	130.096	2989.25
19.4	-7	42.65	122.799	2818.67
21.2	-6	40.58	115.946	2658.81
23	-5	38.62	109.51	2508.91
24.8	-4	36.77	103.462	2368.32
26.6	-3	35.01	97.779	2236.39
28.4	-2	33.36	92.437	2112.55
30.2	-1	31.78	87.415	1996.25
32	0	30.30	82.691	1887.00
33.8	1	28.89	78.248	1784.33
35.6	2	27.55	74.067	1687.81
37.4	3	26.29	70.133	1597.04
39.2	4	25.09	66.43	1511.65
41	5	23.95	62.943	1431.28
42.8	6	22.87	59.659	1355.62
44.6	7	21.84	56.566	1284.36
46.4	8	20.87	53.651	1217.23
48.2	9	19.94	50.904	1153.96
50	10	19.06	48.314	1094.32
51.8	11	18.23	45.872	1038.07
53.6	12	17.43	43.569	985.01
55.4	13	16.68	41.395	934.94
57.2	14	15.96	39.343	887.68
59	15	15.28	37.406	843.05
60.8	16	14.63	35.577	800.89
62.6	17	14.01	33.848	761.06
64.4	18	13.42	32.215	723.41
66.2	19	12.86	30.671	687.82
68	20	12.32	29.21	654.16
69.8	21	11.81	27.828	622.32
71.6	22	11.33	26.521	592.18
73.4	23	10.86	25.283	563.66
75.2	24	10.42	24.111	536.65
77	25	10.00	23	511.08
78.8	26	9.60	21.947	486.94

°F	°C	Normal (KΩ)		
		10K SENSORS	23K SENSORS	50K SENSORS
80.6	27	9.21	20.949	464.05
82.4	28	8.85	20.003	442.35
84.2	29	8.50	19.104	421.77
86	30	8.16	18.252	402.24
87.8	31	7.84	17.442	383.72
89.6	32	7.54	16.674	366.13
91.4	33	7.25	15.943	349.43
93.2	34	6.97	15.249	333.58
95	35	6.70	14.588	318.52
96.8	36	6.45	13.96	304.22
98.6	37	6.20	13.362	290.62
100.4	38	5.97	12.794	277.70
102.2	39	5.75	12.252	265.41
104	40	5.53	11.736	253.73
105.8	41	5.33	11.244	242.62
107.6	42	5.13	10.776	232.04
109.4	43	4.94	10.329	221.98
111.2	44	4.76	9.904	212.41
113	45	4.59	9.497	203.29
114.8	46	4.43	9.11	194.61
116.6	47	4.27	8.74	186.34
118.4	48	4.11	8.387	178.46
120.2	49	3.97	8.05	170.95
122	50	3.83	7.728	163.80
123.8	51	3.69	7.421	156.97
125.6	52	3.57	7.127	150.47
127.4	53	3.44	6.846	144.26
129.2	54	3.32		138.35
131	55	3.21		132.70
132.8	56	3.10		127.31
134.6	57	2.99		122.16
136.4	58	2.89		117.25
138.2	59	2.79		112.56
140	60	2.70		108.08
141.8	61	2.61		103.80
143.6	62	2.52		99.70
145.4	63	2.44		95.79
147.2	64	2.36		92.06
149	65	2.28		88.48
150.8	66	2.21		85.06
152.6	67	2.14		81.79
154.4	68	2.07		78.66
156.2	69	2.00		75.67
158	70	1.94		72.80
159.8	71	1.88		70.06
161.6	72	1.82		67.43
163.4	73	1.76		64.91
165.2	74	1.71		62.50
167	75	1.65		60.19
168.8	76	1.60		57.98
170.6	77	1.55		55.86
172.4	78	1.51		53.82
174.2	79	1.46		51.87
176	80	1.41		50.00
177.8	81	1.37		48.21
179.6	82	1.33		46.48
181.4	83	1.29		44.83

°F	°C	Normal (KΩ)		
		10K SENSORS	23K SENSORS	50K SENSORS
183.2	84	1.25		43.25
185	85	1.22		41.72
186.8	86	1.18		40.26
188.6	87	1.14		38.85
190.4	88	1.11		37.50
192.2	89	1.08		36.21
194	90	1.05		34.96
195.8	91	1.02		33.77
197.6	92	0.99		32.62
199.4	93	0.96		31.51
201.2	94	0.93		30.45
203	95	0.91		29.42
204.8	96	0.88		28.44
206.6	97	0.86		27.50
208.4	98	0.83		26.59
210.2	99	0.81		25.71
212	100	0.79		24.87
213.8	101	0.76		24.06
215.6	102	0.74		23.28
217.4	103	0.72		22.52
219.2	104	0.70		21.80
221	105	0.68		21.10
222.8	106	0.67		20.43
224.6	107	0.65		19.78
226.4	108	0.63		19.16
228.2	109	0.61		18.56
230	110	0.60		17.98
231.8	111	0.58		17.42
233.6	112	0.57		16.88
235.4	113	0.55		16.36
237.2	114	0.54		15.85
239	115	0.52		15.37
240.8	116	0.51		14.90
242.6	117	0.50		14.45
244.4	118	0.48		14.01
246.2	119	0.47		13.59
248	120	0.46		13.19
249.8	121			12.80
251.6	122			12.42
253.4	123			12.05
255.2	124			11.70
257	125			11.35
258.8	126			11.02
260.6	127			10.70
262.4	128			10.40
264.2	129			10.10
266	130			9.81
267.8	131			9.53
269.6	132			9.26
271.4	133			9.00
273.2	134			8.74
275	135			8.50
276.8	136			8.26
278.6	137			8.03
280.4	138			7.81
282.2	139			7.60
284	140			7.39

Master Error Code Chart

Outdoor Pro-Series LED Display (CAC)	Outdoor Multi-Zone LED Display (CAC)	Outdoor Single-Zone LED1 Flash (RAC)	FAULT DESCRIPTION	HIGHWALL	CONSOLE	COMPACT CASSETTE	
				Digital Display	Digital Display	Panel LED Flash or ID PCB LED Flash	
						Yellow Timer LED (PCB LED5)	Green Run LED (PCB LED1)
1	1	1	Outdoor EEPROM failure	F12	F12	2	1
2	2	2	IPM overcurrent or short circuit	F1	F1	2	2
/	/	3	Outdoor alternating current, over current protection	F22	F22	2	3
3	/	/	Compressor over current during deceleration	/	/	/	/
4	4	4	Communication failure between the IPM and outdoor PCB	F3	F3	2	4
5	5	5	Module operated overload (compressor overload protection)	F20*	F20*	2	5
6	6	6	Module low or high voltage	F19*	F19*	2	6
7	/	7	Compressor current sampling circuit fault	F27	F27	2	7
8	8	8	Overheat protection for discharge temperature	F4	F4	2	8
9	9	9	Malfunction of the DC fan motor	F8*	F8*	2	9
10	10	10	Malfunction of defrost temperature sensor	F21	F21	3	0
11	11	11	Suction temperature sensor failure	F7	F7	3	1
12	12	12	Ambient temperature sensor failure	F6	F6	3	2
13	13	13	Discharge temperature sensor failure	F25	F25	3	3
/	/	14	High outdoor suction temperature	F30*	F30*	3	4
14	/	/	PFC circuit loop voltage	/	/	/	/
15	15	15	Communication failure between the indoor & outdoor unit	E7	E7	3	5
16	16	16	Lack of refrigerant or discharging	F13*	F13*	3	6
17	17	17	4-way valve switching failure	F14*	F14*	3	7
18	18	18	Loss of synchronism detection	F11	F11	3	8
/	/	19	Position detection circuit fault of compressor	F28	F28	3	9
19	/	/	Low DC or AC voltage	/	/	/	/
/	/	20	Terminal block temp too high	F15*	F15*	4	0
20	20	/	Indoor thermal overload	E9	/	4	0
/	21	21	Indoor unit overload protection, heating mode only.	E9*	/	4	1
/	21	/	Indoor coil frosted	E5	/	4	1
/	/	22	Indoor anti-frosting protection	E5*	/	4	2
22	/	/	PFC circuit loop overcurrent	/	/	/	/
/	/	23	Indoor coil temperature (abnormal reading)	/	/	/	/
23	23	/	Module thermal overload	F5*	F5*	4	3
24	24	24	Compressor start failure, over-current	F2*	F2*	4	4
25	25	25	Phase current protection (IPM)	F23*	F23	4	5
/	26	/	MCU reset	F9	F9	4	6
26	/	/	IPM power supply phase loss (3-phase)	/	/		
27	27	27	Module current detect circuit malfunction	F24	F24	4	7
28	/	/	Wiring error: Compressor to IPM	/	/	/	/

* Hidden indoor error code. LED1 will flash outdoors, but no error will appear on indoor unit display. To view error code on indoor display, press and hold the Emergency button for 15 seconds.

Master Error Code Chart

LARGE CASSETTE			DUCTED						WIRED CONTROLLER	
Panel LED Flash or ID PCB LED Flash		Panel Display (PB*****)	HIGH STATIC		MID-STATIC DUCT (MSP)		SLIM DUCT		YRE-17A QACT17A	YRE-16B
Yellow Timer LED (PCB LED4)	Green Run LED (PCB LED1)		LED4 (Yellow)	LED3 (Green)	LED4	LED3	LED4 (Yellow)	LED3 (Green)		
2	1	15	2	1	2	1	2	1	15	21
2	2	16	2	2	2	2	2	2	16	22
/	/	/	/	/	/	/	/	/	17	23
2	3	17	2	3	2	3	2	3	17	23
2	4	18	2	4	2	4	2	4	18	24
2	5	19	2	5	2	5	2	5	19	25
2	6	1A	2	6	2	6	2	6	1A	26
2	7	1B	2	7	2	7	2	7	1B	27
2	8	1C	2	8	2	8	2	8	1C	28
2	9	1D	2	9	2	9	2	9	1D	29
3	0	1E	3	0	3	0	3	0	1E	30
3	1	1F	3	1	3	1	3	1	1F	31
3	2	20	3	2	3	2	3	2	20	32
3	3	21	3	3	3	3	3	3	21	33
/	/	/	/	/	/	/	/	/	22	34
3	4	22	3	4	3	4	3	4	22	34
3	5	23	3	5	3	5	3	5	23	35
3	6	24	3	6	3	6	3	6	24	36
3	7	25	3	7	3	7	3	7	25	37
3	8	26	3	8	3	8	3	8	26	38
/	/	/	/	/	/	/	/	/	27	39
3	9	27	3	9	3	9	3	9	27	39
/	/	/	/	/	/	/	/	/	28	40
4	0	28	4	0	4	0	4	0	28	40
/	/	/	/	/	/	/	/	/	29	41
4	1	29	4	1	4	1	4	1	29	41
/	/	/	/	/	/	/	/	/	2A	42
4	2	2A	4	2	4	2	4	2	2A	42
/	/	/	/	/	/	/	/	/	/	/
4	3	2B	4	3	4	3	4	3	2B	43
4	4	2C	4	4	4	4	4	4	2C	44
4	5	2D	4	5	4	5	4	5	2D	45
4	6	2E	4	6	4	6	4	6	2E	46
/	/	/	/	/	/	/	/	/	2F	47
4	7	2F	4	7	4	7	4	7	2F	47
/	/	/	/	/	/	/	/	/	/	/

Master Error Code Chart

Outdoor Pro-Series LED Display (CAC)	Outdoor Multi-Zone LED Display (CAC)	Outdoor Single-Zone LED1 Flash (RAC)	FAULT DESCRIPTION	HIGHWALL	CONSOLE	COMPACT CASSETTE	
				Digital Display	Digital Display	Panel LED Flash or ID PCB LED Flash	
						Yellow Timer LED (PCB LED5)	Green Run LED (PCB LED1)
/	/	28	Low refrigerant flow. Lockout.	/	/	/	/
/	28	/	Liquid pipe sensor failure: Circuit A	F10	F10	4	8
/	29	/	Liquid pipe sensor failure: Circuit B	F16	F16	4	9
/	30	/	Liquid pipe sensor failure: Circuit C	F17	F17	5	0
/	31	/	Liquid pipe sensor failure: Circuit D	F18	F18	5	1
/	32	/	Gas pipe sensor failure: Circuit A	F29	F29	5	2
/	33	/	Gas pipe sensor failure: Circuit B	F30	F30	5	3
/	34	/	Gas pipe sensor failure: Circuit C	F31	F31	5	4
/	35	/	Gas pipe sensor failure: Circuit D	F32	F32	5	5
/	36	/	Gas pipe sensor failure: Circuit E	F26	F26	5	6
/	/	37	Outdoor pipe temperature protection in cooling mode	F34	F34	5	7
37	/	/	Compressor overcurrent detected by IPM	/	/	/	/
38	38	/	Malfunction of module temperature sensor momentary power failure detection	F35	F35	5	8
39	39	39	Malfunction of condensing temperature sensor	F36	F36	5	9
/	40	/	Liquid pipe sensor failure - Circuit E	F33	F33	6	0
/	41	/	Toci temperature sensor failure	F38	F38	6	1
42	42	/	High Pressure switch open	F39	F39	6	2
43	43	/	Low Pressure switch open	F40	F40	6	3
44	44	/	System high pressure protection: Overcharged, high condensing temperature or malfunction of fan motor.	F41	F41	6	4
45	45	/	System low pressure protection: Undercharged, low defrosting temperature, or malfunction of fan motor.	F42	F42	6	5
/	/	46	Incorrect match between indoor & outdoor	F43	F43	6	6
/	L0	/	OAT less than -22°F (-30°C)	/	/	/	/
/	/	/	Indoor ambient temperature sensor failure	E1	E1	0	1
/	/	/	Indoor coil temperature sensor failure	E2	E2	0	2
/	/	/	Indoor PCB EEPROM failure	E4	E4	0	4
/	/	/	Communication fault between the indoor and outdoor unit	/	/	0	7
/	/	/	Communication fault between the controller and Indoor unit	/	E8	0	8
/	/	/	DC voltage of the fan motor driver too high or too low	/	/	/	/
/	/	/	Fan motor driver over 95°F (35°C)	/	/	/	/
/	/	/	Indoor fan motor out of step	/	/	/	/
/	/	/	Drain system malfunction	/	E12	0	12
/	/	/	Zero cross signal detected wrong	/	E13 / C1	0	13
/	/	/	Indoor fan motor malfunction	E14*	E14	0	14
/	/	/	Indoor fan motor overcurrent	/	/	/	/

* Hidden indoor error code. LED1 will flash outdoors, but no error will appear on indoor unit display. To view error code on indoor display, press and hold the Emergency button for 15 seconds.

Master Error Code Chart

LARGE CASSETTE			DUCTED						WIRED CONTROLLER	
Panel LED Flash or ID PCB LED Flash		Panel Display (PB*****)	HIGH STATIC		MID-STATIC DUCT (MSP)		SLIM DUCT		YRE-17A QACT17A	YRE-16B
Yellow Timer LED (PCB LED4)	Green Run LED (PCB LED1)		LED4 (Yellow)	LED3 (Green)	LED4	LED3	LED4 (Yellow)	LED3 (Green)		
/	/	/	/	/	/	/	/	/	/	/
4	8	30	4	8	4	8	4	8	30	48
4	9	31	4	9	4	9	4	9	31	49
5	0	32	5	0	5	0	5	0	32	50
5	1	33	5	1	5	1	5	1	33	51
5	2	34	5	2	5	2	5	2	34	52
5	3	35	5	3	5	3	5	3	35	53
5	4	36	5	4	5	4	5	4	36	54
5	5	37	5	5	5	5	5	5	37	55
5	6	38	5	6	5	6	5	6	38	56
/	/	/	/	/	/	/	/	/	39	57
5	7	39	5	7	5	7	5	7	39	57
5	8	3A	5	8	5	8	5	8	3A	58
5	9	3B	5	9	5	9	5	9	3B	59
6	0	3C	6	0	6	0	6	0	3C	60
6	1	3D	6	1	6	1	6	1	3D	61
6	2	3E	6	2	6	2	6	2	3E	62
6	3	3F	6	3	6	3	6	3	3F	63
6	4	40	6	4	6	4	6	4	40	64
6	5	41	6	5	6	5	6	5	41	65
/	/	/	/	/	/	/	/	/	42	66
/	/	/	/	/	/	/	/	/	/	/
0	1	01	0	1	0	1	0	1	01	01
0	2	02	0	2	0	2	0	2	02	02
0	4	04	0	4	0	4	0	4	04	04
0	7	07	0	7	0	7	0	7	07	07
0	8	08	0	8	0	8	0	8	Flashing 07 (YR-E17) / Flashing ! (QACT17A)	/
/	/	/	0	17	/	/	0	17	11	17
/	/	/	0	18	/	/	0	18	12	18
/	/	/	0	19	/	/	0	19	13	19
0	12	0C	0	12	0	12	0	12	0C	12
0	13	0D	0	13	0	13	0	13	0D	13
0	14	0E	0	14	0	14	0	14	0E	14
/	/	/	0	15	/	/	0	15	0F	15

Table of Contents

Check This First Outdoor Unit	76
Check This First Indoor Unit	77
Wiring Diagram Reference.....	78
Error Code (Indoor/outdoor)	
F1/LED1: 2 Flash	79
F2/LED1: 24 Flash	81
F3/LED1: 4 Flash	83
F4/LED1: 8 Flash	85
F6/LED1: 12 Flash	
F7/LED1: 11 Flash	
F21/LED1: 10 Flash	
F25/LED1: 13 Flash	
E1/LED1: No Flash	
E2/LED1: No Flash	87
F6/LED1: 12 Flash, F7/LED1: 11 Flash, F21/LED1: 10 Flash, F25/LED1: 13 Flash,	
E1/LED1: No Flash, E2/LED1: No Flash.....	88
F8/LED1: 9 Flash	89
F11/LED1: 18 Flash	91
F12/LED1: 1 Flash	93
E5/LED1: 22 Flash.....	94
E7/LED1: 15 Flash	96
Error Code (Indoor)	
E14	99
Checking System Components.....	101

Conditions Needed for Basic Operation

Check This First

Outdoor Unit

Models:

- 1U09EH2VHE
- 1U12EH2VHE
- 1U18EH2VHE

3-minutes of time delay from the call for heating or cooling

Line voltage available at:

1. TERMINAL STRIP - 1(N) & 2 (L)
2. AC-L & AC-N at the PCB - CN2 & CN1
3. AC-L OUT & AC-N OUT at the PCB - CN8 & CN9
4. AC-L & AC-N at the IPM - CN8 & CN9 (9K) / CN1 & CN2 (12K/18K)

- 1 (N) and 3 (C): 0-80 VAC fluctuating
- 2 (L) and 3 (C): 0-140 VAC fluctuating

310+ VDC available at:

1. P & N at the IPM - CN1 & CN5 (9K) / CN8 & CN9 (12K/18K)
2. P & N at the PCB - CN24 & CN26

Module COM 5-G-15 VDC available at:

1. CN23 at the PCB
2. CN11 at the IPM

Module power 5-G-15 VDC available at:

1. CN22 AT THE PCB
2. CN10 AT THE IPM

Wiring Diagram Reference

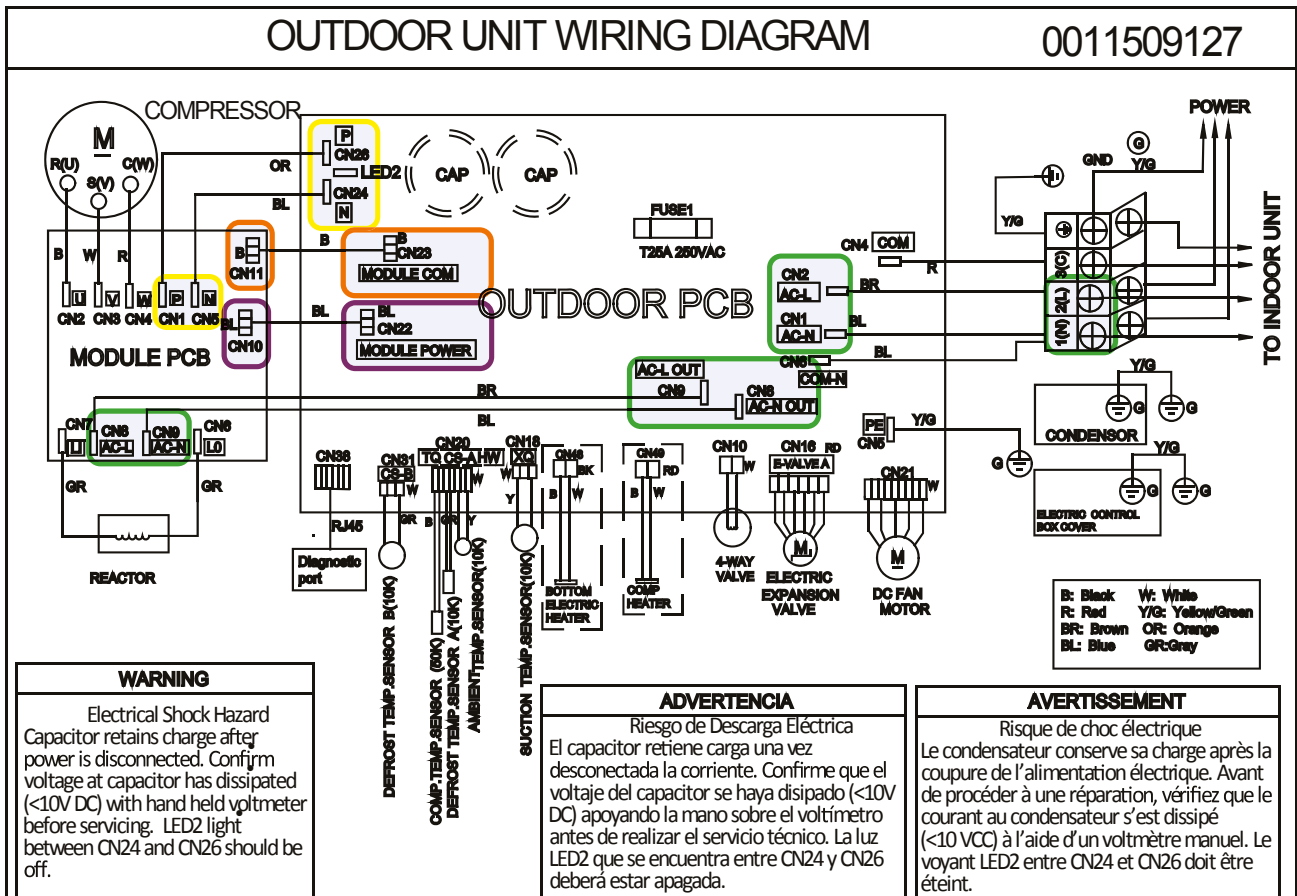

Troubleshooting

Check This First

Indoor Unit

Models:

AW09EH2VHD/ASYW09URDWD
 AW12EH2VHD/ASYW12URDWD
 AW18EH2VHD/ASYW18URDWD

See reverse side for wiring diagram and relevant color-coded test positions.

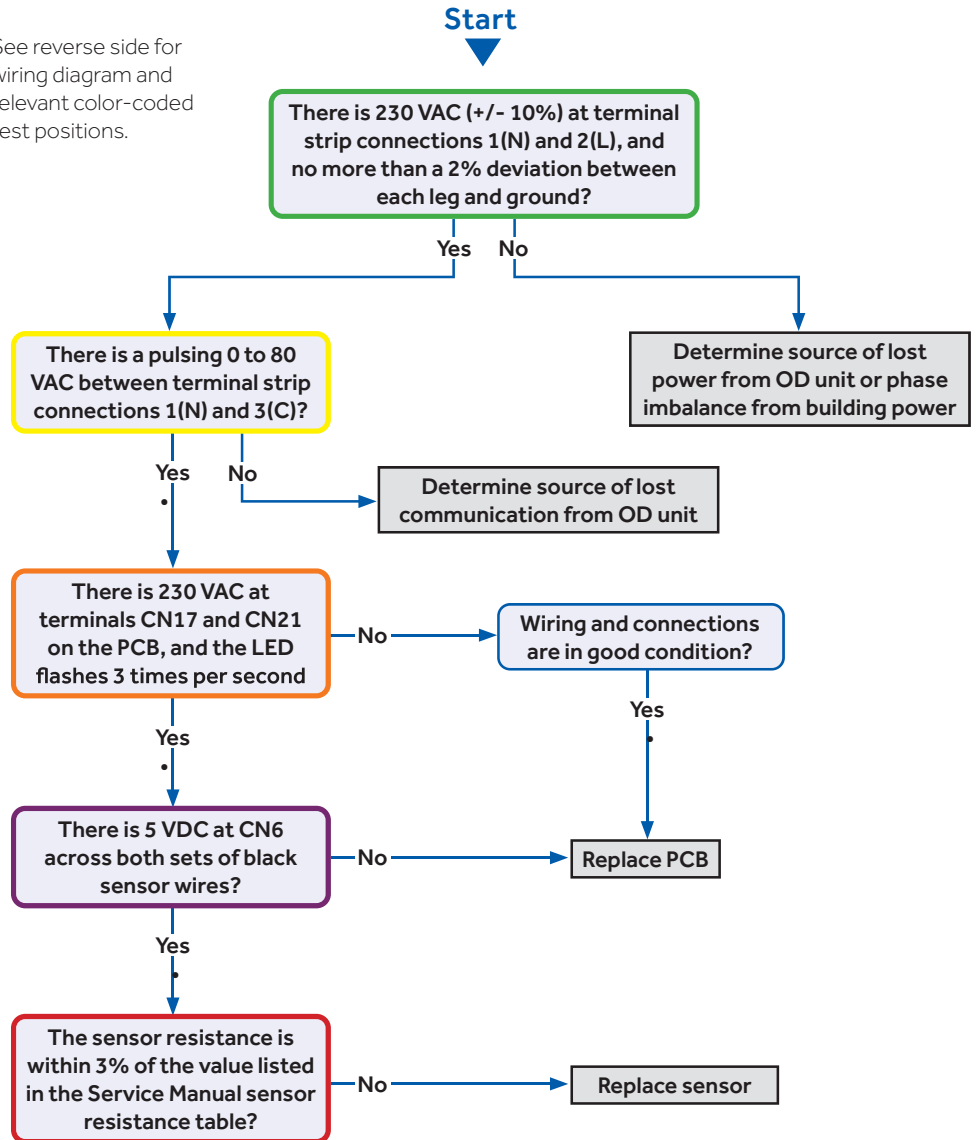

Troubleshooting

Check This First - Indoor Unit

Wiring Diagram Reference

Sensor Resistance Table

°F	°C	Normal (KΩ)		
		10K SENSORS	23K SENSORS	50K SENSORS
-0.4	-18	75.44	235.90	5494.21
5.0	-15	64.30	196.61	4558.19
10.4	-12	54.99	164.40	3795.39
14.0	-10	49.62	146.15	3365.73
21.2	-6	40.58	115.95	2658.81
24.8	-4	36.77	103.46	2368.32
32.0	0	30.30	82.69	1887.00
35.6	2	27.55	74.07	1687.81
41.0	5	23.95	62.94	1431.28
44.6	7	21.84	56.57	1284.36
50.0	10	19.06	48.31	1094.32
55.4	13	16.68	41.40	934.94
59.0	15	15.28	37.41	843.05
64.4	18	13.42	32.22	723.41
69.8	21	11.81	27.83	622.32
75.2	24	10.42	24.11	536.65
77.0	25	10.00	23.00	511.08
80.6	27	9.21	20.95	464.05
86.0	30	8.16	18.25	402.24
89.6	32	7.54	16.67	366.13
95.0	35	6.70	14.59	318.52
100.4	38	5.97	12.79	277.70

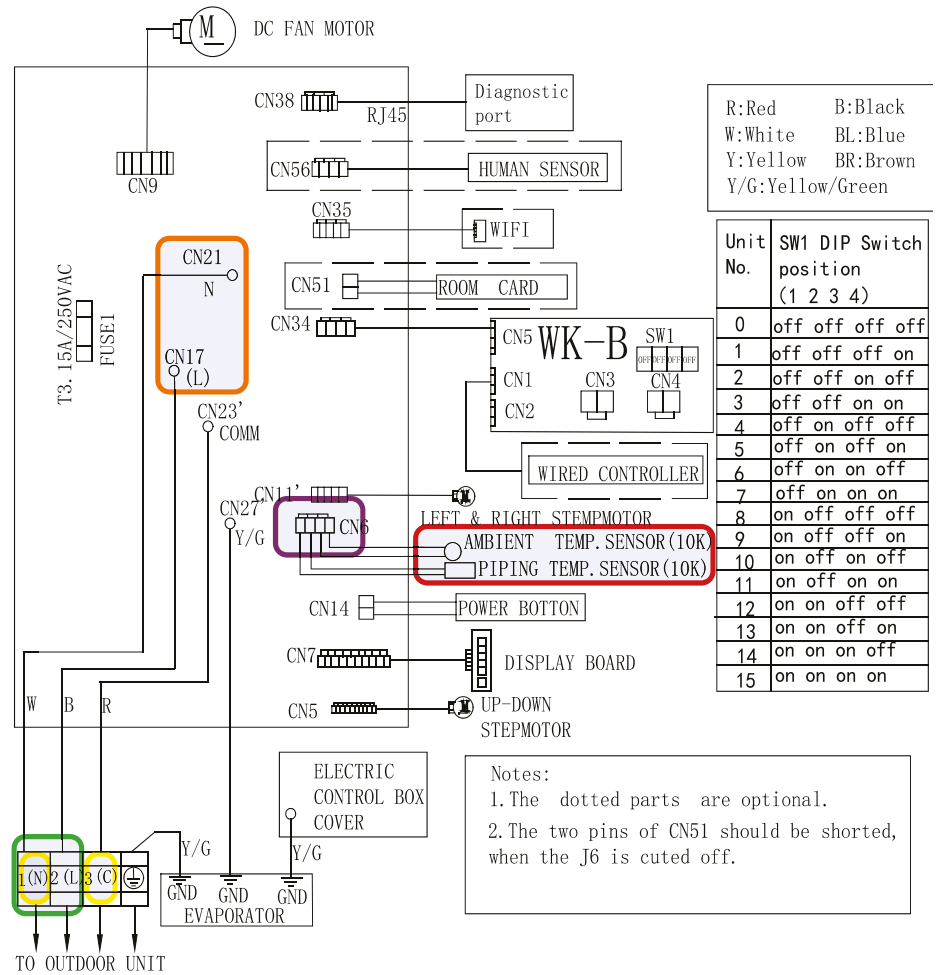

Model selection:
 09K model-23 code - BM1 - 1 off 2 off
 12K model-26 code - BM1 - 1 off 2 on
 18K model-33 code - BM1 - 1 on 2 off

Notes: Before replacing the board, it is necessary to ensure that the machine is matched with the board code

Troubleshooting

Error Code (Indoor/Outdoor)

F1/LED1: 2 Flash

IPM Power Module Fail
(IPM power module protection)

Complete the "Check This First" Flow Chart before continuing.

Models:

AW09EH2VHD/ASYW09URDWD
AW12EH2VHD/ASYW12URDWD
AW18EH2VHD/ASYW18URDWD

1U09EH2VHE/ASH109URDSE
1U12EH2VHE/ASH112URDSE
1U18EH2VHE/ASH118URDSE

See reverse side for wiring diagram and relevant color-coded test positions.

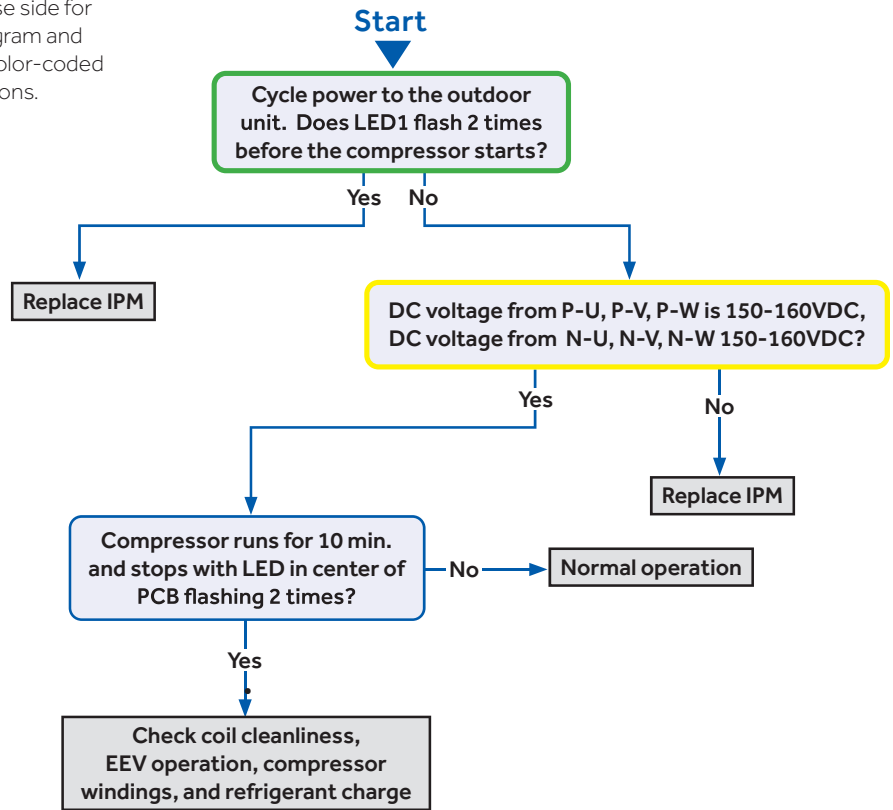

Troubleshooting

Error Code: F1/LED1: 2 Flash

Wiring Diagram Reference

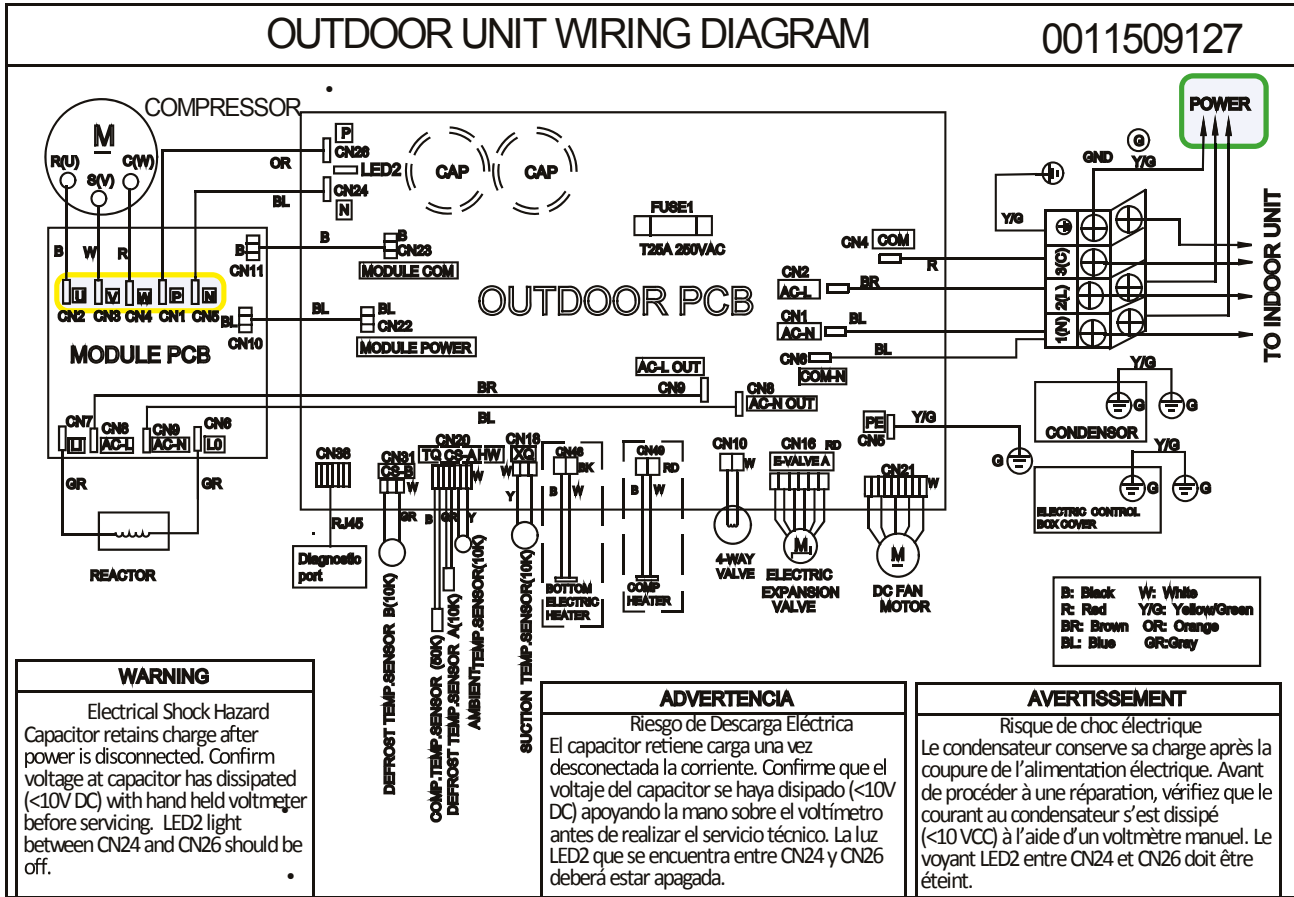

EEV Resistance Values

EEV (6-pin, 5 wire)

	White	Yellow	Orange	Blue	X	Red
White	-	92 Ω	92 Ω	92 Ω	-	46 Ω
Yellow	-	-	92 Ω	92 Ω	-	46 Ω
Orange	-	-	-	92 Ω	-	46 Ω
Blue	-	-	-	-	-	46 Ω
X	-	-	-	-	-	-
Red	-	-	-	-	-	-

EEV (6-pin, 6 wire)

	White	Yellow	Orange	Blue	Brown	Red
White	-	OL	92 Ω	OL	46 Ω	OL
Yellow	-	-	OL	92 Ω	OL	46 Ω
Orange	-	-	-	OL	46 Ω	OL
Blue	-	-	-	-	OL	46 Ω
Brown	-	-	-	-	-	OL
Red	-	-	-	-	-	-

Troubleshooting

Error Code (Indoor/Outdoor)

F2/LED1: 24 Flash

Overcurrent of the Compressor

Complete the "Check This First" Flow Chart before continuing.

Models:

AW09EH2VHD/ASYW09URDWD
 AW12EH2VHD/ASYW12URDWD
 AW18EH2VHD/ASYW18URDWD

1U09EH2VHE/ASH109URDSE
 1U12EH2VHE/ASH112URDSE
 1U18EH2VHE/ASH118URDSE

See reverse side for wiring diagram and relevant color-coded test positions.

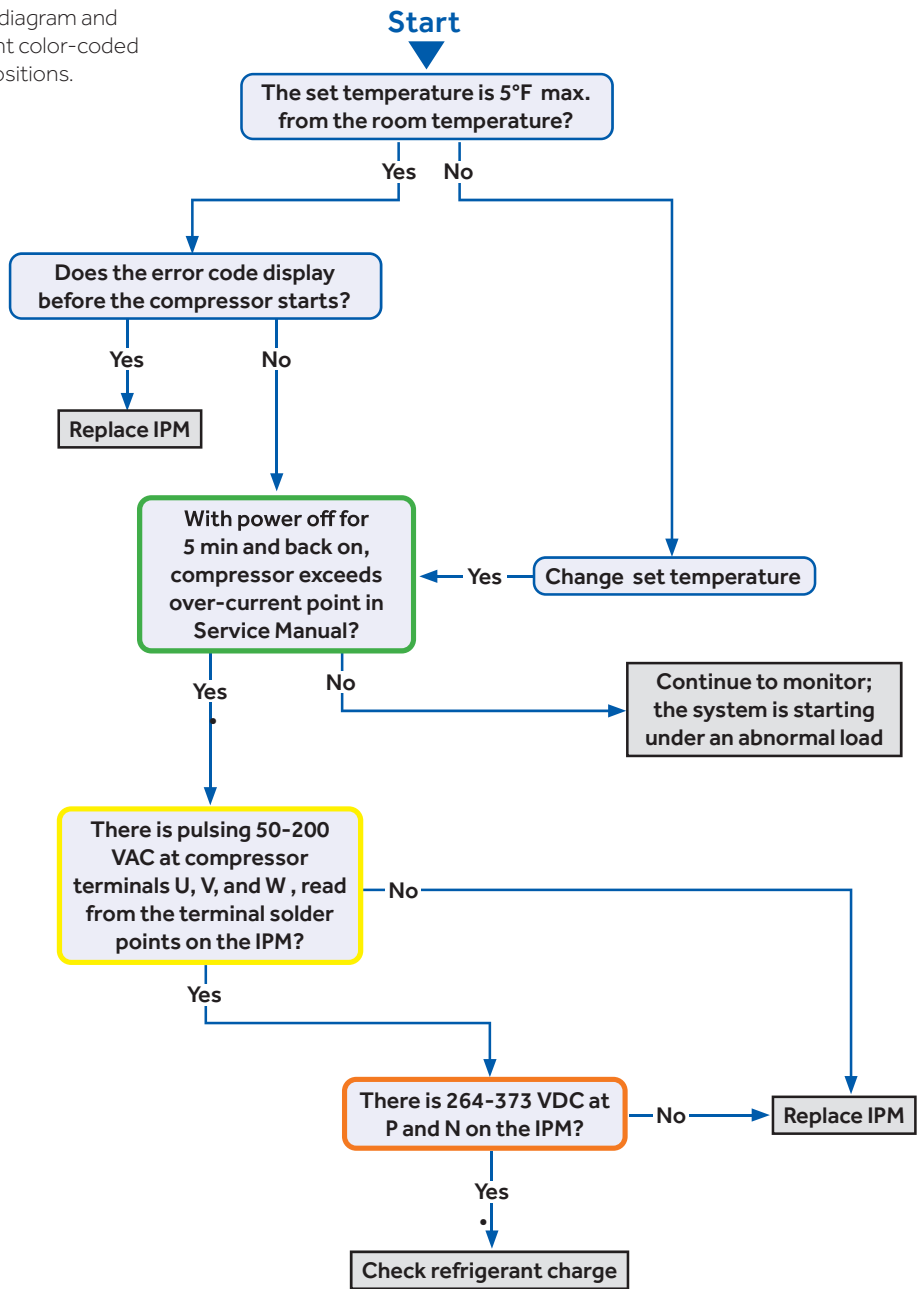

Troubleshooting

Error Code: F2/LED1: 24 Flash

Wiring Diagram Reference

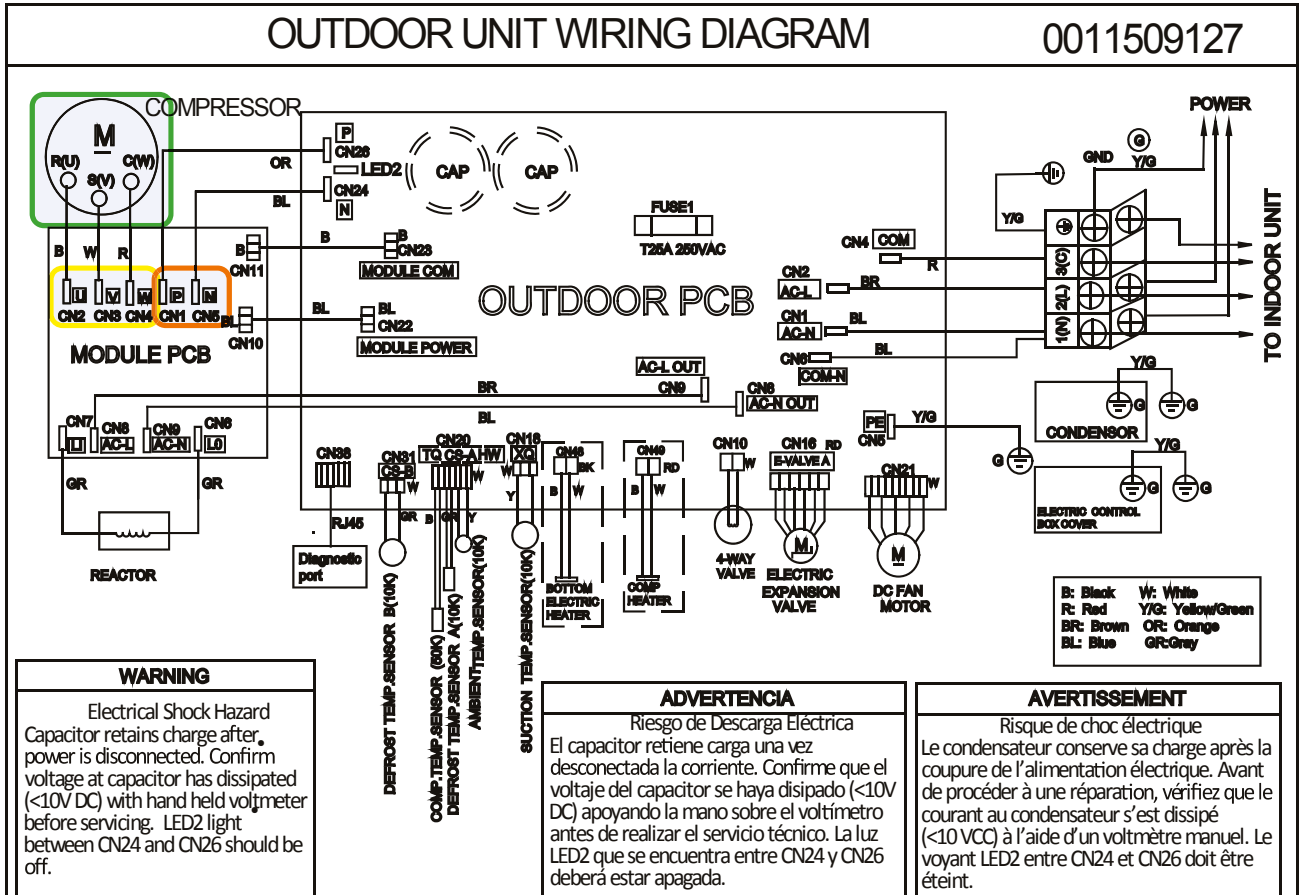

Troubleshooting

Error Code (Indoor/Outdoor)

F3/LED1: 4 Flash

Communication Fault Between IPM and Outdoor PCB

Complete the "Check This First" Flow Chart before continuing.

Models:

AW09EH2VHD/ASYW09URDWD
 AW12EH2VHD/ASYW12URDWD
 AW18EH2VHD/ASYW18URDWD

1U09EH2VHE/ASH109URDSE
 1U12EH2VHE/ASH112URDSE
 1U18EH2VHE/ASH118URDSE

See reverse side for wiring diagram and relevant color-coded test positions.

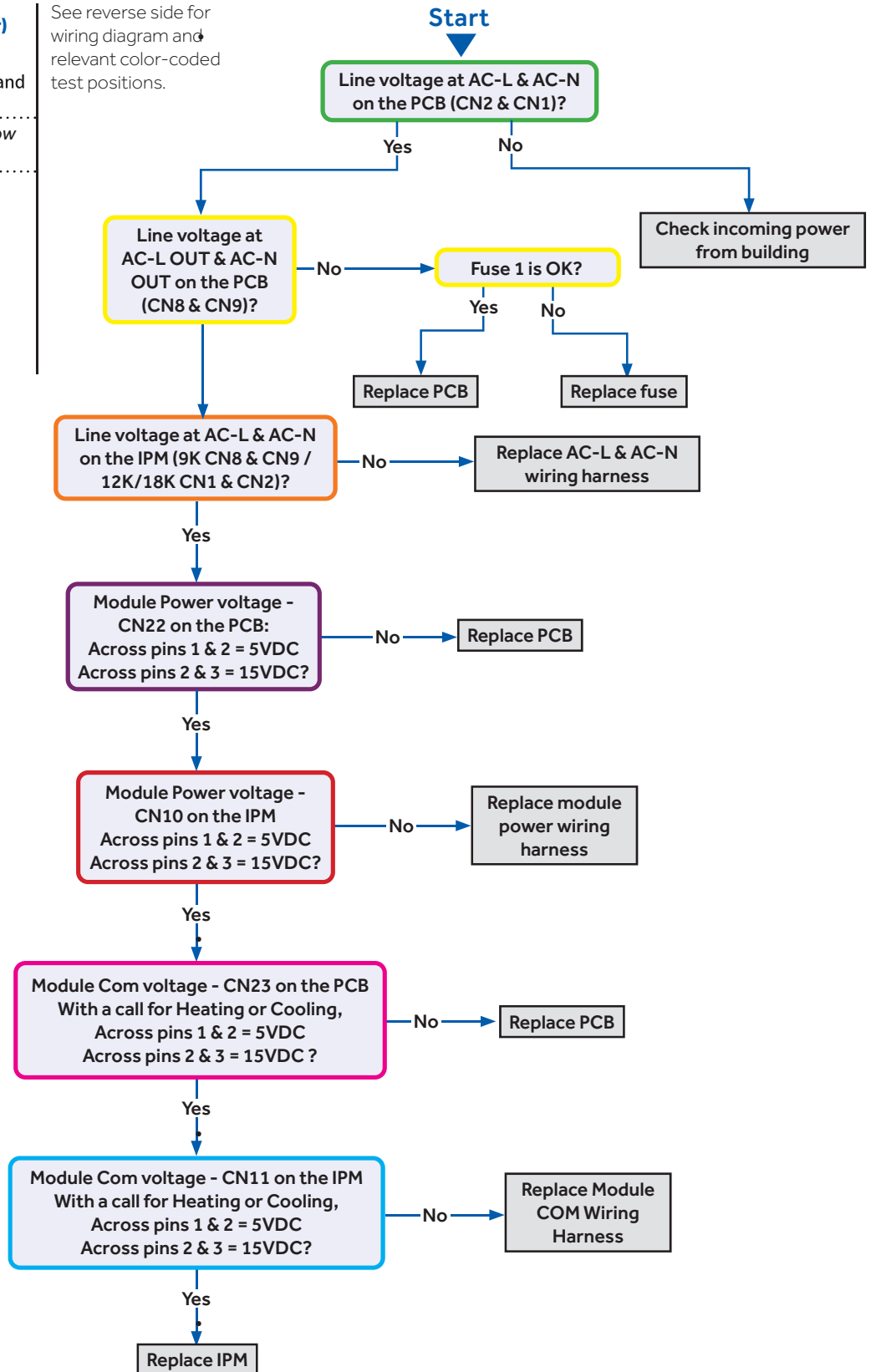

Troubleshooting

Error Code: F3/LED1: 4 Flash

Wiring Diagram Reference

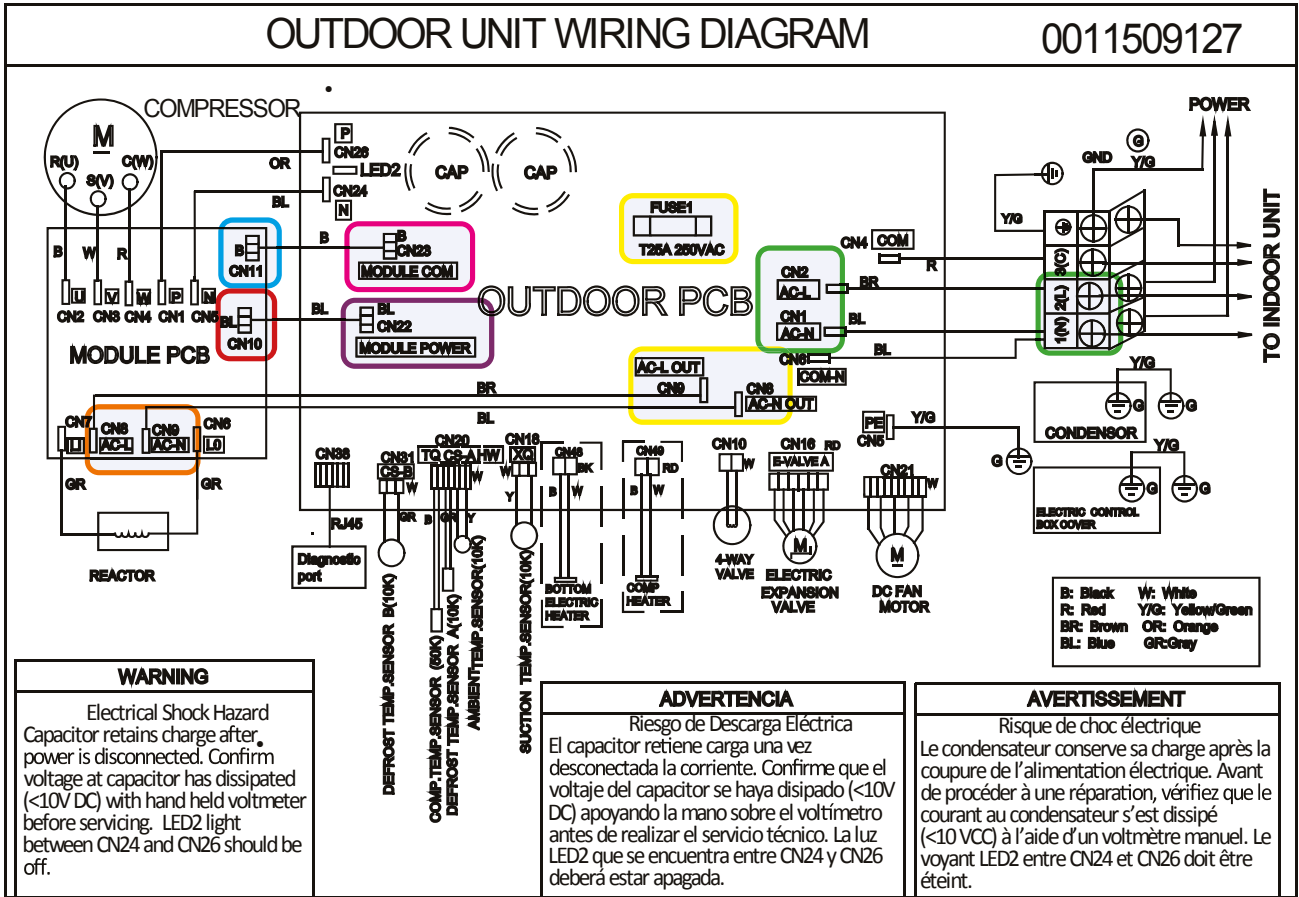

Troubleshooting

Error Code (Indoor/Outdoor)

F4/LED1: 8 Flash

Overheat Protection For Discharge Temperature

Complete the "Check This First" Flow Chart before continuing.

Models:

AW09EH2VHD/ASYW09URDWD
 AW12EH2VHD/ASYW12URDWD
 AW18EH2VHD/ASYW18URDWD

1U09EH2VHE/ASH109URDSE
 1U12EH2VHE/ASH112URDSE
 1U18EH2VHE/ASH118URDSE

See reverse side for wiring diagram and relevant color-coded test positions.

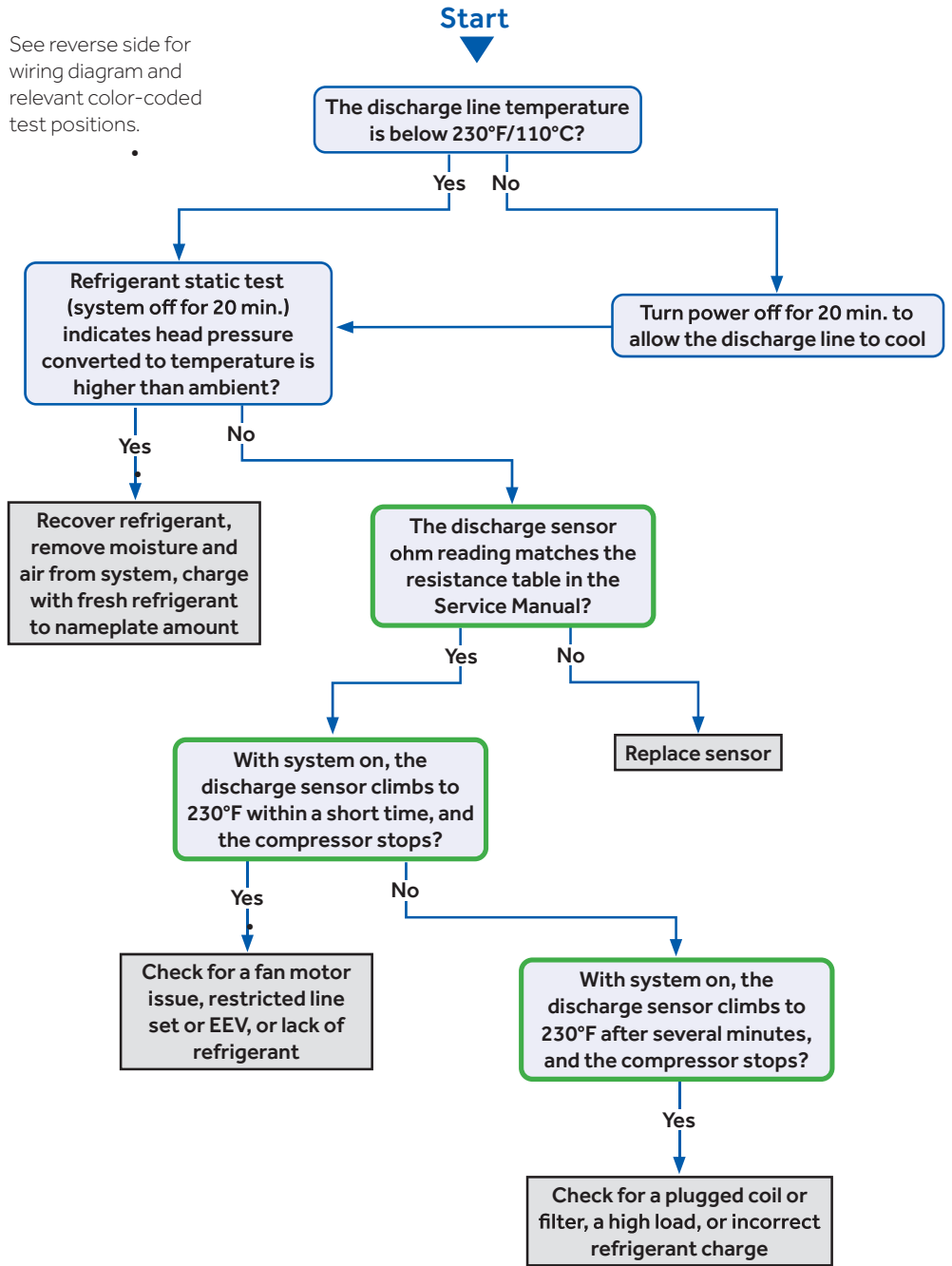

Troubleshooting

Error Code: F4/LED1: 8 Flash

Wiring Diagram Reference

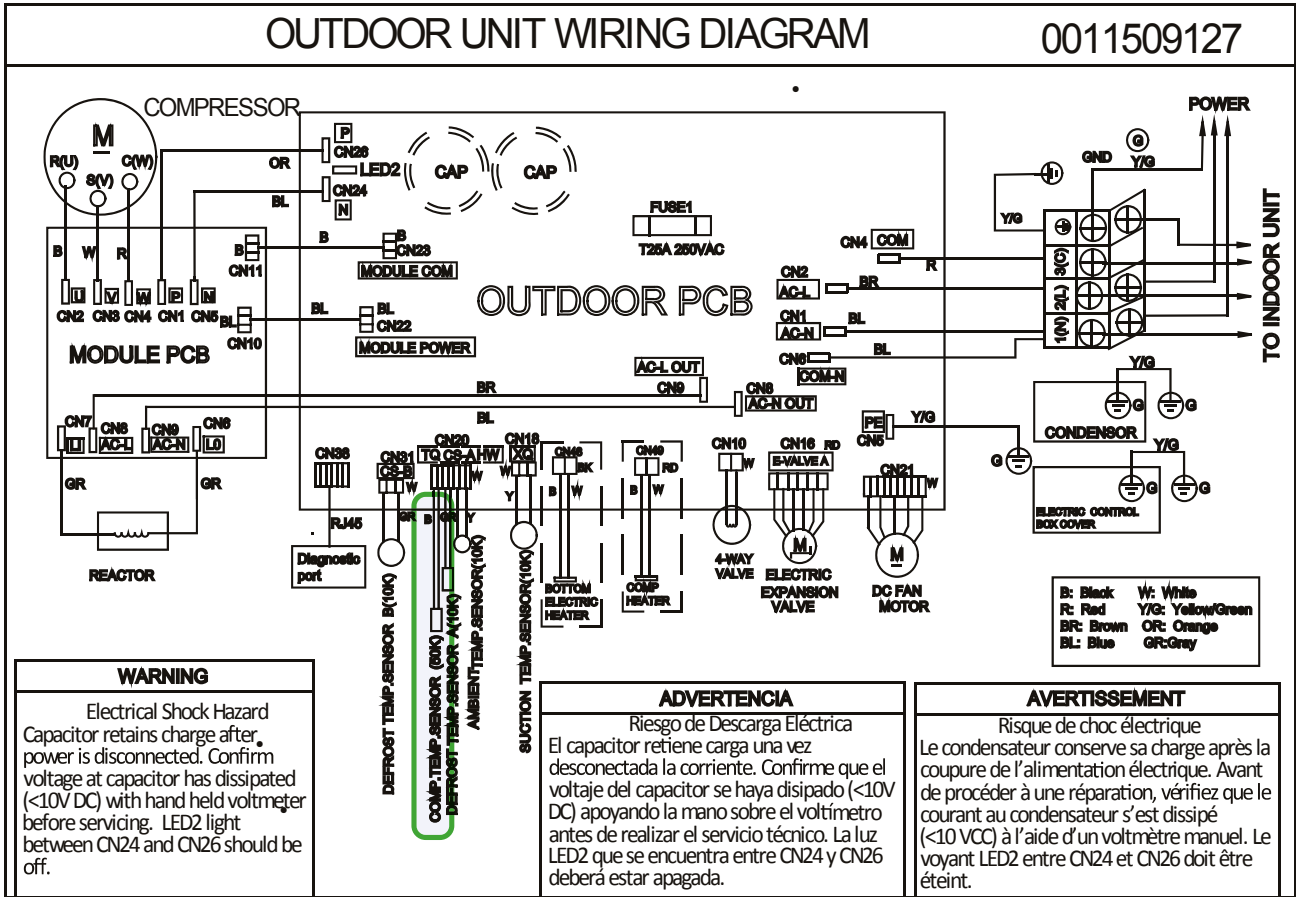

EEV Resistance Values

EEV (6-pin, 5 wire)

	White	Yellow	Orange	Blue	Red
White	-	92 Ω	92 Ω	92 Ω	46 Ω
Yellow	-	-	92 Ω	92 Ω	46 Ω
Orange	-	-	-	92 Ω	46 Ω
Blue	-	-	-	-	46 Ω
Red	-	-	-	-	-

EEV (6-pin, 6 wire)

	White	Yellow	Orange	Blue	Brown	Red
White	-	0L	92 Ω	0L	46 Ω	0L
Yellow	-	-	0L	92 Ω	0L	46 Ω
Orange	-	-	-	0L	46 Ω	0L
Blue	-	-	-	-	0L	46 Ω
Brown	-	-	-	-	-	0L
Red	-	-	-	-	-	-

Troubleshooting

Error Codes (Indoor/Outdoor)

F6/LED1: 12 Flash
Ambient Temperature Sensor Failure

F7/LED1: 11 Flash
Suction Temperature Sensor Failure

F21/LED1: 10 Flash
Defrost Temperature Sensor Failure

F25/LED1: 13 Flash
Discharge Temperature Sensor Failure

E1/LED1: No Flash
Room Temperature Sensor Failure

E2/LED1: No Flash
Indoor Coil Temperature Sensor Failure

Complete the "Check This First" Flow Chart before continuing.

Models:

AW09EH2VHD/ASYW09URDWD
AW12EH2VHD/ASYW12URDWD
AW18EH2VHD/ASYW18URDWD

1U09EH2VHE/ASH109URDSE
1U12EH2VHE/ASH112URDSE
1U18EH2VHE/ASH118URDSE

See reverse side for wiring diagram, relevant color-coded test positions, and sensor resistance values.

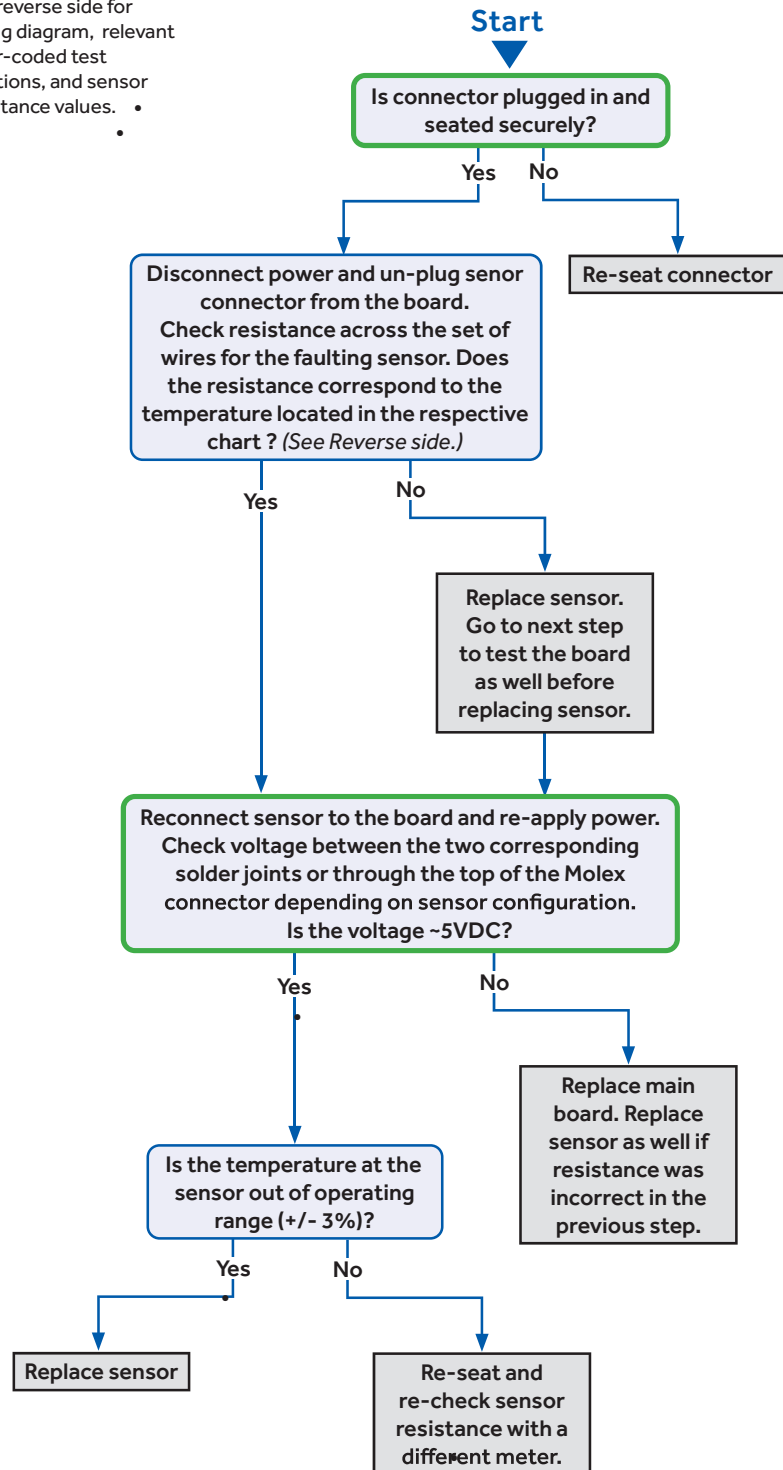

Troubleshooting

Error Code: F6/LED1: 12 Flash, F7/LED1: 11 Flash, F21/LED1: 10 Flash, F25/LED1: 13 Flash, E1/LED1: No Flash, E2/LED1: No Flash

Wiring Diagram Reference

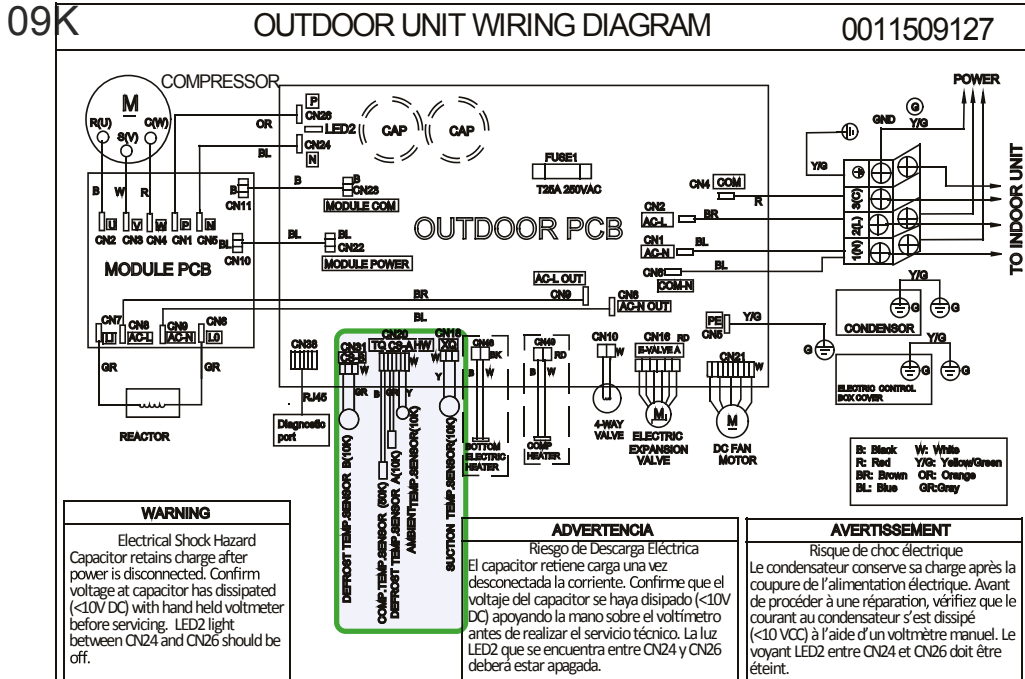

12K-18K

Sensor Resistance Table

°F	°C	Normal (KΩ)		
		10K SENSORS	23K SENSORS	50K SENSORS
-0.4	-18	75.44	235.90	5494.21
5.0	-15	64.30	196.61	4558.19
10.4	-12	54.99	164.40	3795.39
14.0	-10	49.62	146.15	3365.73
21.2	-6	40.58	115.95	2658.81
24.8	-4	36.77	103.46	2368.32
32.0	0	30.30	82.69	1887.00
35.6	2	27.55	74.07	1687.81
41.0	5	23.95	62.94	1431.28
44.6	7	21.84	56.57	1284.36
50.0	10	19.06	48.31	1094.32
55.4	13	16.68	41.40	934.94
59.0	15	15.28	37.41	843.05
64.4	18	13.42	32.22	723.41
69.8	21	11.81	27.83	622.32
75.2	24	10.42	24.11	536.65
77.0	25	10.00	23.00	511.08
80.6	27	9.21	20.95	464.05
86.0	30	8.16	18.25	402.24
89.6	32	7.54	16.67	366.13
95.0	35	6.70	14.59	318.52
100.4	38	5.97	12.79	277.70

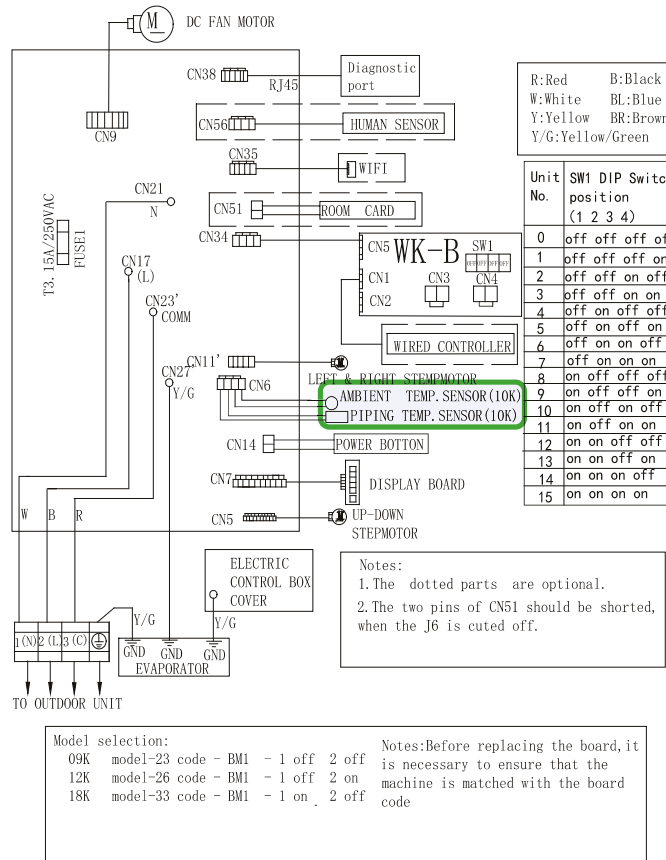

Troubleshooting

Error Code (Indoor/Outdoor)

F8/LED1: 9 Flash

Outdoor DC Fan Motor Fault

Complete the "Check This First" Flow Chart before continuing.

Models:

AW09EH2VHD/ASYW09URDWD
 AW12EH2VHD/ASYW12URDWD
 AW18EH2VHD/ASYW18URDWD

1U09EH2VHE/ASH109URDSE
 1U12EH2VHE/ASH112URDSE
 1U18EH2VHE/ASH118URDSE

See reverse side for wiring diagram and relevant color-coded test positions.

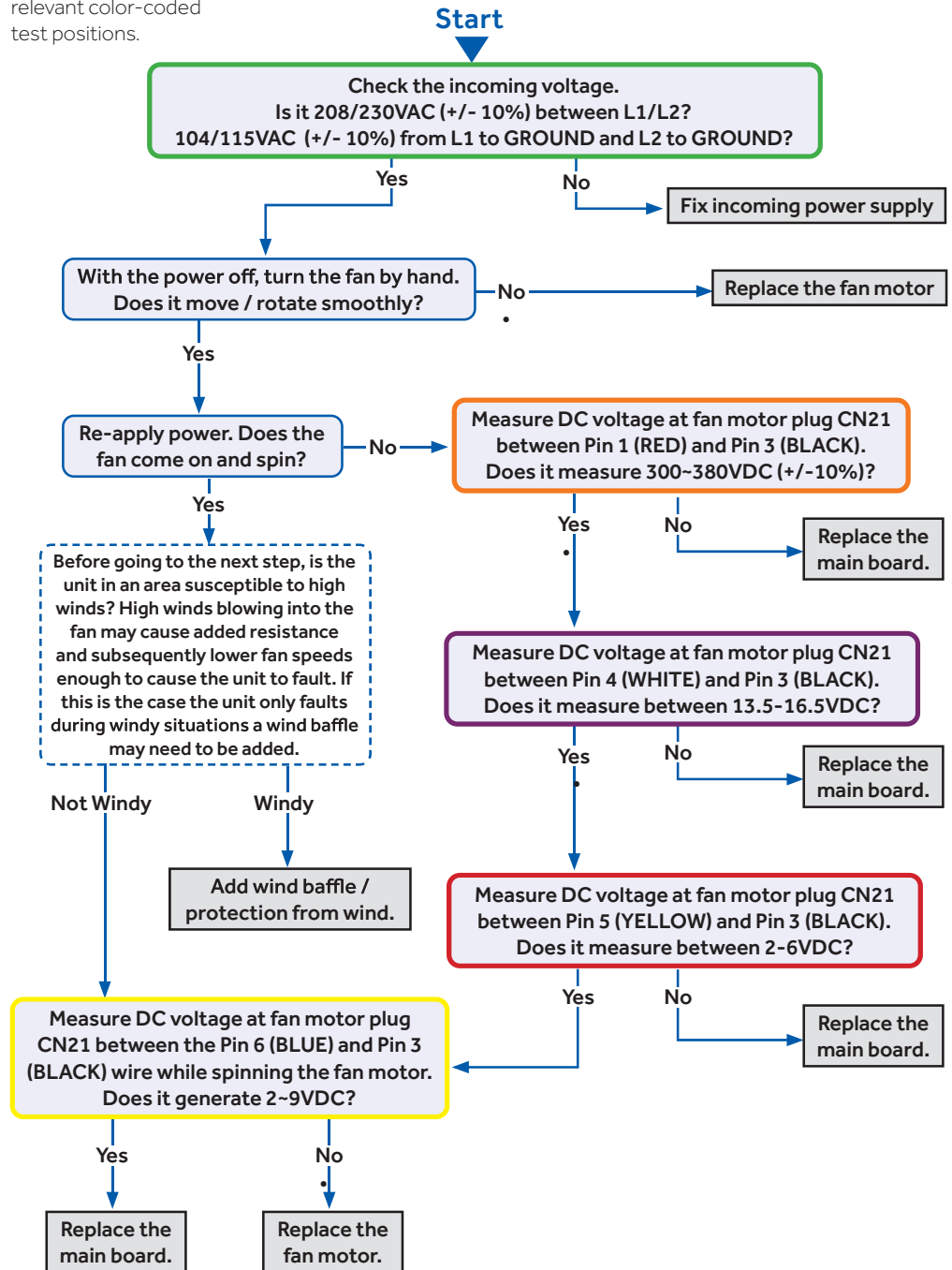

Troubleshooting

Error Code: F8/LED1: 9 Flash

Wiring Diagram Reference

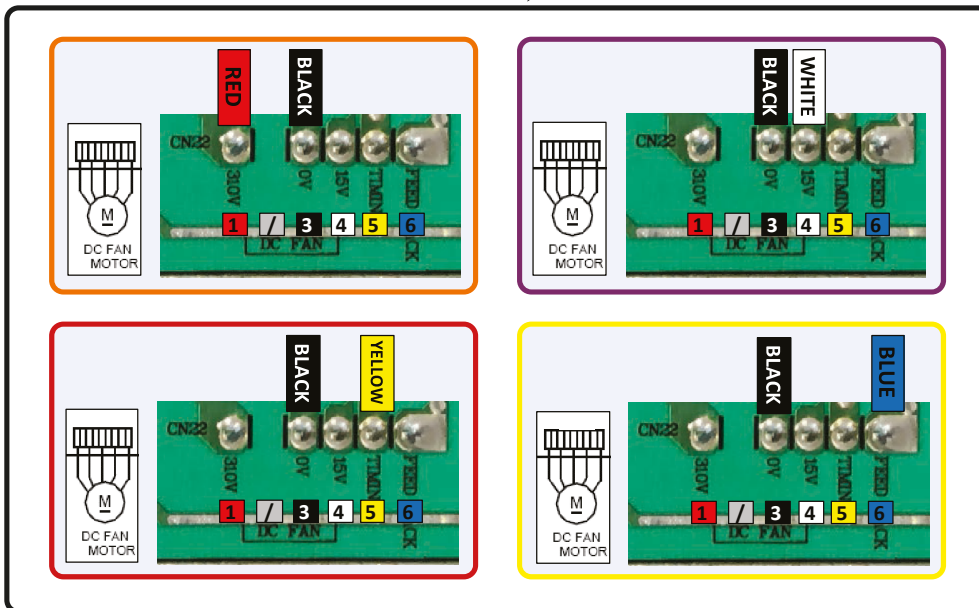
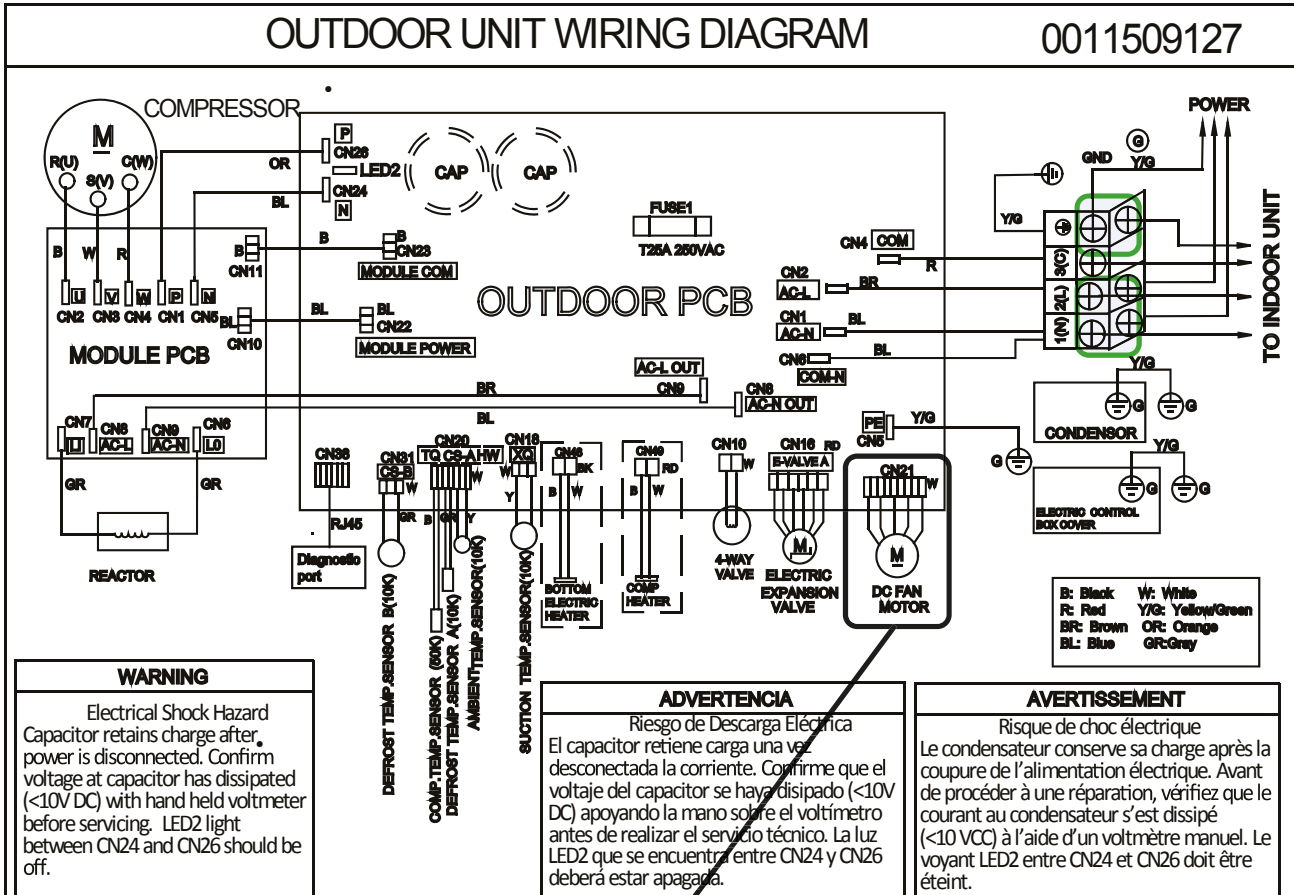

Troubleshooting

Error Code (Indoor/Outdoor)

F11/LED1: 18 Flash

Loss of Compressor Synchronization

Complete the "Check This First" Flow Chart before continuing.

Models:

AW09EH2VHD/ASYW09URDWD
 AW12EH2VHD/ASYW12URDWD
 AW18EH2VHD/ASYW18URDWD

1U09EH2VHE/ASH109URDSE
 1U12EH2VHE/ASH112URDSE
 1U18EH2VHE/ASH118URDSE

See reverse side for wiring diagram and relevant color-coded test positions.

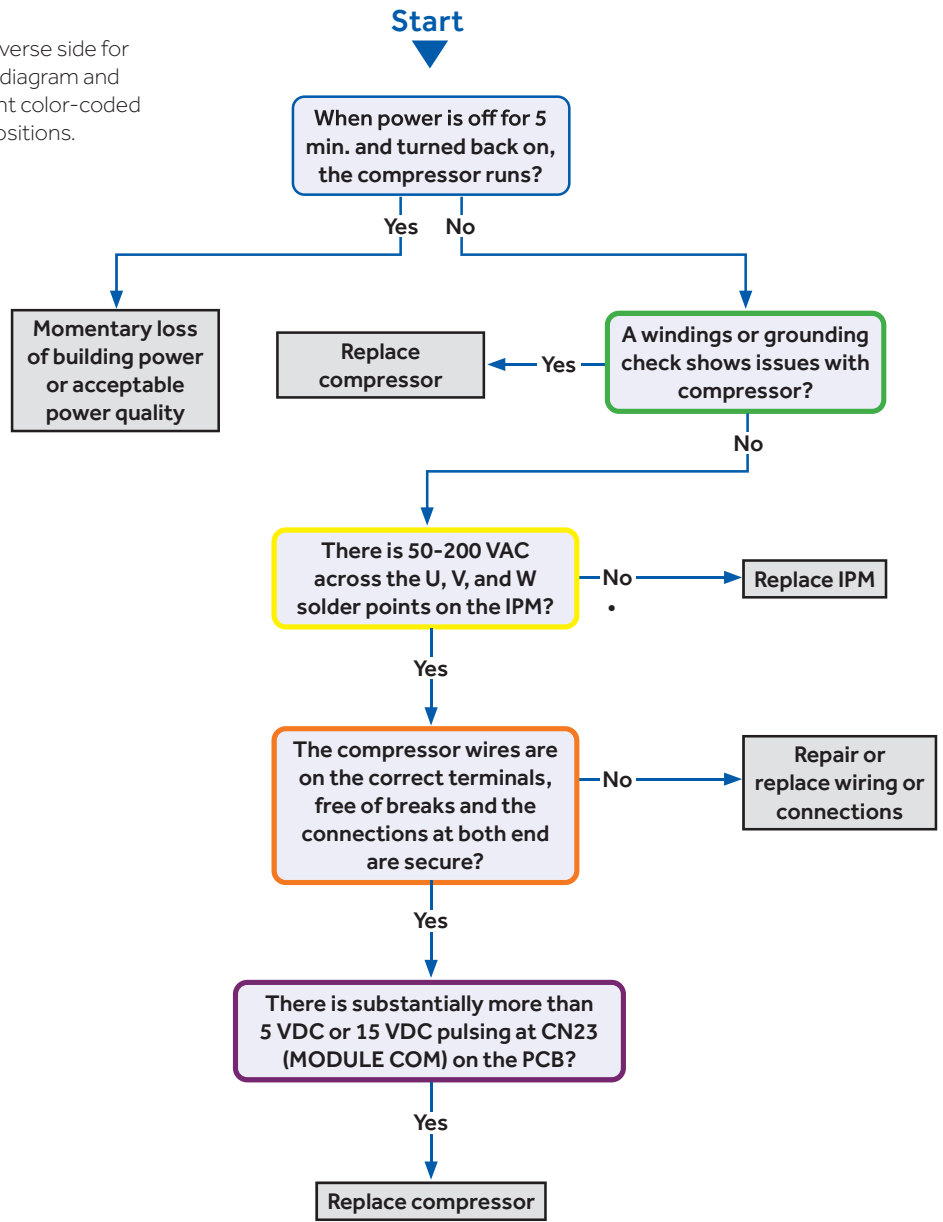

Troubleshooting

Error Code: F11/LED1: 18 Flash

Wiring Diagram Reference

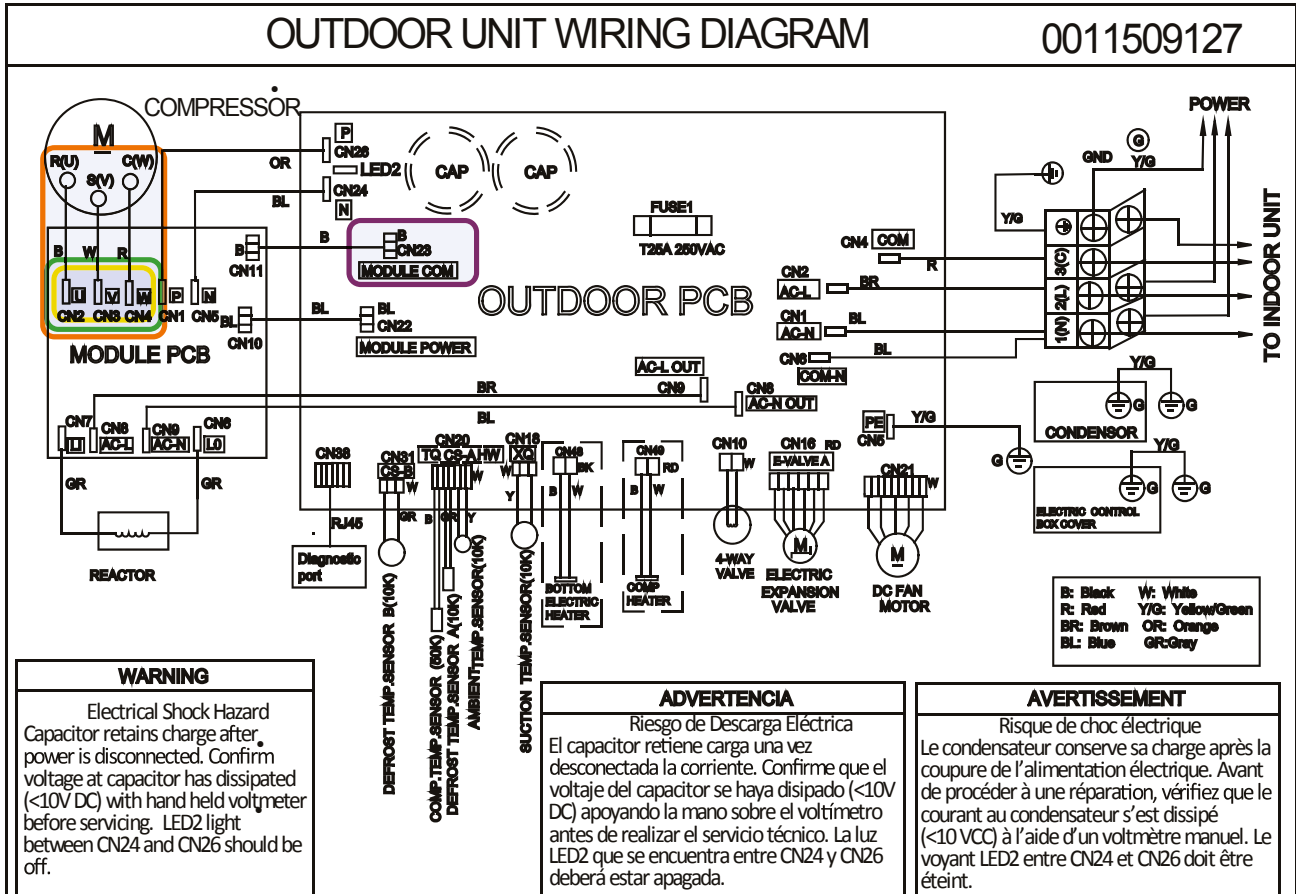

Troubleshooting

Error Code (Indoor/Outdoor)

F12/LED1: 1 Flash

EEPROM Error

Complete the "Check This First" Flow Chart before continuing.

Models:

AW09EH2VHD/ASYW09URDWD
AW12EH2VHD/ASYW12URDWD
AW18EH2VHD/ASYW18URDWD

1U09EH2VHE/ASH109URDSE
1U12EH2VHE/ASH112URDSE
1U18EH2VHE/ASH118URDSE

See reverse side for wiring diagram and relevant color-coded test positions.

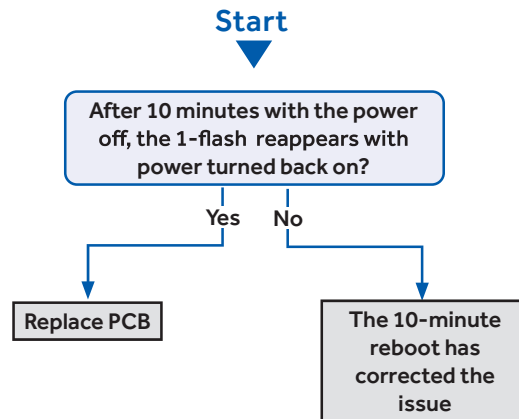

Wiring Diagram Reference

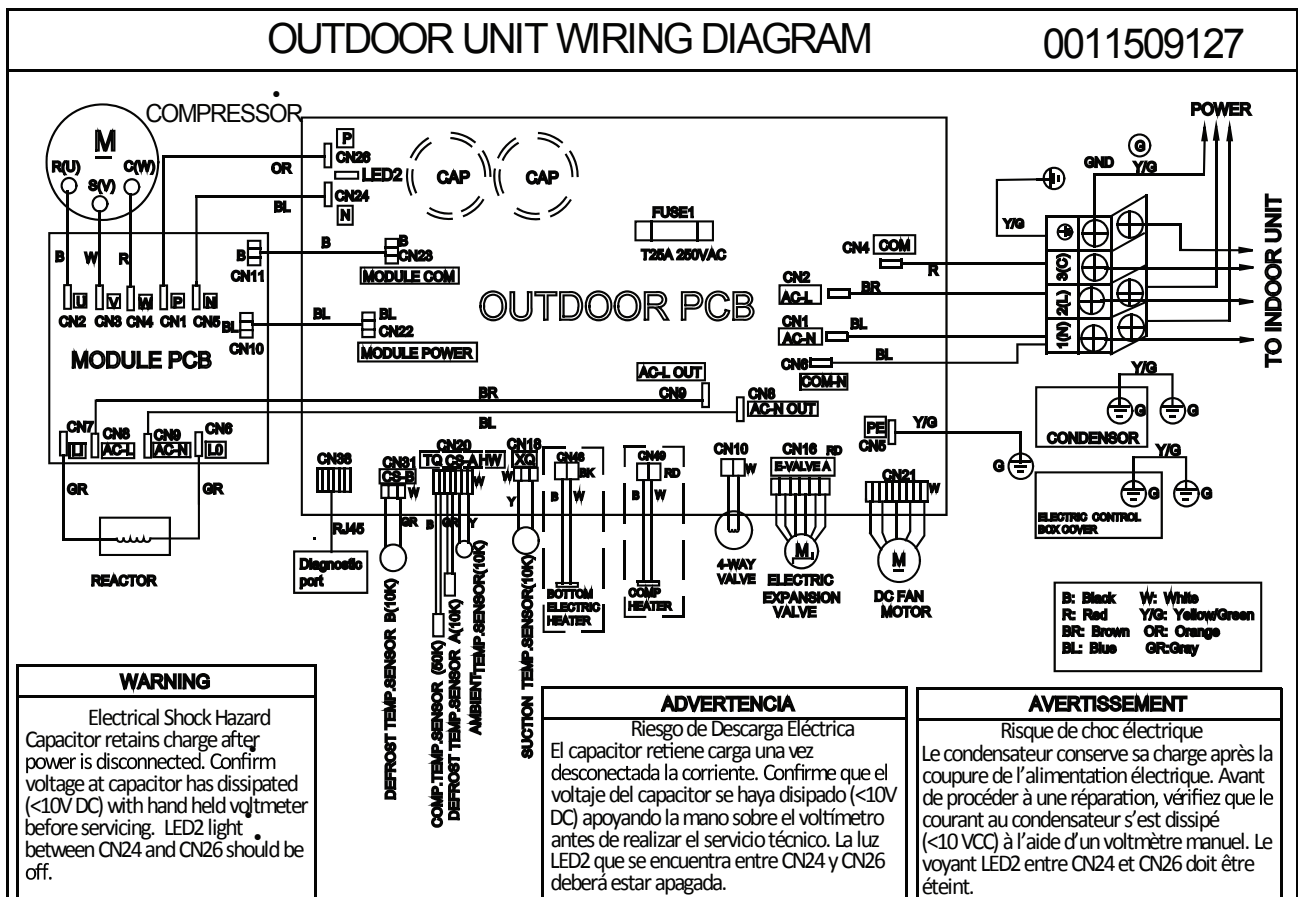

Troubleshooting

Error Code (Indoor/Outdoor)

E5/LED1: 22 Flash

Coil Frost Protection

Complete the "Check This First" Flow Chart before continuing.

Models:

AW09EH2VHD/ASYW09URDWD
 AW12EH2VHD/ASYW12URDWD
 AW18EH2VHD/ASYW18URDWD

1U09EH2VHE/ASH109URDSE
 1U12EH2VHE/ASH112URDSE
 1U18EH2VHE/ASH118URDSE

See reverse side for wiring diagram and relevant color-coded test positions.

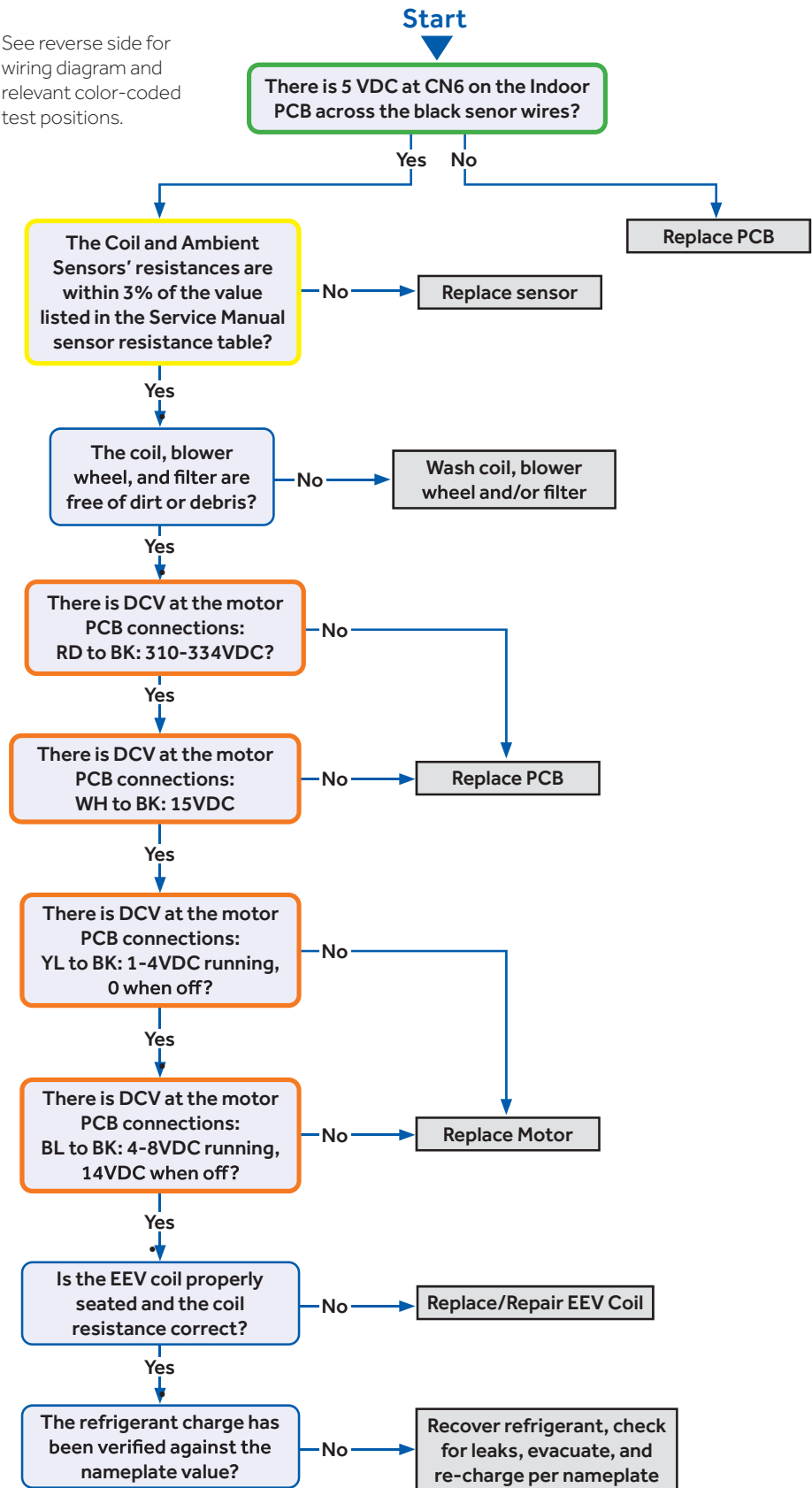

Troubleshooting

Error Code: E5/LED1: 22 Flash

Wiring Diagram Reference

Sensor Resistance Table

°F	°C	Normal (KΩ)		
		10K SENSORS	23K SENSORS	50K SENSORS
-0.4	-18	75.44	235.90	5494.21
5.0	-15	64.30	196.61	4558.19
10.4	-12	54.99	164.40	3795.39
14.0	-10	49.62	146.15	3365.73
21.2	-6	40.58	115.95	2658.81
24.8	-4	36.77	103.46	2368.32
32.0	0	30.30	82.69	1887.00
35.6	2	27.55	74.07	1687.81
41.0	5	23.95	62.94	1431.28
44.6	7	21.84	56.57	1284.36
50.0	10	19.06	48.31	1094.32
55.4	13	16.68	41.40	934.94
59.0	15	15.28	37.41	843.05
64.4	18	13.42	32.22	723.41
69.8	21	11.81	27.83	622.32
75.2	24	10.42	24.11	536.65
77.0	25	10.00	23.00	511.08
80.6	27	9.21	20.95	464.05
86.0	30	8.16	18.25	402.24
89.6	32	7.54	16.67	366.13
95.0	35	6.70	14.59	318.52
100.4	38	5.97	12.79	277.70

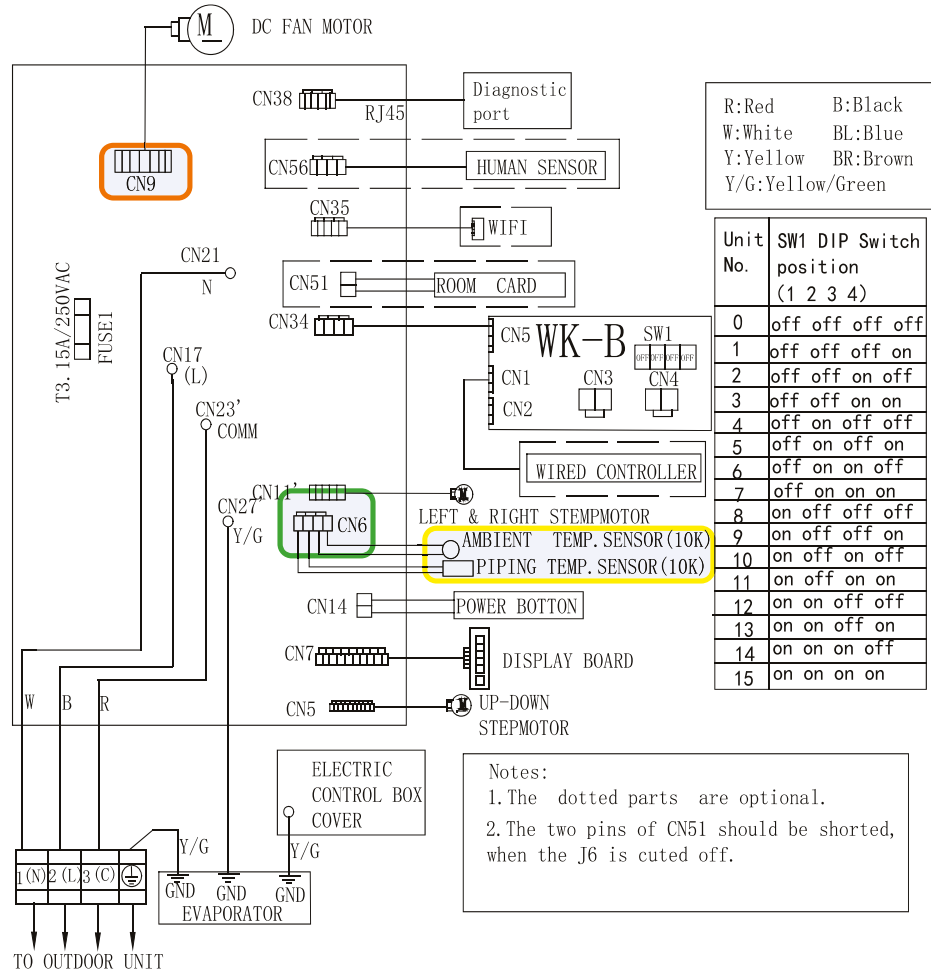

Model selection:

09K	model-23	code - BM1	- 1 off	2 off	Notes: Before replacing the board, it is necessary to ensure that the machine is matched with the board code
12K	model-26	code - BM1	- 1 off	2 on	
18K	model-33	code - BM1	- 1 on	2 off	

EEV Resistance Values

EEV (6-pin, 5 wire)

	White	Yellow	Orange	Blue		Red
White	-	92 Ω	92 Ω	92 Ω	-	46 Ω
Yellow	-	-	92 Ω	92 Ω	-	46 Ω
Orange	-	-	-	92 Ω	-	46 Ω
Blue	-	-	-	-	-	46 Ω
	-	-	-	-	-	-
Red	-	-	-	-	-	-

EEV (6-pin, 6 wire)

	White	Yellow	Orange	Blue	Brown	Red
White	-	0L	92 Ω	0L	46 Ω	0L
Yellow	-	-	0L	92 Ω	0L	46 Ω
Orange	-	-	-	0L	46 Ω	0L
Blue	-	-	-	-	0L	46 Ω
Brown	-	-	-	-	-	0L
Red	-	-	-	-	-	-

Error Code (Indoor/Outdoor)

E7/LED1: 15 Flash ID and OD Loss of Communication

Complete the "Check This First" Flow Chart for both ID and OD units before continuing.

Models:

AW09EH2VHD/ASYW09URDWD
AW12EH2VHD/ASYW12URDWD
AW18EH2VHD/ASYW18URDWD

1U09EH2VHE/ASH109URDSE
1U12EH2VHE/ASH112URDSE
1U18EH2VHE/ASH118URDSE

See reverse side for wiring diagram and relevant color-coded test positions.

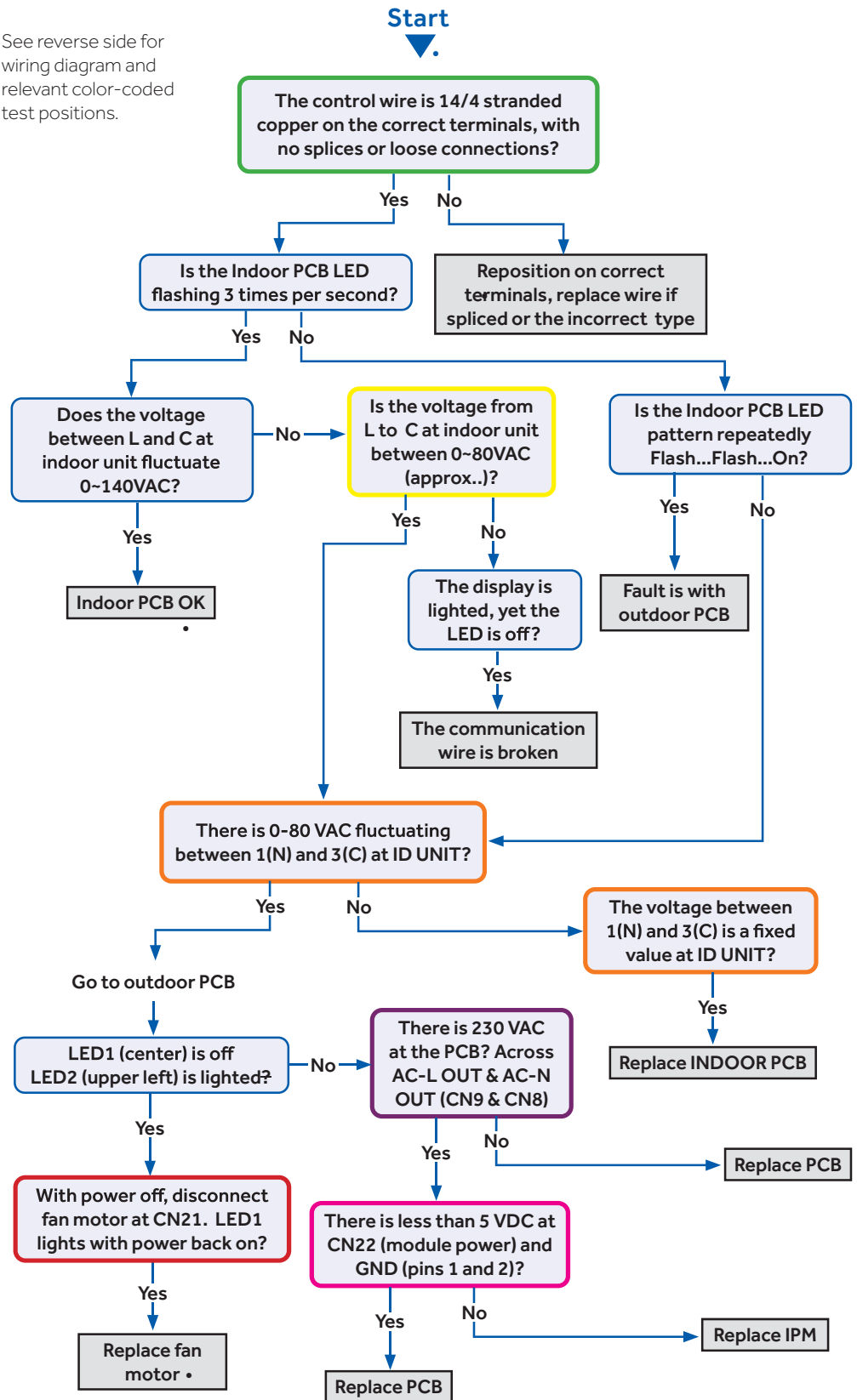

Troubleshooting

Error Code: E7/LED1: 15 Flash

Wiring Diagram Reference

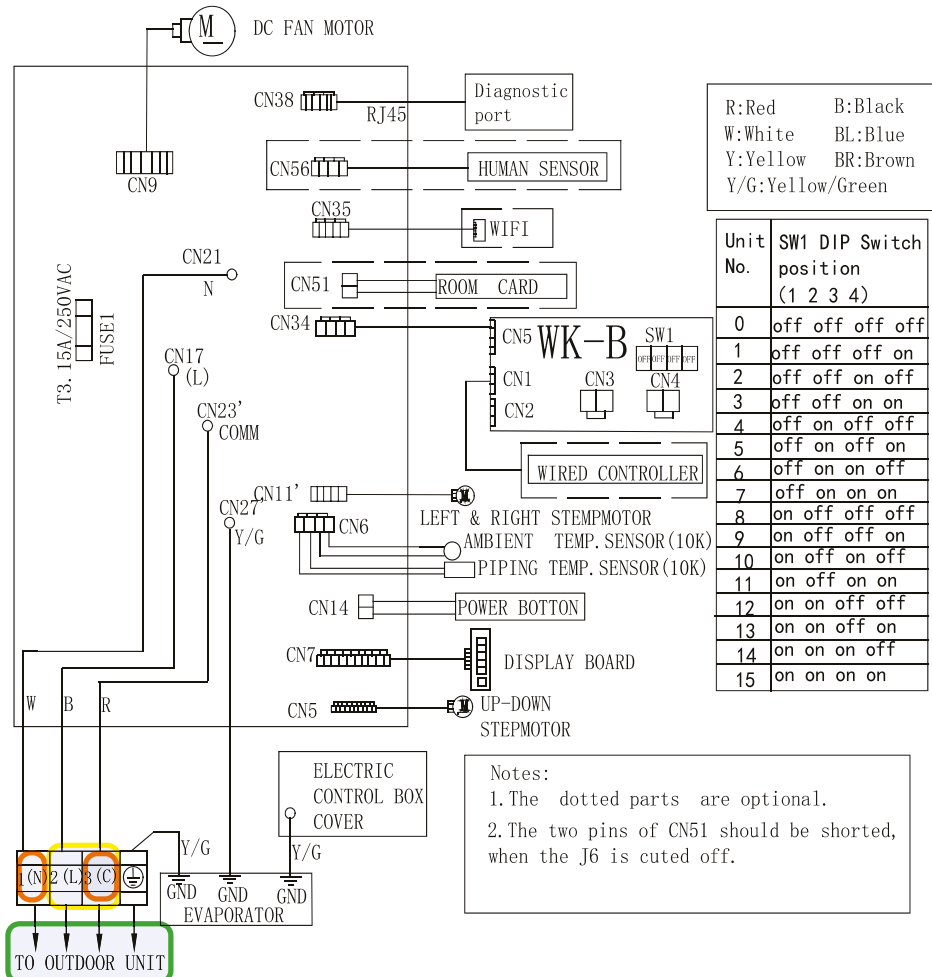

Model selection:
 09K model-23 code - BM1 - 1 off 2 off
 12K model-26 code - BM1 - 1 off 2 on
 18K model-33 code - BM1 - 1 on 2 off

Notes: Before replacing the board, it is necessary to ensure that the machine is matched with the board code

Troubleshooting

Error Code: E7/LED1: 15 Flash

Wiring Diagram Reference

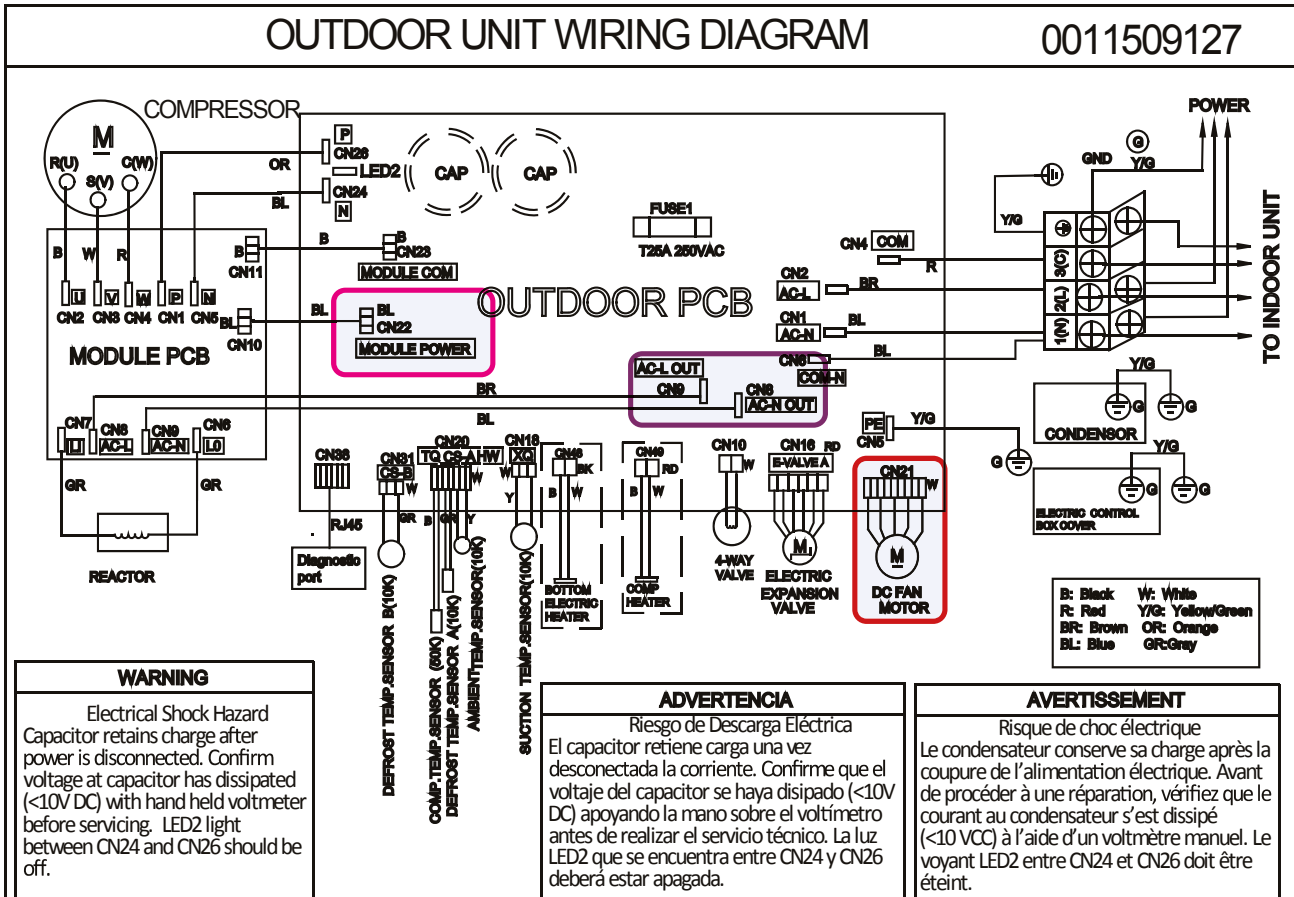

Troubleshooting

Error Code (Indoor)

E14

Indoor Fan Motor Failure

Complete the "Check This First" Flow Chart before continuing.

Models:

AW09EH2VHD/ASYW09URDWD
 AW12EH2VHD/ASYW12URDWD
 AW18EH2VHD/ASYW18URDWD

See reverse side for wiring diagram and relevant color-coded test positions.

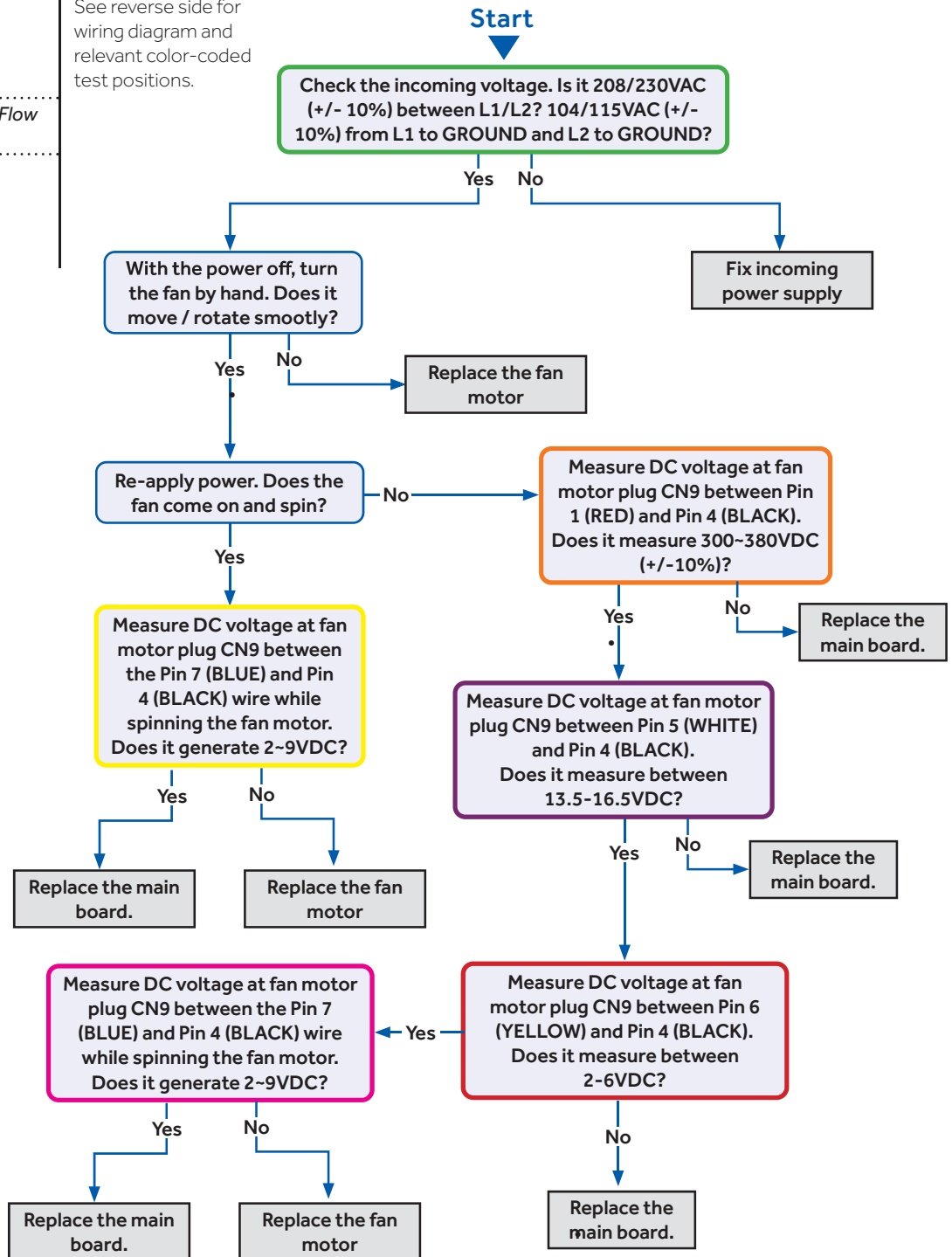

Troubleshooting

Error Code: E14

Wiring Diagram Reference

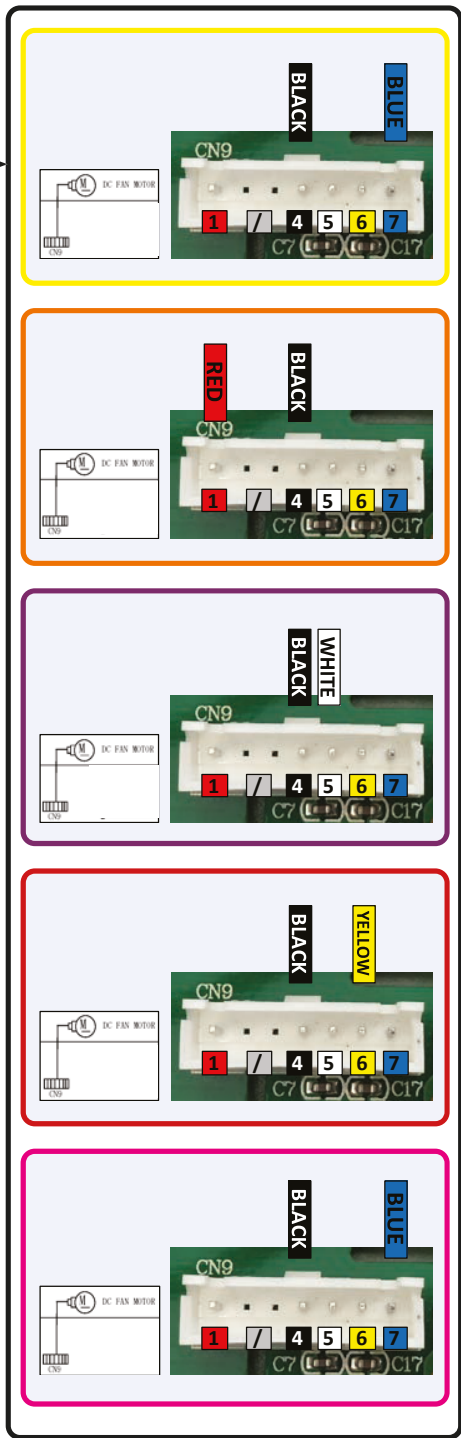
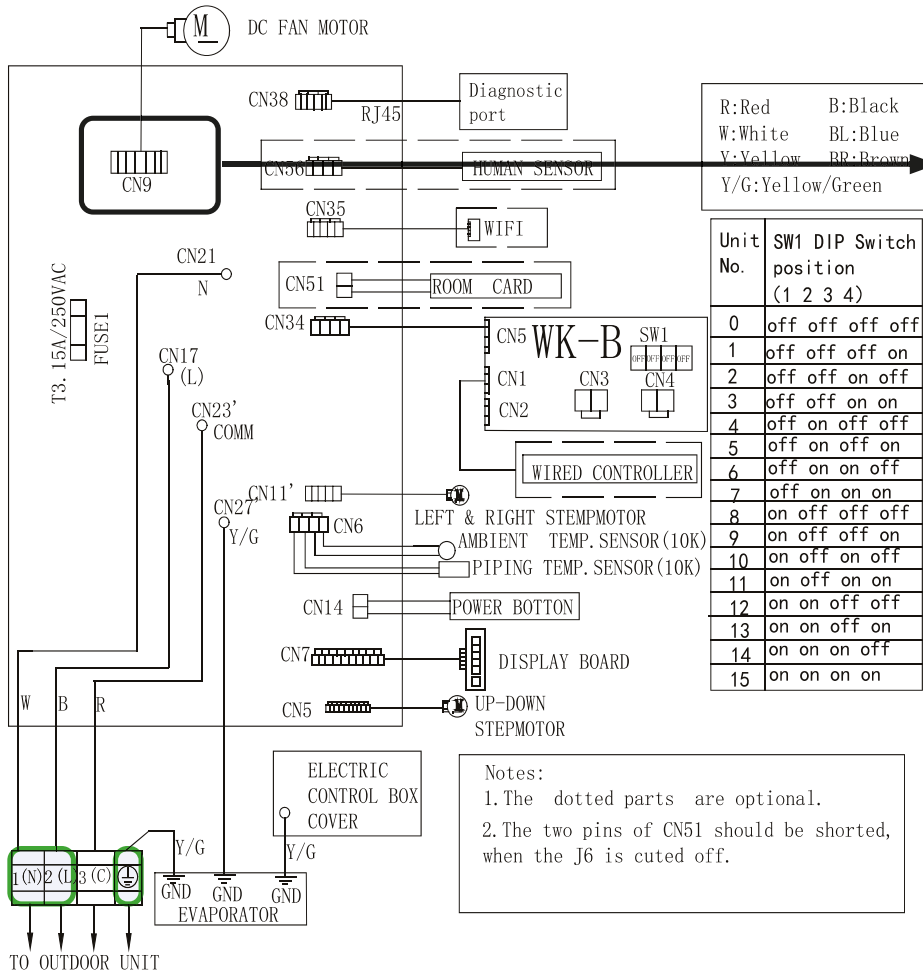

Model selection:

09K	model-23	code - BM1	- 1 off	2 off	
12K	model-26	code - BM1	- 1 off	2 on	
18K	model-33	code - BM1	- 1 on	2 off	

Notes: Before replacing the board, it is necessary to ensure that the machine is matched with the board code

Troubleshooting

Checking System Components

NOTE: Component resistance readings shown in this section are for reference only. Actual resistance values may differ based on model being tested.

Component readings shown below are based on the models of 1U*EH2VHD outdoor unit.

Checking Outdoor Unit Components

Testing of the following components requires the use of needle probes. Avoid testing the connector end of the plug, as damage to the internal sections of the plug can occur.

Checking the Outdoor Unit Sensors

NOTE: Use respective temperature / sensor chart for sensor type being tested.

- Compressor discharge sensor
- Suction sensor
- Defrost temperature sensor
- Ambient sensor

Step 1

Disconnect the sensor plug from the control board for this test. Failure to do so may provide inaccurate readings.

Step 2

Using k-type temperature probe, determine the temperature of the sensor being tested.

Step 3

Using an ohmmeter, check the resistance value of the sensor.

Step 4

Referring to the temperature / resistance table for the sensor being checked, verify the resistance value corresponds to the temperature checked in Step 2.

Replace the sensor if the reading is open, shorted, or outside the specifications of the temperature / resistance table.

Step 5

Re-seat the plug on the connector at the conclusion of the test.

Checking the Reversing Valve Coil

Step 1

Disconnect the reversing valve plug from the PCB for this test. Failure to do so may provide inaccurate readings.

Step 2

Using an ohmmeter, check the resistance value of the coil.

The resistance value of the coil should be 1.2 kilo ohms to 1.8 kilo ohms. Replace the valve coil if the reading is significantly different, or if the coil shows open or shorted.

Step 3

Re-seat the plug on the connector at the conclusion of the test.

Checking the DC Fan Motor

Step 1

Using needle probes, check the DCV at the back of the fan plug on the PCB. The values are:

Red to black: +310 VDC

White to black: +15 VDC

Yellow to black: 1-4 VDC when running; 0 VDC when there is no call for heating or cooling

Blue to black: pulsing 0-8 VDC when running; 14 VDC when there is no call for heating or cooling

Checking the EEV Coil

Step 1

Disconnect the EEV coil from the PCB for this test. Failure to do so may provide inaccurate readings.

Step 2

The resistance values of plus pin combinations are 46 Ohm.

Step 3

Re-seat the plug on the connector at the conclusion of the test.

Checking the Compressor Windings

Step 1

Disconnect wiring from terminals U, V and W of the IPM.

Step 1

Using an Ohmmeter, check the resistance value of the compressor windings. Measure between wires U and V, U and W, and V, and W.

The resistance value of the windings should be balanced (equal). If the resistance values are not equal, verify the wiring and connections to the compressor as well as the compressor itself. Repair or replace as needed.

Troubleshooting

Step 3

Reconnect the wiring to the IPM at the conclusion of the test.

NOTE: Resistance readings shown in this section are for reference only

Model	Winding resistance
09K	1.98Ω
12K	1.21Ω
18K	0.88Ω

Checking the Base Pan Heater

The resistance across the heater should be 100 to 500 ohms. Replace it if the value is significantly different, or if the heater reads open or shorted.

Checking Indoor Unit Components

Testing of the following components requires the use of an ohmmeter and k-type temperature probe.

NOTE: When using the test probes, probe the back or side contacts of the plug to obtain the reading. Do not try to probe the connector end of the plug, as this may damage the contacts.

Checking the Indoor Unit Sensors

NOTE: Use respective temperature / sensor chart for sensor type being tested.

Coil sensor

Ambient sensor

Step 1

Disconnect the sensor from the PCB for this test. Failure to do so may provide inaccurate readings.

Step 2

Determine the temperature of the sensor being tested.

Step 3

Check the resistance value of the sensor.

Step 4

Referring to the temperature / resistance table for the sensor being checked, verify the resistance value corresponds to the temperature checked in step 2.

Replace the sensor if the reading is open, shorted, or outside the specifications of the temperature / resistance table.

Step 5

Re-seat the plug on the PCB at the conclusion of the test.

Checking the Up/Down Stepper Motor

Step 1

Disconnect the Up/Down Stepper Motor plug PCB for the test. Failure to do so may provide inaccurate readings.

Step 2

Refer to the chart shown below for plug pin combinations and resistance values.

	Red	Orange	Yellow	Pink	Blue
Red		296.5 Ohm	295.5 Ohm	296.3 Ohm	296.1 Ohm
Orange			594.5 Ohm	595.5 Ohm	594.5 Ohm
Yellow				594.3 Ohm	594.5 Ohm
Pink					594.3 Ohm
Blue					

Step 3

Re-seat the plug on the connector at the conclusion of the test.

Checking the Left/Right Stepper Motor

Step 1

Disconnect the Motor plug from the PCB for this test. Failure to do so may provide inaccurate readings.

Troubleshooting

Step 2

Refer to the chart shown below for plug pin combinations and resistance values.

	Red	Orange	Yellow	Pink	Blue
Red		296.5Ohm	295.5 Ohm	296.3 Ohm	296.1 Ohm
Orange			594.5 Ohm	595.5 Ohm	594.5 Ohm
Yellow				594.3 Ohm	594.5 Ohm
Pink					594.3 Ohm
Blue					

Step 3

Re-seat the plug on the PCB at the conclusion of the test.

Table of Contents

Outdoor Board Diagram	105
Indoor Board Diagram	106
Room and Pipe Sensor Tables	107
Ambient, Defrost, and Pipe Sensor Tables.....	110
Discharge Sensor Tables	113

09K

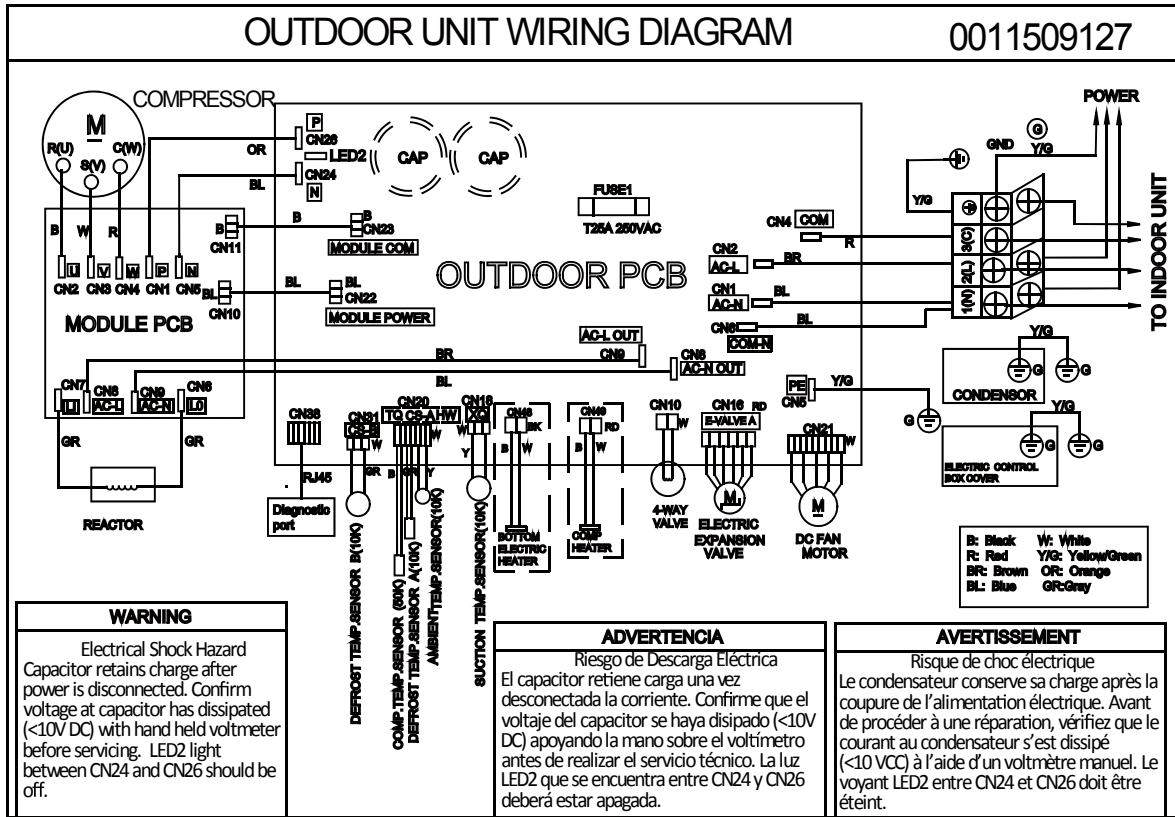

12K-18K

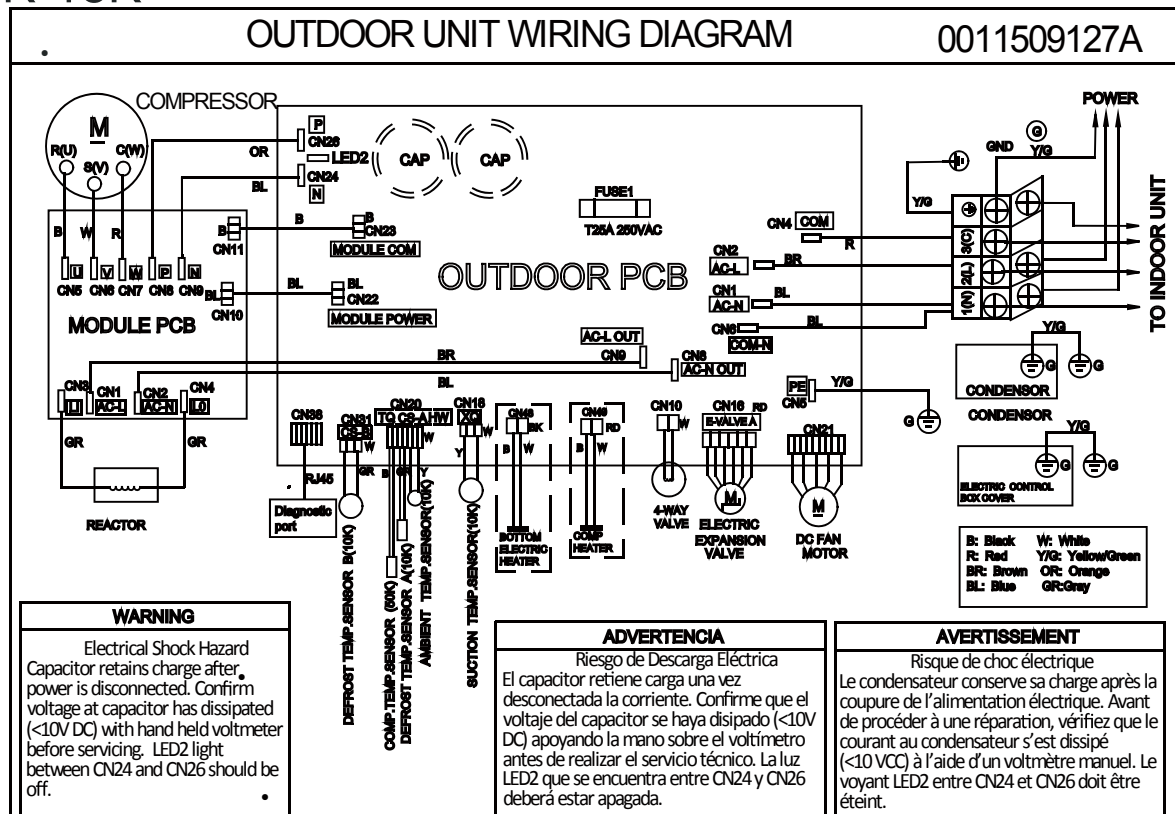

INDOOR UNIT DIAGRAM

0011509128

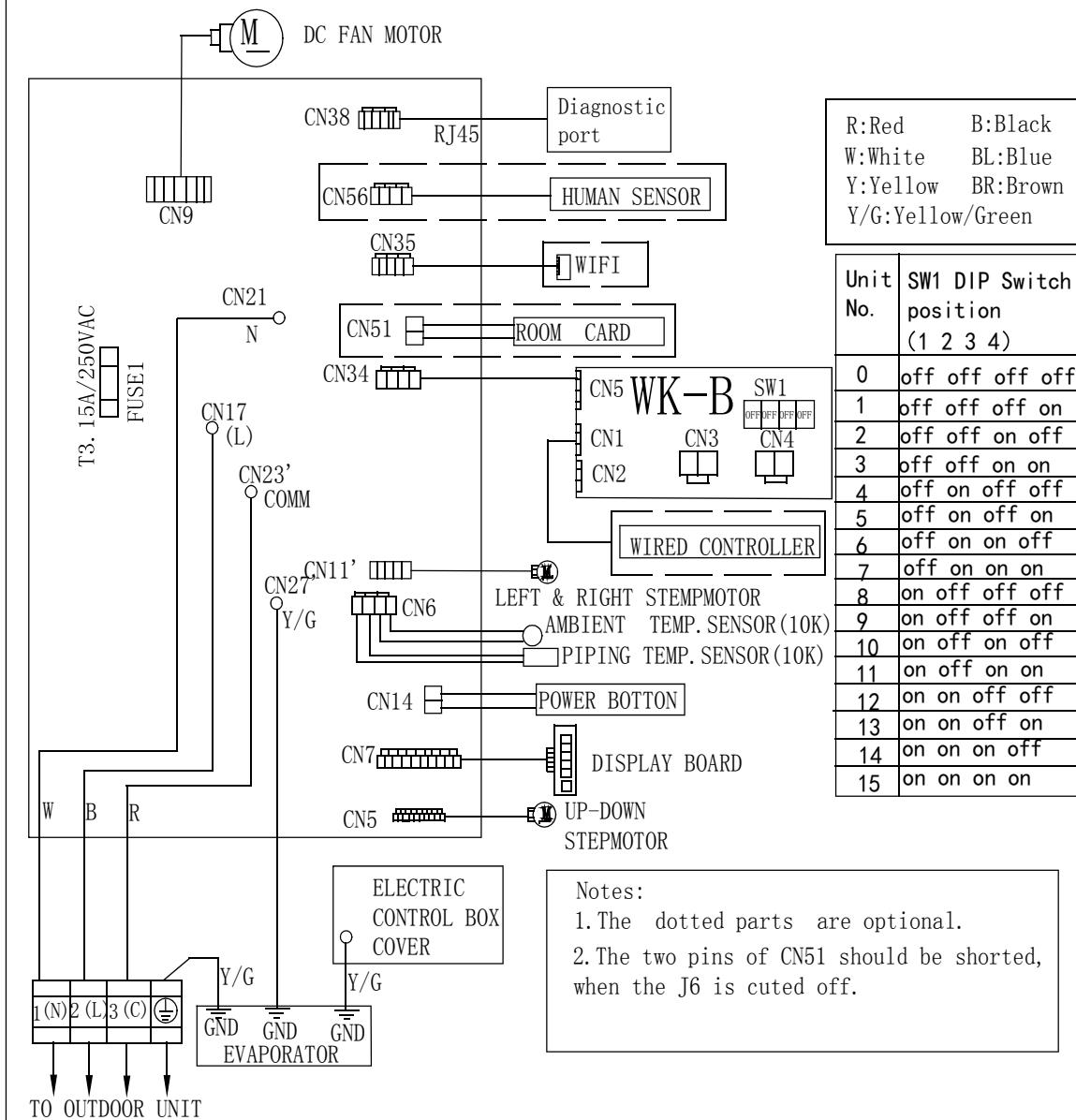

Notes:
 1. The dotted parts are optional.
 2. The two pins of CN51 should be shorted, when the J6 is cuted off.

Model selection:		Notes: Before replacing the board, it is necessary to ensure that the machine is matched with the board code	
09K	model-23 code - BM1 - 1 off 2 off		
12K	model-26 code - BM1 - 1 off 2 on		
18K	model-33 code - BM1 - 1 on 2 off		

Room and Coil Sensor Tables

R77° = 10KΩ±3%

B77°/122° = 3700K±3%

Temp.°F	Temp. °C	Max.(KΩ)	Normal(KΩ)	Min.(KΩ)	Tolerance (°C)	
-22	-30	165.217	147.9497	132.3678	-1.94	1.75
-20.2	-29	155.5754	139.56	125.0806	-1.93	1.74
-18.4	-28	146.5609	131.7022	118.2434	-1.91	1.73
-16.6	-27	138.1285	124.3392	111.8256	-1.89	1.71
-14.8	-26	130.2371	117.4366	105.7989	-1.87	1.7
-13	-25	122.8484	110.9627	100.1367	-1.85	1.69
-11.2	-24	115.9272	104.8882	94.8149	-1.83	1.67
-9.4	-23	109.441	99.1858	89.8106	-1.81	1.66
-7.6	-22	103.3598	93.8305	85.1031	-1.8	1.64
-5.8	-21	97.6556	88.7989	80.6728	-1.78	1.63
-4	-20	92.3028	84.0695	76.5017	-1.76	1.62
-2.2	-19	87.2775	79.6222	72.5729	-1.74	1.6
-0.4	-18	82.5577	75.4384	68.871	-1.72	1.59
1.4	-17	78.123	71.501	65.3815	-1.7	1.57
3.2	-16	73.9543	67.7939	62.0907	-1.68	1.55
5	-15	70.0342	64.3023	58.9863	-1.66	1.54
6.8	-14	66.3463	61.0123	56.0565	-1.64	1.52
8.6	-13	62.8755	57.911	53.2905	-1.62	1.51
10.4	-12	59.6076	54.9866	50.6781	-1.6	1.49
12.2	-11	56.5296	52.2278	48.2099	-1.58	1.47
14	-10	53.6294	49.6244	45.8771	-1.56	1.46
15.8	-9	50.8956	47.1666	43.6714	-1.54	1.44
17.6	-8	48.3178	44.8454	41.5851	-1.51	1.42
19.4	-7	45.886	42.6525	39.6112	-1.49	1.4
21.2	-6	43.5912	40.58	37.7429	-1.47	1.39
23	-5	41.4249	38.6207	35.9739	-1.45	1.37
24.8	-4	39.3792	36.7676	34.2983	-1.43	1.35
26.6	-3	37.4465	35.0144	32.7108	-1.41	1.33
28.4	-2	35.6202	33.3552	31.2062	-1.38	1.31
30.2	-1	33.8936	31.7844	29.7796	-1.36	1.29
32	0	32.2608	30.2968	28.4267	-1.34	1.28
33.8	1	30.7162	28.8875	27.1431	-1.32	1.26
35.6	2	29.2545	27.5519	25.925	-1.29	1.24
37.4	3	27.8708	26.2858	24.7686	-1.27	1.22
39.2	4	26.5605	25.0851	23.6704	-1.25	1.2
41	5	25.3193	23.9462	22.6273	-1.23	1.18
42.8	6	24.1432	22.8656	21.6361	-1.2	1.16
44.6	7	23.0284	21.8398	20.6939	-1.18	1.14
46.4	8	21.9714	20.8659	19.7982	-1.15	1.12
48.2	9	20.9688	19.9409	18.9463	-1.13	1.09
50	10	20.0176	19.0621	18.1358	-1.11	1.07
51.8	11	19.1149	18.227	17.3646	-1.08	1.05
53.6	12	18.258	17.4331	16.6305	-1.06	1.03
55.4	13	17.4442	16.6782	15.9315	-1.03	1.01
57.2	14	16.6711	15.9601	15.2657	-1.01	0.99
59	15	15.9366	15.277	14.6315	-0.98	0.96
60.8	16	15.2385	14.6268	14.0271	-0.96	0.94

Room and Coil Sensor Tables

Temp.°F	Temp.°C	Max.(KΩ)	Normal(KΩ)	Min.(KΩ)	Tolerance (°C)	
62.6	17	14.5748	14.0079	13.451	-0.93	0.92
64.4	18	13.9436	13.4185	12.9017	-0.91	0.9
66.2	19	13.3431	12.8572	12.3778	-0.88	0.87
68	20	12.7718	12.3223	11.878	-0.86	0.85
69.8	21	12.228	11.8126	11.4011	-0.83	0.83
71.6	22	11.7102	11.3267	10.9459	-0.81	0.8
73.4	23	11.2172	10.8634	10.5114	-0.78	0.78
75.2	24	10.7475	10.4216	10.0964	-0.75	0.75
77	25	10.3	10	9.7	-0.75	0.75
78.8	26	9.8975	9.5974	9.298	-0.76	0.76
80.6	27	9.5129	9.2132	8.9148	-0.8	0.8
82.4	28	9.1454	8.8465	8.5496	-0.84	0.83
84.2	29	8.7942	8.4964	8.2013	-0.87	0.86
86	30	8.4583	8.1621	7.8691	-0.91	0.9
87.8	31	8.1371	7.8428	7.5522	-0.95	0.93
89.6	32	7.8299	7.5377	7.2498	-0.98	0.97
91.4	33	7.5359	7.2461	6.9611	-1.02	1
93.2	34	7.2546	6.9673	6.6854	-1.06	1.04
95	35	6.9852	6.7008	6.4222	-1.1	1.07
96.8	36	6.7273	6.4459	6.1707	-1.13	1.11
98.6	37	6.4803	6.2021	5.9304	-1.17	1.14
100.4	38	6.2437	5.9687	5.7007	-1.21	1.18
102.2	39	6.017	5.7454	5.4812	-1.25	1.22
104	40	5.7997	5.5316	5.2712	-1.29	1.25
105.8	41	5.5914	5.3269	5.0704	-1.33	1.29
107.6	42	5.3916	5.1308	4.8783	-1.37	1.33
109.4	43	5.2001	4.943	4.6944	-1.41	1.36
111.2	44	5.0163	4.763	4.5185	-1.45	1.4
113	45	4.84	4.5905	4.35	-1.49	1.44
114.8	46	4.6708	4.4252	4.1887	-1.53	1.47
116.6	47	4.5083	4.2666	4.0342	-1.57	1.51
118.4	48	4.3524	4.1145	3.8862	-1.61	1.55
120.2	49	4.2026	3.9686	3.7443	-1.65	1.59
122	50	4.0588	3.8287	3.6084	-1.7	1.62
123.8	51	3.9206	3.6943	3.478	-1.74	1.66
125.6	52	3.7878	3.5654	3.3531	-1.78	1.7
127.4	53	3.6601	3.4416	3.2332	-1.82	1.74
129.2	54	3.5374	3.3227	3.1183	-1.87	1.78
131	55	3.4195	3.2085	3.0079	-1.91	1.82
132.8	56	3.306	3.0989	2.9021	-1.95	1.85
134.6	57	3.1969	2.9935	2.8005	-2	1.89
136.4	58	3.0919	2.8922	2.7029	-2.04	1.93
138.2	59	2.9909	2.7948	2.6092	-2.08	1.97
140	60	2.8936	2.7012	2.5193	-2.13	2.01
141.8	61	2.8	2.6112	2.4328	-2.17	2.05
143.6	62	2.7099	2.5246	2.3498	-2.22	2.09
145.4	63	2.6232	2.4413	2.27	-2.26	2.13
147.2	64	2.5396	2.3611	2.1932	-2.31	2.17

Room and Coil Sensor Tables

Temp.°F	Temp.°C	Max.(KΩ)	Normal(KΩ)	Min.(KΩ)	Tolerance (°C)	
149	65	2.4591	2.284	2.1195	-2.36	2.21
150.8	66	2.3815	2.2098	2.0486	-2.4	2.25
152.6	67	2.3068	2.1383	1.9803	-2.45	2.29
154.4	68	2.2347	2.0695	1.9147	-2.49	2.34
156.2	69	2.1652	2.0032	1.8516	-2.54	2.38
158	70	2.0983	1.9393	1.7908	-2.59	2.42
159.8	71	2.0337	1.8778	1.7324	-2.63	2.46
161.6	72	1.9714	1.8186	1.6761	-2.68	2.5
163.4	73	1.9113	1.7614	1.6219	-2.73	2.54
165.2	74	1.8533	1.7064	1.5697	-2.78	2.58
167	75	1.7974	1.6533	1.5194	-2.83	2.63
168.8	76	1.7434	1.6021	1.471	-2.88	2.67
170.6	77	1.6913	1.5528	1.4243	-2.92	2.71
172.4	78	1.6409	1.5051	1.3794	-2.97	2.75
174.2	79	1.5923	1.4592	1.336	-3.02	2.8
176	80	1.5454	1.4149	1.2942	-3.07	2.84
177.8	81	1.5	1.3721	1.254	-3.12	2.88
179.6	82	1.4562	1.3308	1.2151	-3.17	2.93
181.4	83	1.4139	1.291	1.1776	-3.22	2.97
183.2	84	1.373	1.2525	1.1415	-3.27	3.01
185	85	1.3335	1.2153	1.1066	-3.32	3.06
186.8	86	1.2953	1.1794	1.073	-3.38	3.1
188.6	87	1.2583	1.1448	1.0405	-3.43	3.15
190.4	88	1.2226	1.1113	1.0092	-3.48	3.19
192.2	89	1.188	1.0789	0.9789	-3.53	3.24
194	90	1.1546	1.0476	0.9497	-3.58	3.28
195.8	91	1.1223	1.0174	0.9215	-3.64	3.33
197.6	92	1.091	0.9882	0.8942	-3.69	3.37
199.4	93	1.0607	0.9599	0.8679	-3.74	3.42
201.2	94	1.0314	0.9326	0.8424	-3.8	3.46
203	95	1.003	0.9061	0.8179	-3.85	3.51
204.8	96	0.9756	0.8806	0.7941	-3.9	3.55
206.6	97	0.949	0.8558	0.7711	-3.96	3.6
208.4	98	0.9232	0.8319	0.7489	-4.01	3.64
210.2	99	0.8983	0.8088	0.7275	-4.07	3.69
212	100	0.8741	0.7863	0.7067	-4.12	3.74
213.8	101	0.8507	0.7646	0.6867	-4.18	3.78
215.6	102	0.8281	0.7436	0.6672	-4.23	3.83
217.4	103	0.8061	0.7233	0.6484	-4.29	3.88
219.2	104	0.7848	0.7036	0.6303	-4.34	3.92
221	105	0.7641	0.6845	0.6127	-4.4	3.97
222.8	106	0.7441	0.6661	0.5957	-4.46	4.02
224.6	107	0.7247	0.6482	0.5792	-4.51	4.07
226.4	108	0.7059	0.6308	0.5632	-4.57	4.12
228.2	109	0.6877	0.614	0.5478	-4.63	4.16
230	110	0.67	0.5977	0.5328	-4.69	4.21
231.8	111	0.6528	0.582	0.5183	-4.74	4.26
233.6	112	0.6361	0.5667	0.5043	-4.8	4.31

Room and Coil Sensor Tables

Temp.°F	Temp.°C	Max.(KΩ)	Normal(KΩ)	Min.(KΩ)	Tolerance(°C)	
235.4	113	0.62	0.5518	0.4907	-4.86	4.36
237.2	114	0.6043	0.5374	0.4775	-4.92	4.41
239	115	0.5891	0.5235	0.4648	-4.98	4.45
240.8	116	0.5743	0.51	0.4524	-5.04	4.5
242.6	117	0.56	0.4968	0.4404	-5.1	4.55
244.4	118	0.546	0.4841	0.4288	-5.16	4.6
246.2	119	0.5325	0.4717	0.4175	-5.22	4.65
248	120	0.5194	0.4597	0.4066	-5.28	4.7

Ambient , Defrost and Pipe Sensor Tables

Temp.°F	Temp.°C	Max.(KΩ)	Normal(KΩ)	Min.(KΩ)	Tolerance(°C)	
-22	-30	165.2170	147.9497	132.3678	-1.94	1.75
-20	-29	155.5754	139.5600	125.0806	-1.93	1.74
-18	-28	146.5609	131.7022	118.2434	-1.91	1.73
-17	-27	138.1285	124.3392	111.8256	-1.89	1.71
-15	-26	130.2371	117.4366	105.7989	-1.87	1.70
-13	-25	122.8484	110.9627	100.1367	-1.85	1.69
-11	-24	115.9272	104.8882	94.8149	-1.83	1.67
-9	-23	109.4410	99.1858	89.8106	-1.81	1.66
-8	-22	103.3598	93.8305	85.1031	-1.80	1.64
-6	-21	97.6556	88.7989	80.6728	-1.78	1.63
-4	-20	92.3028	84.0695	76.5017	-1.76	1.62
-2	-19	87.2775	79.6222	72.5729	-1.74	1.60
0	-18	82.5577	75.4384	68.8710	-1.72	1.59
1	-17	78.1230	71.5010	65.3815	-1.70	1.57
3	-16	73.9543	67.7939	62.0907	-1.68	1.55
5	-15	70.0342	64.3023	58.9863	-1.66	1.54
7	-14	66.3463	61.0123	56.0565	-1.64	1.52
9	-13	62.8755	57.9110	53.2905	-1.62	1.51
10	-12	59.6076	54.9866	50.6781	-1.60	1.49
12	-11	56.5296	52.2278	48.2099	-1.58	1.47
14	-10	53.6294	49.6244	45.8771	-1.56	1.46
16	-9	50.8956	47.1666	43.6714	-1.54	1.44
18	-8	48.3178	44.8454	41.5851	-1.51	1.42
19	-7	45.8860	42.6525	39.6112	-1.49	1.40
21	-6	43.5912	40.5800	37.7429	-1.47	1.39
23	-5	41.4249	38.6207	35.9739	-1.45	1.37
25	-4	39.3792	36.7676	34.2983	-1.43	1.35
27	-3	37.4465	35.0144	32.7108	-1.41	1.33
28	-2	35.6202	33.3552	31.2062	-1.38	1.31
30	-1	33.8936	31.7844	29.7796	-1.36	1.29
32	0	32.2608	30.2968	28.4267	-1.34	1.28
34	1	30.7162	28.8875	27.1431	-1.32	1.26
36	2	29.2545	27.5519	25.9250	-1.29	1.24
37	3	27.8708	26.2858	24.7686	-1.27	1.22
39	4	26.5605	25.0851	23.6704	-1.25	1.20
41	5	25.3193	23.9462	22.6273	-1.23	1.18
43	6	24.1432	22.8656	21.6361	-1.20	1.16

Ambient , Defrost and Pipe Sensor Tables

Temp.°F	Temp.°C	Max.(KΩ)	Normal(KΩ)	Min.(KΩ)	Tolerance (°C)	
45	7	23.0284	21.8398	20.6939	-1.18	1.14
46	8	21.9714	20.8659	19.7982	-1.15	1.12
48	9	20.9688	19.9409	18.9463	-1.13	1.09
50	10	20.0176	19.0621	18.1358	-1.11	1.07
52	11	19.1149	18.2270	17.3646	-1.08	1.05
54	12	18.2580	17.4331	16.6305	-1.06	1.03
55	13	17.4442	16.6782	15.9315	-1.03	1.01
57	14	16.6711	15.9601	15.2657	-1.01	0.99
59	15	15.9366	15.2770	14.6315	-0.98	0.96
61	16	15.2385	14.6268	14.0271	-0.96	0.94
63	17	14.5748	14.0079	13.4510	-0.93	0.92
64	18	13.9436	13.4185	12.9017	-0.91	0.90
66	19	13.3431	12.8572	12.3778	-0.88	0.87
68	20	12.7718	12.3223	11.8780	-0.86	0.85
70	21	12.2280	11.8126	11.4011	-0.83	0.83
72	22	11.7102	11.3267	10.9459	-0.81	0.80
73	23	11.2172	10.8634	10.5114	-0.78	0.78
75	24	10.7475	10.4216	10.0964	-0.75	0.75
77	25	10.3000	10.0000	9.7000	-0.75	0.75
79	26	9.8975	9.5974	9.2980	-0.76	0.76
81	27	9.5129	9.2132	8.9148	-0.80	0.80
82	28	9.1454	8.8465	8.5496	-0.84	0.83
84	29	8.7942	8.4964	8.2013	-0.87	0.86
86	30	8.4583	8.1621	7.8691	-0.91	0.90
88	31	8.1371	7.8428	7.5522	-0.95	0.93
90	32	7.8299	7.5377	7.2498	-0.98	0.97
91	33	7.5359	7.2461	6.9611	-1.02	1.00
93	34	7.2546	6.9673	6.6854	-1.06	1.04
95	35	6.9852	6.7008	6.4222	-1.10	1.07
97	36	6.7273	6.4459	6.1707	-1.13	1.11
99	37	6.4803	6.2021	5.9304	-1.17	1.14
100	38	6.2437	5.9687	5.7007	-1.21	1.18
102	39	6.0170	5.7454	5.4812	-1.25	1.22
104	40	5.7997	5.5316	5.2712	-1.29	1.25
106	41	5.5914	5.3269	5.0704	-1.33	1.29
108	42	5.3916	5.1308	4.8783	-1.37	1.33
109	43	5.2001	4.9430	4.6944	-1.41	1.36
111	44	5.0163	4.7630	4.5185	-1.45	1.40
113	45	4.8400	4.5905	4.3500	-1.49	1.44
115	46	4.6708	4.4252	4.1887	-1.53	1.47
117	47	4.5083	4.2666	4.0342	-1.57	1.51
118	48	4.3524	4.1145	3.8862	-1.61	1.55
120	49	4.2026	3.9686	3.7443	-1.65	1.59
122	50	4.0588	3.8287	3.6084	-1.70	1.62
124	51	3.9206	3.6943	3.4780	-1.74	1.66
126	52	3.7878	3.5654	3.3531	-1.78	1.70
127	53	3.6601	3.4416	3.2332	-1.82	1.74
129	54	3.5374	3.3227	3.1183	-1.87	1.78

Ambient , Defrost and Pipe Sensor Tables

Temp. °F	Temp. °C	Max.(KΩ)	Normal(KΩ)	Min.(KΩ)	Tolerance(°C)	
131	55	3.4195	3.2085	3.0079	-1.91	1.82
133	56	3.3060	3.0989	2.9021	-1.95	1.85
135	57	3.1969	2.9935	2.8005	-2.00	1.89
136	58	3.0919	2.8922	2.7029	-2.04	1.93
138	59	2.9909	2.7948	2.6092	-2.08	1.97
140	60	2.8936	2.7012	2.5193	-2.13	2.01
142	61	2.8000	2.6112	2.4328	-2.17	2.05
144	62	2.7099	2.5246	2.3498	-2.22	2.09
145	63	2.6232	2.4413	2.2700	-2.26	2.13
147	64	2.5396	2.3611	2.1932	-2.31	2.17
149	65	2.4591	2.2840	2.1195	-2.36	2.21
151	66	2.3815	2.2098	2.0486	-2.40	2.25
153	67	2.3068	2.1383	1.9803	-2.45	2.29
154	68	2.2347	2.0695	1.9147	-2.49	2.34
156	69	2.1652	2.0032	1.8516	-2.54	2.38
158	70	2.0983	1.9393	1.7908	-2.59	2.42
160	71	2.0337	1.8778	1.7324	-2.63	2.46
162	72	1.9714	1.8186	1.6761	-2.68	2.50
163	73	1.9113	1.7614	1.6219	-2.73	2.54
165	74	1.8533	1.7064	1.5697	-2.78	2.58
167	75	1.7974	1.6533	1.5194	-2.83	2.63
169	76	1.7434	1.6021	1.4710	-2.88	2.67
171	77	1.6913	1.5528	1.4243	-2.92	2.71
172	78	1.6409	1.5051	1.3794	-2.97	2.75
174	79	1.5923	1.4592	1.3360	-3.02	2.80
176	80	1.5454	1.4149	1.2942	-3.07	2.84
178	81	1.5000	1.3721	1.2540	-3.12	2.88
180	82	1.4562	1.3308	1.2151	-3.17	2.93
181	83	1.4139	1.2910	1.1776	-3.22	2.97
183	84	1.3730	1.2525	1.1415	-3.27	3.01
185	85	1.3335	1.2153	1.1066	-3.32	3.06
187	86	1.2953	1.1794	1.0730	-3.38	3.10
189	87	1.2583	1.1448	1.0405	-3.43	3.15
190	88	1.2226	1.1113	1.0092	-3.48	3.19
192	89	1.1880	1.0789	0.9789	-3.53	3.24
194	90	1.1546	1.0476	0.9497	-3.58	3.28
196	91	1.1223	1.0174	0.9215	-3.64	3.33
198	92	1.0910	0.9882	0.8942	-3.69	3.37
199	93	1.0607	0.9599	0.8679	-3.74	3.42
201	94	1.0314	0.9326	0.8424	-3.80	3.46
203	95	1.0030	0.9061	0.8179	-3.85	3.51
205	96	0.9756	0.8806	0.7941	-3.90	3.55
207	97	0.9490	0.8558	0.7711	-3.96	3.60
208	98	0.9232	0.8319	0.7489	-4.01	3.64
210	99	0.8983	0.8088	0.7275	-4.07	3.69
212	100	0.8741	0.7863	0.7067	-4.12	3.74
214	101	0.8507	0.7646	0.6867	-4.18	3.78
216	102	0.8281	0.7436	0.6672	-4.23	3.83

Ambient , Defrost and Pipe Sensor Tables

Temp. °F	Temp. °C	Max.(KΩ)	Normal(KΩ)	Min.(KΩ)	Tolerance(°C)	
217	103	0.8061	0.7233	0.6484	-4.29	3.88
219	104	0.7848	0.7036	0.6303	-4.34	3.92
221	105	0.7641	0.6845	0.6127	-4.40	3.97
223	106	0.7441	0.6661	0.5957	-4.46	4.02
225	107	0.7247	0.6482	0.5792	-4.51	4.07
226	108	0.7059	0.6308	0.5632	-4.57	4.12
228	109	0.6877	0.6140	0.5478	-4.63	4.16
230	110	0.6700	0.5977	0.5328	-4.69	4.21
232	111	0.6528	0.5820	0.5183	-4.74	4.26
234	112	0.6361	0.5667	0.5043	-4.80	4.31
235	113	0.6200	0.5518	0.4907	-4.86	4.36
237	114	0.6043	0.5374	0.4775	-4.92	4.41
239	115	0.5891	0.5235	0.4648	-4.98	4.45
241	116	0.5743	0.5100	0.4524	-5.04	4.50
243	117	0.5600	0.4968	0.4404	-5.10	4.55
244	118	0.5460	0.4841	0.4288	-5.16	4.60
246	119	0.5325	0.4717	0.4175	-5.22	4.65
248	120	0.5194	0.4597	0.4066	-5.28	4.70

Discharge Sensor Tables

R176° = 50KΩ±3%

B77°/176° = 4450K±3%

Temp.(°F)	Temp.(°C)	Max.(KΩ)	Normal(KΩ)	Min.(KΩ)	Tolerance	
-22	-30	14646.0505	12061.7438	9924.4999	-2.96	2.45
-20.2	-29	13654.1707	11267.873	9290.2526	-2.95	2.44
-18.4	-28	12735.8378	10531.3695	8700.6388	-2.93	2.44
-16.6	-27	11885.1336	9847.724	8152.2338	-2.92	2.43
-14.8	-26	11096.6531	9212.8101	7641.8972	-2.91	2.42
-13	-25	10365.4565	8622.8491	7166.7474	-2.9	2.42
-11.2	-24	9687.027	8074.3787	6724.1389	-2.88	2.41
-9.4	-23	9057.2314	7564.2244	6311.6413	-2.87	2.41
-7.6	-22	8472.2852	7089.4741	5927.0206	-2.86	2.4
-5.8	-21	7928.7217	6647.4547	5568.2222	-2.84	2.39
-4	-20	7423.3626	6235.7109	5233.3554	-2.83	2.39
-2.2	-19	6953.293	5851.9864	4920.6791	-2.82	2.38
-0.4	-18	6515.8375	5494.2064	4628.5894	-2.8	2.37
1.4	-17	6108.5393	5160.4621	4355.6078	-2.79	2.37
3.2	-16	5729.1413	4848.9963	4100.3708	-2.77	2.36
5	-15	5375.5683	4558.1906	3861.6201	-2.76	2.35
6.8	-14	5045.9114	4286.5535	3638.1938	-2.75	2.34
8.6	-13	4738.4141	4032.7098	3429.0191	-2.73	2.34
10.4	-12	4451.4586	3795.391	3233.1039	-2.72	2.33
12.2	-11	4183.5548	3573.426	3049.5312	-2.7	2.32
14	-10	3933.3289	3365.7336	2877.4527	-2.69	2.31
15.8	-9	3699.5139	3171.3148	2716.0828	-2.67	2.3
17.6	-8	3480.9407	2989.246	2564.6945	-2.66	2.29
19.4	-7	3276.5302	2818.6731	2422.6139	-2.64	2.28
21.2	-6	3085.2854	2658.8058	2289.2164	-2.63	2.28
23	-5	2906.2851	2508.9126	2163.923	-2.61	2.27

Discharge Sensor Tables

Temp.(°F)	Temp.(°C)	Max.(KΩ)	Normal(KΩ)	Min.(KΩ)	Tolerance	
24.8	-4	2738.6777	2368.3158	2046.1961	-2.6	2.26
26.6	-3	2581.6752	2236.3876	1935.5371	-2.58	2.25
28.4	-2	2434.5487	2112.5459	1831.4826	-2.56	2.24
30.2	-1	2296.623	1996.2509	1733.6024	-2.55	2.23
32	0	2167.273	1887.0018	1641.4966	-2.53	2.22
33.8	1	2045.9191	1784.3336	1554.7931	-2.52	2.21
35.6	2	1932.0242	1687.8144	1473.146	-2.5	2.2
37.4	3	1825.0899	1597.0431	1396.2333	-2.48	2.19
39.2	4	1724.654	1511.6468	1323.7551	-2.47	2.17
41	5	1630.287	1431.2787	1255.4324	-2.45	2.16
42.8	6	1541.5904	1355.6163	1191.0048	-2.43	2.15
44.6	7	1458.1938	1284.3593	1130.2298	-2.41	2.14
46.4	8	1379.7528	1217.2282	1072.8813	-2.4	2.13
48.2	9	1305.9472	1153.9626	1018.7481	-2.38	2.12
50	10	1236.4792	1094.32	967.6334	-2.36	2.11
51.8	11	1171.0715	1038.0743	919.3533	-2.35	2.09
53.6	12	1109.4661	985.0146	873.7359	-2.33	2.08
55.4	13	1051.4226	934.944	830.621	-2.31	2.07
57.2	14	996.7169	887.6792	789.8583	-2.29	2.06
59	15	945.1404	843.0486	751.3077	-2.27	2.04
60.8	16	896.4981	800.8922	714.838	-2.26	2.03
62.6	17	850.6086	761.0603	680.3265	-2.24	2.02
64.4	18	807.3024	723.4134	647.658	-2.22	2
66.2	19	766.4212	687.8205	616.7252	-2.2	1.99
68	20	727.8172	654.1596	587.4271	-2.18	1.98
69.8	21	691.3524	622.3161	559.6694	-2.16	1.96
71.6	22	656.8979	592.1831	533.3634	-2.14	1.95
73.4	23	624.3328	563.6604	508.4261	-2.12	1.93
75.2	24	593.5446	536.654	484.7796	-2.1	1.92
77	25	564.4275	511.076	462.351	-2.09	1.9
78.8	26	536.9865	486.9352	441.1516	-2.07	1.89
80.6	27	511.0105	464.05	421.0258	-2.05	1.87
82.4	28	486.4151	442.3499	401.9146	-2.03	1.86
84.2	29	463.1208	421.7683	383.7626	-2.01	1.84
86	30	441.0535	402.243	366.5175	-1.99	1.83
87.8	31	420.1431	383.7151	350.1301	-1.97	1.81
89.6	32	400.3242	366.1295	334.5542	-1.95	1.8
91.4	33	381.535	349.4341	319.746	-1.93	1.78
93.2	34	363.7176	333.5801	305.6645	-1.9	1.76
95	35	346.8176	318.5216	292.2709	-1.88	1.75
96.8	36	330.7839	304.2151	279.5286	-1.86	1.73
98.6	37	315.5682	290.6199	267.4031	-1.84	1.71
100.4	38	301.1254	277.6976	255.862	-1.82	1.7
102.2	39	287.4128	265.4119	244.8745	-1.8	1.68
104	40	274.3905	253.7288	234.4118	-1.78	1.66
105.8	41	262.0206	242.6161	224.4465	-1.76	1.64
107.6	42	250.2676	232.0436	214.9529	-1.74	1.63
109.4	43	239.0983	221.9825	205.9065	-1.71	1.61
111.2	44	228.4809	212.406	197.2844	-1.69	1.59

Discharge Sensor Tables

Temp.(°F)	Temp.(°C)	Max.(KΩ)	Normal(KΩ)	Min.(KΩ)	Tolerance	
113	45	218.386	203.2887	189.0648	-1.67	1.57
114.8	46	208.7855	194.6066	181.2273	-1.65	1.55
116.6	47	199.6531	186.3369	173.7524	-1.63	1.54
118.4	48	190.9639	178.4584	166.6217	-1.6	1.52
120.2	49	182.6945	170.9508	159.8181	-1.58	1.5
122	50	174.8228	163.7951	153.3249	-1.56	1.48
123.8	51	167.328	156.9733	147.1268	-1.53	1.46
125.6	52	160.1904	150.4683	141.209	-1.51	1.44
127.4	53	153.3914	144.2641	135.5577	-1.49	1.42
129.2	54	146.9136	138.3454	130.1598	-1.47	1.4
131	55	140.7403	132.698	125.0027	-1.44	1.38
132.8	56	134.8559	127.3081	120.0746	-1.42	1.36
134.6	57	129.2457	122.163	115.3645	-1.4	1.34
136.4	58	123.8956	117.2504	110.8618	-1.37	1.32
138.2	59	118.7926	112.5589	106.5564	-1.35	1.3
140	60	113.9241	108.0776	102.4388	-1.32	1.28
141.8	61	109.2784	103.7961	98.5	-1.3	1.26
143.6	62	104.8443	99.7046	94.7315	-1.28	1.23
145.4	63	100.6112	95.7939	91.1253	-1.25	1.21
147.2	64	96.5692	92.0553	87.6735	-1.23	1.19
149	65	92.7088	88.4805	84.369	-1.2	1.17
150.8	66	89.0211	85.0614	81.2048	-1.18	1.15
152.6	67	85.4976	81.7908	78.1744	-1.15	1.12
154.4	68	82.1303	78.6615	75.2715	-1.13	1.1
156.2	69	78.9116	75.6668	72.4902	-1.1	1.08
158	70	75.8343	72.8004	69.8249	-1.08	1.06
159.8	71	72.8916	70.0561	67.2703	-1.05	1.03
161.6	72	70.077	67.4283	64.8213	-1.03	1.01
163.4	73	67.3844	64.9115	62.4731	-1	0.99
165.2	74	64.808	62.5006	60.2211	-0.98	0.96
167	75	62.3423	60.1906	58.0609	-0.95	0.94
168.8	76	59.9821	57.977	55.9885	-0.92	0.92
170.6	77	57.7223	55.8552	53.9998	-0.9	0.89
172.4	78	55.5583	53.821	52.0912	-0.87	0.87
174.2	79	53.4856	51.8706	50.2591	-0.85	0.84
176	80	51.5	50	48.5	-0.85	0.84
177.8	81	49.7063	48.2057	46.7083	-0.85	0.85
179.6	82	47.9835	46.4842	44.9911	-0.89	0.89
181.4	83	46.3286	44.8323	43.3452	-0.93	0.92
183.2	84	44.7385	43.2468	41.7672	-0.96	0.95
185	85	43.2105	41.7248	40.254	-1	0.99
186.8	86	41.7386	40.2604	38.7996	-1.03	1.02
188.6	87	40.3241	38.8545	37.4048	-1.07	1.06
190.4	88	38.9643	37.5045	36.0668	-1.11	1.09
192.2	89	37.6569	36.2078	34.7831	-1.14	1.13
194	90	36.3996	34.9622	33.5513	-1.18	1.16
195.8	91	35.1903	33.7653	32.3689	-1.22	1.19
197.6	92	34.0269	32.6151	31.2338	-1.26	1.23
199.4	93	32.9075	31.5096	30.1438	-1.3	1.27

Discharge Sensor Tables

Temp.(°F)	Temp.(°C)	Max.(KΩ)	Normal(KΩ)	Min.(KΩ)	Tolerance	
201.2	94	31.8302	30.4467	29.097	-1.33	1.3
203	95	30.7933	29.4246	28.0915	-1.37	1.34
204.8	96	29.795	28.4417	27.1254	-1.41	1.37
206.6	97	28.8337	27.4961	26.197	-1.45	1.41
208.4	98	27.9078	26.5864	25.3048	-1.49	1.44
210.2	99	27.016	25.711	24.447	-1.53	1.48
212	100	26.1569	24.8685	23.6222	-1.57	1.52
213.8	101	25.329	24.0574	22.8291	-1.61	1.55
215.6	102	24.5311	23.2765	22.0662	-1.65	1.59
217.4	103	23.762	22.5245	21.3323	-1.69	1.63
219.2	104	23.0205	21.8002	20.6261	-1.73	1.66
221	105	22.3055	21.1025	19.9465	-1.77	1.7
222.8	106	21.6159	20.4303	19.2924	-1.81	1.74
224.6	107	20.9508	19.7825	18.6626	-1.85	1.77
226.4	108	20.3091	19.1582	18.0563	-1.89	1.81
228.2	109	19.6899	18.5564	17.4723	-1.93	1.85
230	110	19.0924	17.9761	16.9098	-1.98	1.89
231.8	111	18.5157	17.4166	16.368	-2.02	1.93
233.6	112	17.959	16.8769	15.8458	-2.06	1.96
235.4	113	17.4214	16.3564	15.3427	-2.1	2
237.2	114	16.9023	15.8542	14.8577	-2.15	2.04
239	115	16.401	15.3696	14.3902	-2.19	2.08
240.8	116	15.9167	14.902	13.9394	-2.23	2.12
242.6	117	15.4489	14.4506	13.5047	-2.27	2.16
244.4	118	14.9968	14.0149	13.0855	-2.32	2.19
246.2	119	14.5599	13.5942	12.6811	-2.36	2.23
248	120	14.1376	13.1879	12.2909	-2.41	2.27
249.8	121	13.7294	12.7955	11.9144	-2.45	2.31
251.6	122	13.3347	12.4165	11.551	-2.5	2.35
253.4	123	12.9531	12.0503	11.2003	-2.54	2.39
255.2	124	12.584	11.6965	10.8617	-2.58	2.43
257	125	12.227	11.3545	10.5348	-2.63	2.47
258.8	126	11.8817	11.024	10.2191	-2.68	2.51
260.6	127	11.5475	10.7046	9.9142	-2.72	2.55
262.4	128	11.2242	10.3957	9.6197	-2.77	2.59
264.2	129	10.9112	10.097	9.3352	-2.81	2.63
266	130	10.6084	9.8082	9.0602	-2.86	2.67
267.8	131	10.3151	9.5288	8.7945	-2.91	2.71
269.6	132	10.0312	9.2586	8.5378	-2.95	2.75
271.4	133	9.7563	8.9971	8.2895	-3	2.8
273.2	134	9.4901	8.7441	8.0495	-3.05	2.84
275	135	9.2322	8.4993	7.8175	-3.09	2.88
276.8	136	8.9824	8.2623	7.5931	-3.14	2.92
278.6	137	8.7404	8.0329	7.376	-3.19	2.96
280.4	138	8.5059	7.8108	7.166	-3.24	3
282.2	139	8.2787	7.5958	6.9629	-3.29	3.04
284	140	8.0584	7.3875	6.7664	-3.33	3.09

www.geappliances.com



GE APPLIANCES
a Haier company

GE Appliances, A Haier Company
Appliance Park, Louisville, KY 40225
©2021 GE Appliances, A Haier Company

Revision Date: March 2021