

FlexFit PRO



Haier

CONTENTS

Part 1 General Information	1
1. Lineup	2
2. Features	3
Part 2 Indoor Unit Technical Overview - Wall Mount	5
1. Components	5
2. Testing	13
3. Error Codes	15
Part 3 Indoor Units--4-Way Cassette Type	19
1. Features	20
2. Specifications	21
3. Dimensions	24
4. PCB Configuration	25
5. Air Velocity and Temperatures	26
6. Installation	30
Part 4 Indoor Units-Medium ESP Duct Type	36
1. Features	37
2. Specifications	38
3. Dimensions	41
4. PCB Configuration	43
5. Instalaltion	45
Part 5 Outdoor Units	51
1. Specifications	50
2. Dimensions	53
3. Piping	55
4. PCB Configuration	56
5. Installation	58
Part 6 Controls and Troubleshooting	63
1. Indoor Unit PCB	64
2. Dip Switches	65
3. Outdoor Unit PCB	68
4. Error Codes	70
5. Error Code Analysis	83
6. Functions	92
7. Controllers	104
Part 7 Appendix	
1. Sensor Characteristics	104

Part 1 General Information

Part 1 General Information1

1. Lineup.....2

2. Features3



3.Indoor Unit Technical Overview - Wall Mount 5

4.Components..... 5



5.Testing.....13

6.Error Codes.....15

1. Line up

	Model	Apperance
Outdoor unit	1U24LP2VHA 1U36LP2VHA	
	1U48LP2VHA	

		Model	Apperance
Indoor unit	High-Wall	AW24LP2VHA AW36LP2VHA	

		Model	Apperance
Indoor unit	4-Way Cassette	AL24LP2VHA AL36LP2VHA	
		AL48LP2VHA	
	Medium Esp Duct	AM24LP2VHA	
		AM36LP2VHA AM48LP2VHA	

		Model	Apperance
Panel	4-Way Cassette	PB-950KB	

2. Features

Double side 4 handles

Two handles on each side make installation a breeze.



Stylish Design

Built-in service valves mean a clean looking exterior and allow for a 4-direction line set connection.

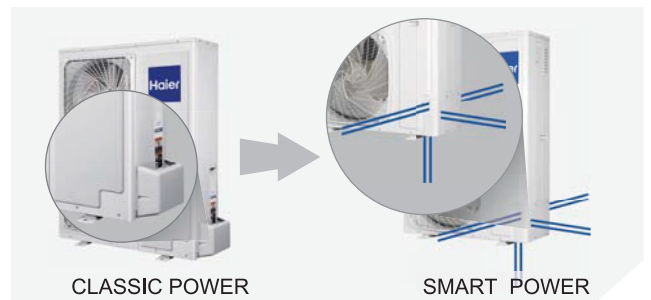

Easy Installation "888" Digital Display

Easy for technicians to check running parameters and error codes.

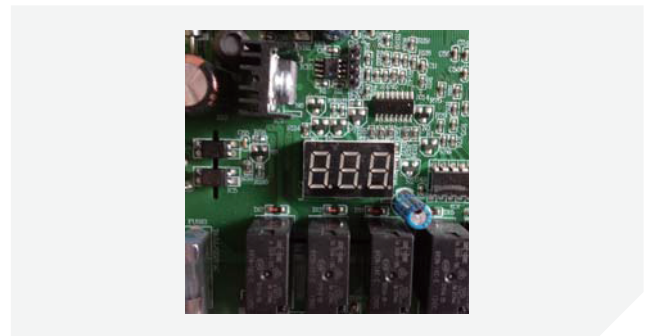

Low Sound Level Super big inlet grille

Inlet grille is 23% larger than conventional models, which means quiet operation and lower air speed.

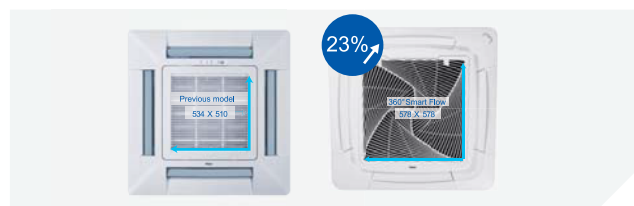

New Fan

Larger size and aerodynamic design mean low sound and less resistance.

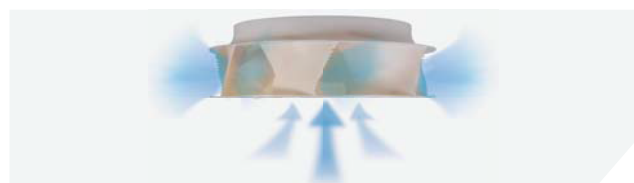

Comfort 360° air supply

360 degree air pattern eliminates dead air spots and

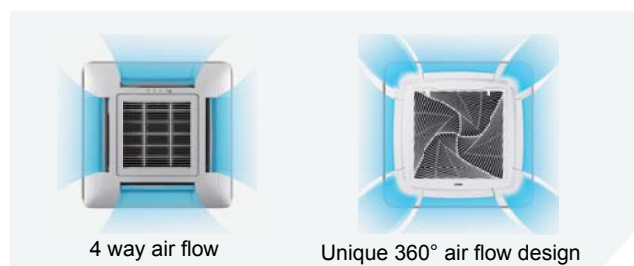

Easy Installation Convenient Grille Clip

Holds grille in place during installation to save time and effort.



Model Name and Operation Range	System Type	Wall Mount	Wall Mount
	Outdoor	1U24LP2VHA	1U36LP2VHA
	Indoor	AW24LP2VH*	AW36LP2VH*
Power Supply	Voltage, Cycle, Phase <i>V/Hz/-</i>	208-230/60/1	208-230/60/1
	Wire Size between ID and OD	14/4 AWG Stranded	14/4 AWG Stranded
	Maximum Fuse Size <i>A</i>	25	30
	Minimum Circuit Amp <i>A</i>	21	26
Cooling	Rated Capacity <i>Btu/hr</i>	24000	35000
	Capacity Range <i>Btu/hr</i>	6800-30700	8500-37500
	Rated Power Input <i>W</i>	2,182	3,500
	SEER	17.0	17.0
	EER	11.0	10.0
	Moisture Removal <i>Pt./h</i>	4.10	5.1
Heating	Rate Heating Capacity 47°F <i>Btu/hr</i>	27000	37000
	Heating Capacity Range <i>Btu/hr</i>	6800-34100	8500-41000
	Rated Power Input <i>W</i>	2700	3700
	HSPF	10.0	10.0
Outdoor Unit	Outdoor Noise Level <i>dB</i>	47	52
	Dimension: Height <i>in (mm)</i>	38 (965)	38 (965)
	Dimension: Width <i>in (mm)</i>	37 3/8(950)	37 3/8(950)
	Dimension: Depth <i>in (mm)</i>	14 5/8(370)	14 5/8(370)
	Weight (Ship/Net)- <i>lbs (kg)</i>	202.8/ 176.4 (92/80)	207.2/180.7 (94/82)
Indoor Unit	Indoor Sound Level <i>dB</i> (Turbo/High/Med/Low/Quiet)	49/47/42/36/34	50/48/44/38/36
	Airflow (Turbo/High/Med/Low/Quiet) <i>CFM</i>	710/650/560/440/410	720/660/570/450/420
	Dimension: Height <i>in (mm)</i>	13 1/4(336)	14 3/8(365)
	Dimension: Width <i>in (mm)</i>	43 7/8(1115)	51 13/16(1316)
	Dimension: Depth <i>in (mm)</i>	9 9/16(243)	10 7/8(275)
	Max. External Static Pressure <i>in.W.G(Pa)</i>	NA	NA
	Drainpipe Size O.D. <i>in</i>	NA	NA
	Internal Condensate Pump	NA	NA
	Max. Drain-Lift height <i>in(mm)</i>	NA	NA
	Grill Model	NA	NA
	Grill Dimension: H×W×D <i>in (mm)</i>	NA	NA
	Weight (Ship/Net)- <i>lbs (kg)</i>	45.4/37.5(20.6/17)	55.1/46.3(25.5/21)
Refrigerate Line	Connections	Flare	Flare
	Liquid/Suction O.D. <i>in</i>	3/8 5/8	3/8 5/8
	Factory Charge <i>Oz</i>	88.2	88.2
	Maximum Line Length <i>Ft / m</i>	165/50	165/50
	Maximum Height <i>Ft / m</i>	100/30	100/30

0010561514F

INDOOR UNIT DIAGRAM

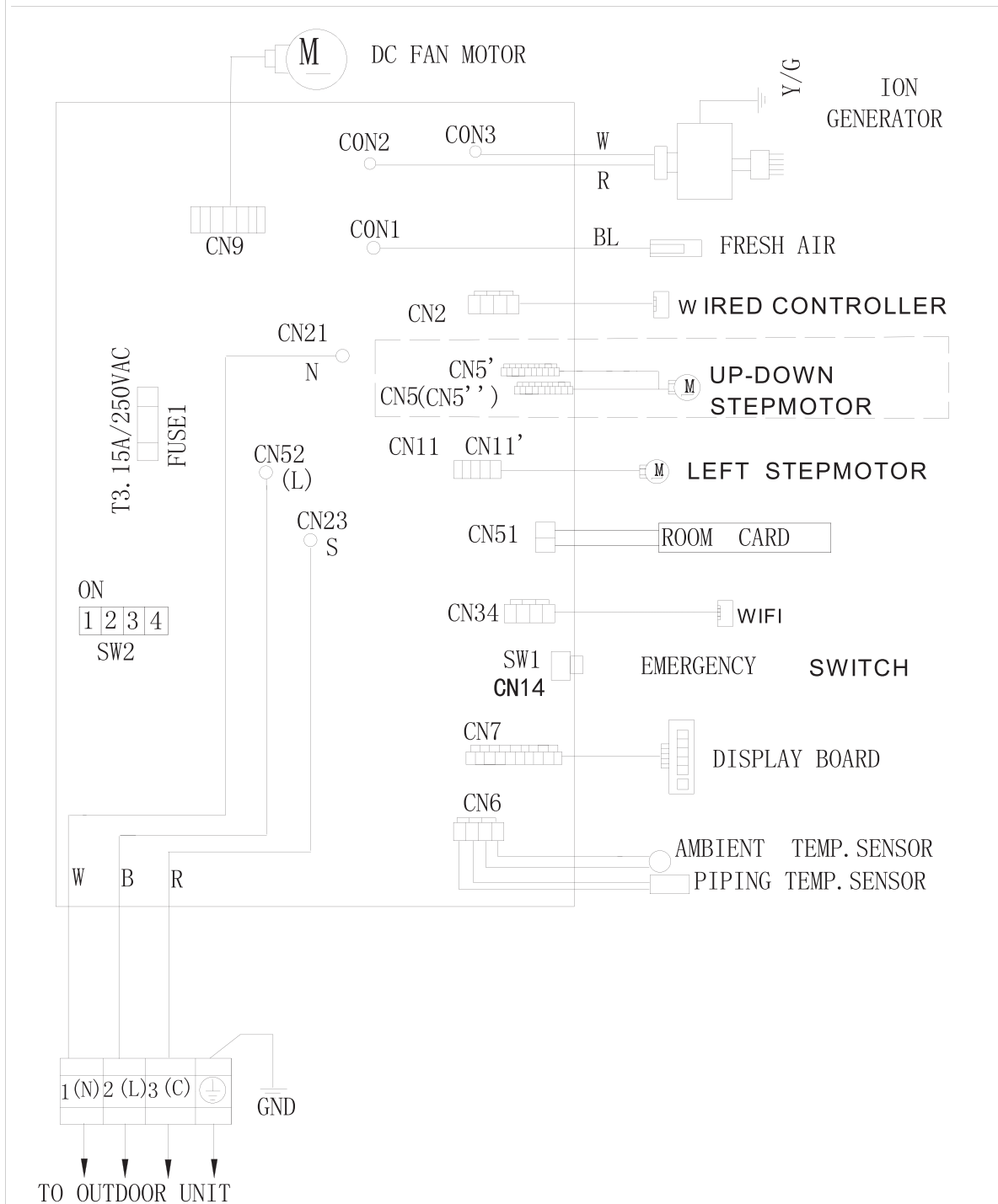

Notes:

1. The dotted parts are optional.
2. The two pins of CN51 should be shorted, when the second channel (RC) of SW2 is selected.

R:Red	B:Black
W:White	BL:Blue
Y:Yellow	BR:Brown
Y/G:Yellow/Green	

INDOOR UNIT TECHNICAL OVERVIEW

Indoor Wall Mount Unit Components

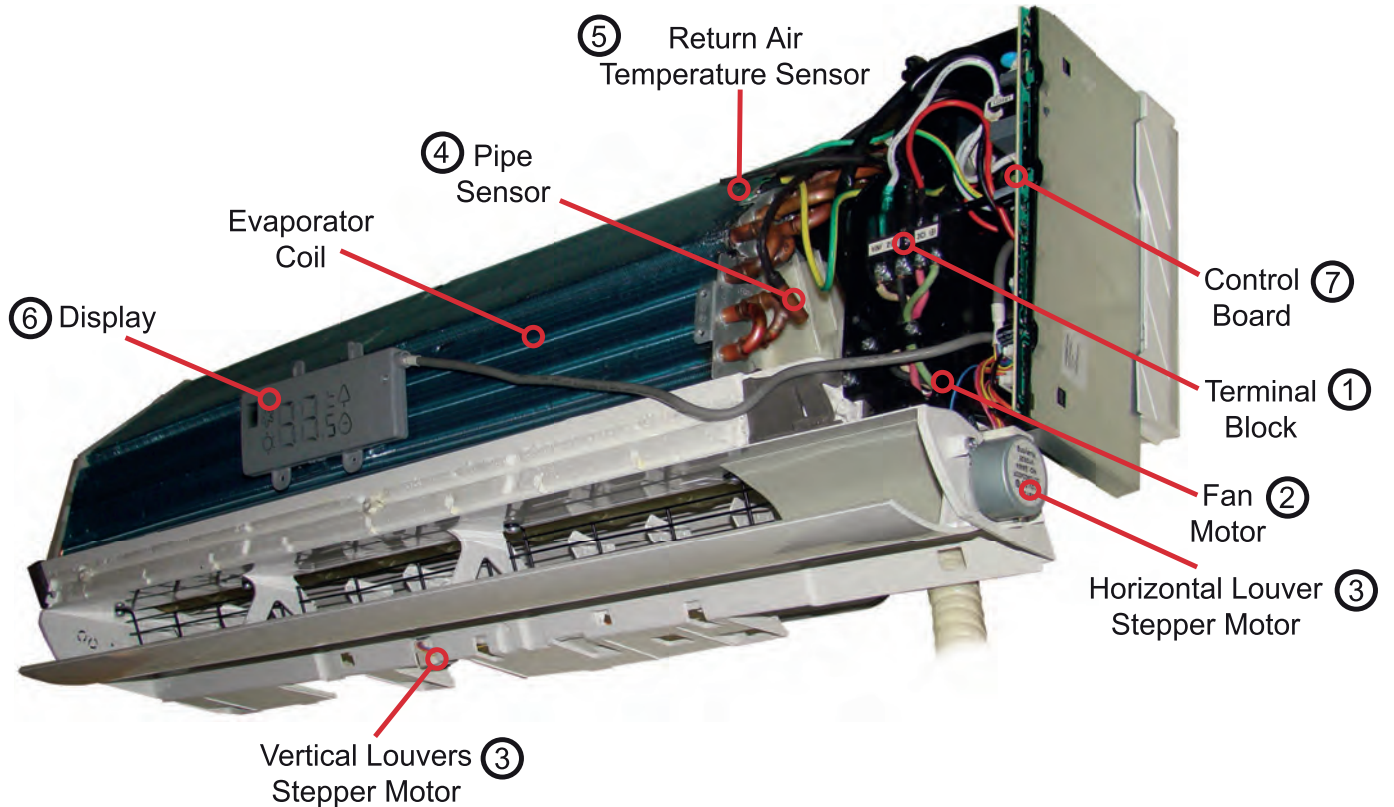

The wall mounted units act as evaporator coils during cooling mode and condenser coils during heating mode. These units have gravity condensate drain systems. If a condensate pump is needed, it must be field provided and mounted external to the indoor unit.

The wall mount unit is shipped with a wireless controller.



① Power to operate the indoor unit comes from the electrical line voltage terminal block at the outdoor unit. The wiring includes 4 wires: 1, 2, 3 and ground. Wires 1 and 3 complete the data path. These wires should always be 14 gauge AWG Stranded type wire. Splices in wires 1 or 3 may cause communication errors.

② The indoor unit features a multi-speed blower motor that will change speed to match the capacity demand from the outdoor unit. ③ Separate motors located in the indoor unit control the operation of the motorized louvers. All of the louver motors are controlled via commands received from the remote control. The blower motor is controlled by both the remote control and by commands from the outdoor unit ECU. Refer to the Remote Control Information in the Reference section for louver control/remote procedures.

Unlike typical air handlers found in the US market, these units have metering devices located in the outdoor unit. The metering devices are EEV type that are controlled by the outdoor unit ECU.

Temperature sensors located within the wall mount unit include a pipe temperature sensor and a return air temperature sensor. ④ The pipe temperature sensor is used to sense the temperature of the indoor coil in both cooling and heating modes. ⑤ The return air sensor senses the temperature of the air being drawn into the wall mounted unit from the conditioned space. The operating functions of these sensors is explained in the Temperature Sensor Function section of this manual.

⑥ The indoor unit has a display that communicates system mode, room temperature and diagnostic code information. The diagnostic code information shown on the indoor unit will NOT be the same code that is displayed on the outdoor unit. When servicing a diagnostic error, compare the indoor unit code to the outdoor unit code to make diagnostic decisions. Codes that relate to outdoor unit problems should use the outdoor unit display information as priority.

⑦ The indoor unit circuit board controls the switching functions of the indoor unit. All control decisions are made by the outdoor unit ECU. The indoor board has some limited diagnostic capability which will be covered in this manual.

The Indoor Unit Circuit Board communicates with the outdoor unit ECU via a connection at Terminal Block screw 3.

The data pulse that sends the communication information can be measured with a voltmeter placed to DCV range. From the ground connection at the Terminal Block to the Number 3 screw connection, the voltage should pulse up and down when data is being transmitted.

This control board has control over the fan louver movement, manual fan blower control, indoor coil temperature and indoor air temperature sensing functions. All operational decisions are controlled by the OUTDOOR UNIT ECU. The connections on the indoor indoor board are shown here in the schematic drawing.

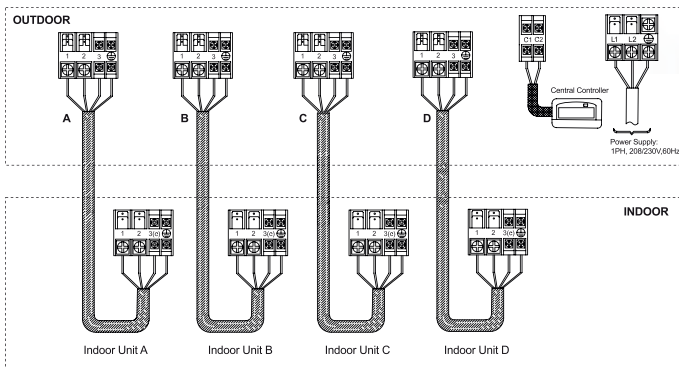

Line voltage to power the indoor unit comes in on Terminal Block connections 1 and 2. Power connects from these terminal connections to CN-52 and CN-21 on the circuit board. If the board does not respond to commands and has no display, check for line voltage at these connections. When power is present at the indoor board, the RED LED on the circuit board will blink a 2 flash code.

The control board has a replaceable 3.15A 250V fuse that protects against excessive current. If power is present at the board but the board does not work, check for continuity through the fuse. Replace if the fuse is open.

The indoor unit temperature sensors are connected at Plug CN6. When testing the calibration of these sensors, the wires can be released from the plug by pressing on the tension tab on the side of the plug.

The receiver/display unit that is mounted to the front cover of the indoor unit plugs into the circuit board via a connection at Plug CN-7.

There are two to three motors that control the movement of the louvers right, left and up/down. These motors connect at CN5, CN11 and CN10. Some units will use one motor to operate the right and left movement function.

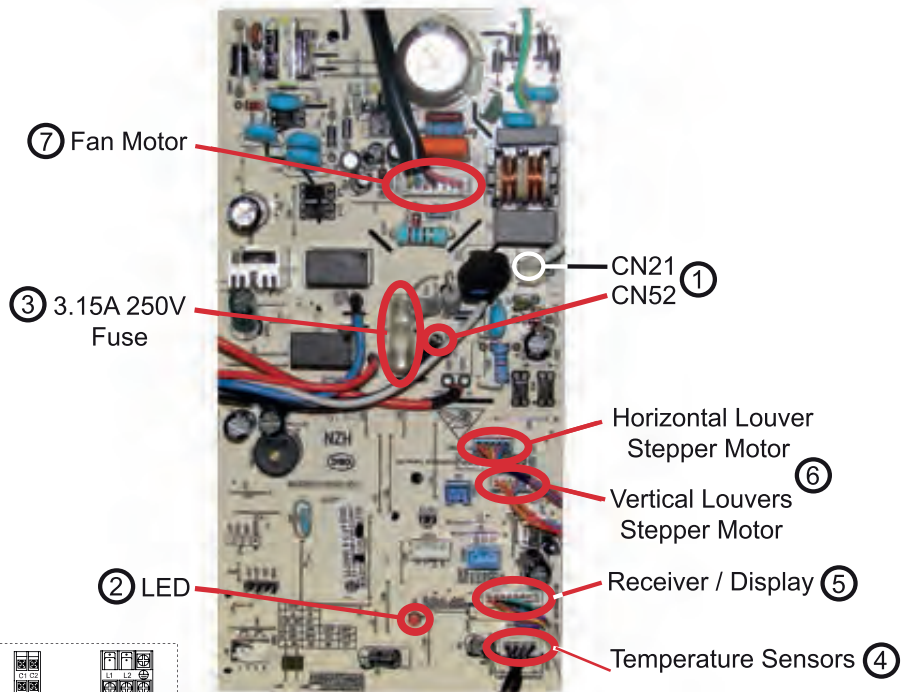

The blower motor is connected to the circuit board at plug CN-9.

There is an Emergency Run switch on the edge of the indoor board that will put the system into Auto Mode should the remote control break or be lost. When this switch is pressed and held for 5 seconds, the indoor unit display will beep twice and the system will enter TEST MODE.

The PCB for Flexfit-Multi-Zone series has a set of DIP switches that must be set when replacing the PCB. The replacement PCB is shipped with all switches set to the OFF position.

SW2-1 Selects remote code A or B. Normally set to the off position for code A operation.

If two indoor units are used in the same area and the user wishes to control them separately, switch SW2-1 of the second unit is set to the ON position for code B operation. The wireless remote for the second unit is also set to code B.

SW2-2 Selects room card able or disable. Normally set to the OFF position. Set to the ON position when used in conjunction with a room card interface utilized in hotel rooms.

SW-3&SW-4 Selects eeprom code 23 and 26. Set to identify the tonnage of the unit.

Settings:

AW24LP2VHA	(23)	SW-3	OFF	SW-4	OFF
AW36LP2VHA	(26)	SW-3	OFF	SW-4	ON

Display Switch Settings:

The PCB for the indoor unit of the Advanced series of single zone mini-splits has a set of Display switches that must be set when replacing the PCB.

The Display switches of FlexFit-Multi-Zone series don't cut, J46-ON, J45-ON

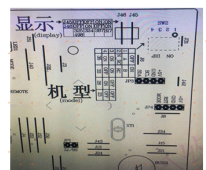

INDOOR WALL MOUNT UNIT TECHNICAL OVERVIEW

Blower Assembly

The **blower assembly** consists of a plastic blower wheel that is connected to a variable speed indoor blower motor. A set screw holds the blower wheel to the blower motor.



The indoor blower motor is a DC Fan Motor that is connected to the indoor unit control board via Plug CN-9. The wiring from the motor to indoor board consists of 5 wires connected to pins 1, 4, 5, 6 and 7. Pin 1 should have 310 VDC. Pin 4 is ground. Pin 5 +15VDC. Pin 6 is the feedback signal. Pin 7 is the speed control.

During normal operation, the indoor control board will energize the indoor blower motor and request proper speed. The indoor blower motor will control the speed via a command at the Pin 7 speed control. Proper fan speed is verified by the indoor control board via the voltage level at the feedback signal on Pin 6. Should the feedback signal not be present during a call for indoor blower, the indoor control board will indicate a Malfunction Code E14.

Louver motors

The **louver motors** are stepper type motors that move the louvers either right/left or up/down. The motors are controlled by pulsed voltage that cannot be measured. If the louver does not move when it should, check for a blockage in the louvers. If the louver is free to move, refer to the Test Procedure Section.

See A and B below.

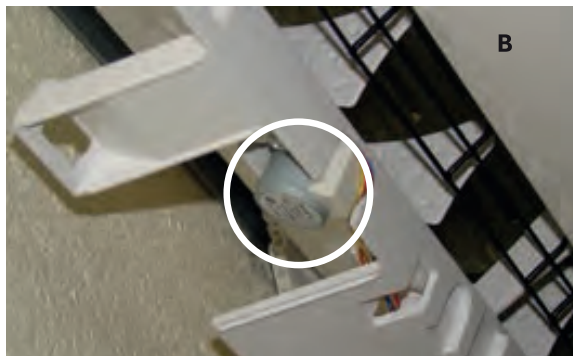
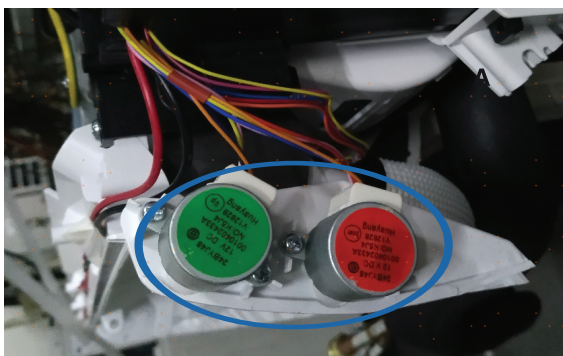

Temperature Sensors

The **Piping Temperature Sensor** senses indoor coil temperature in the cooling mode and in the heating mode. This sensor is used for Anti Freezing and Anti Cold Blow cycles. The sensor also provides critical temperature information to the ECU that may be used in frequency adjustments. See Temperature Sensor Functions.

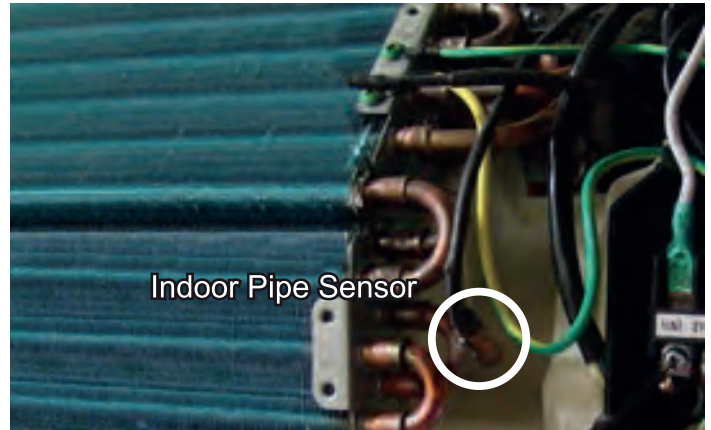

The **Ambient Temperature Sensor** senses room temperature. This sensor provides room temperature information to the ECU for calculation of inverter capacity and temperature control.

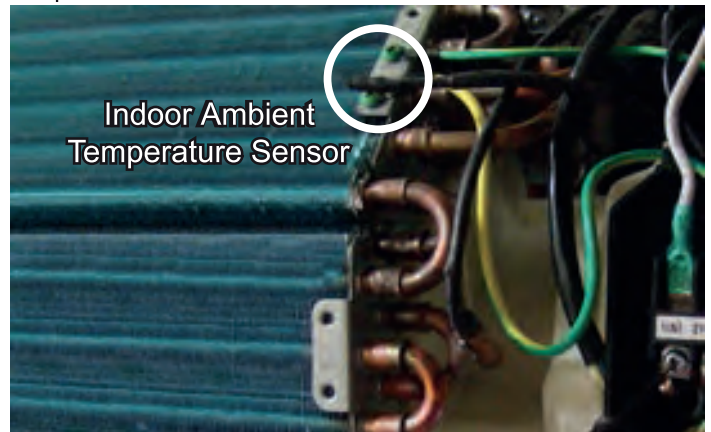

Both sensors are negative temperature coefficient type that reduce electrical resistance as temperature rises.

INDOOR WALL MOUNT UNIT TECHNICAL OVERVIEW

Test Procedures

Accessing components/removing cover

1. To access components for service, first disconnect power to the outdoor unit. This will de-energize the indoor unit.
2. Lift the front cover by prying on the two indented finger holds at each end of the indoor unit.



3. Remove the three Phillips head screws located near the bottom of the indoor unit. These screws are located directly below the bottom of the air filter.



4. Remove the filters.



5. Manually open the louver.



6. Open the 3 caps that cover the screws located behind the bottom of the louver. These caps flip up.



7. Remove the three screws located behind the caps.



8. Remove the two screws that hold the digital display to the front cover. The display can hang free.



9. Release the air temperature sensor from the clip that holds it.



10. Pull upward on the top of the indoor unit cover to free it from the four retaining clips. The cover will pivot downward. The cover should now pull away from the indoor unit.

INDOOR WALL MOUNT UNIT TECHNICAL OVERVIEW

Indoor Fan Motor Voltage Check

If the indoor fan motor does not run.

1. Remove the front cover and access the circuit board connection CN-9.
2. Reset power and turn the remote control fan command to Fan On mode.

Motor Test

1. If the motor doesn't run, check for 310VDC between Pins 1 and 3. If it is not present, the indoor board is bad. If voltage is present, continue on.
2. Check the voltage between Pins 3 and 4. The voltage should be +15VDC. If it is not present, the board is bad. If voltage is present, continue on.
3. Check for voltage between Pins 3 and 6. If no DC voltage is present, the board is bad. If voltage is present, change the motor.

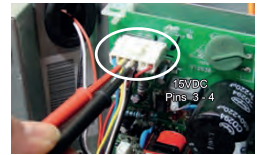
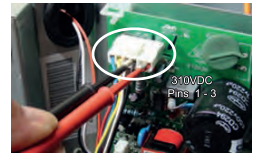

Replace the Blower Motor

Replace the Blower Motor

Step 1. Disconnect the power.

Step 2. With the indoor unit cover removed, remove the two screws on the left plastic evaporator coil bracket.



Step 3. Remove the cover from the electrical box on the right side of the indoor unit.



Step 4. Remove the two screws that hold the electrical box in place.



Step 5. Lift and swing the electrical box out of the way.



INDOOR WALL MOUNT UNIT TECHNICAL OVERVIEW

Step 6. Remove 6 screws that hold the motor bracket and evaporator coil.

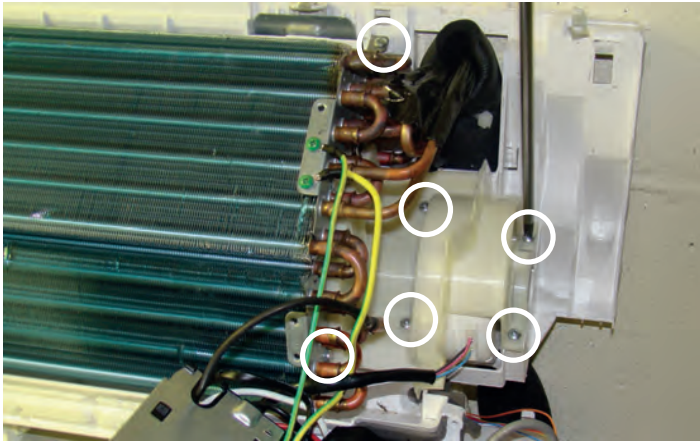

Step 7. Lift the evaporator coil and remove the motor bracket.

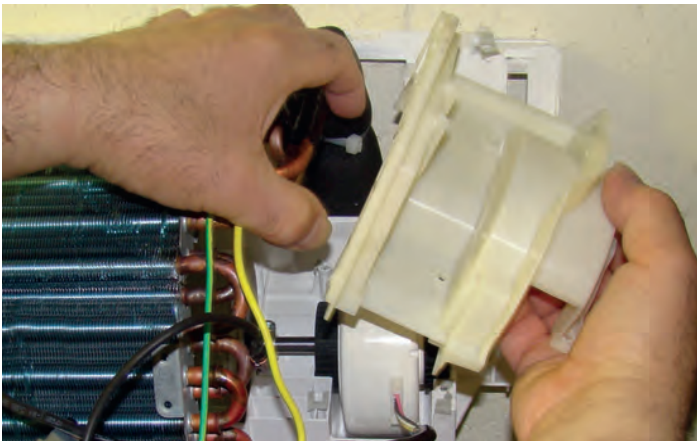

Step 8 Loosen the motor shaft set screw. Phillips head screw.



Step 9. Unplug the motor from the circuit board.

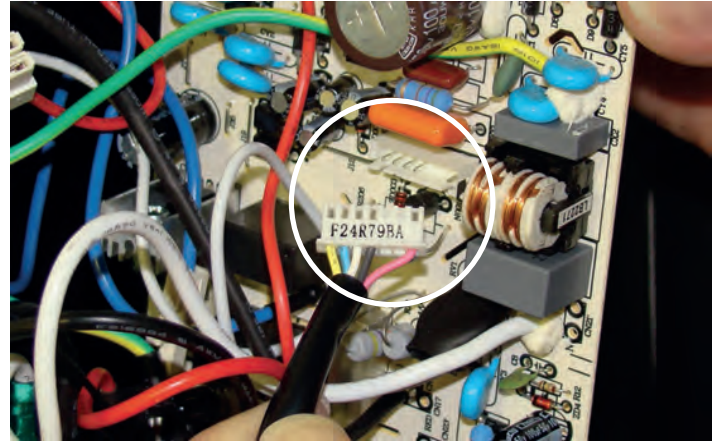

Step 10. Lift and slide the motor away from the blower wheel.



Step 11. Remove the two black anti vibration mounts from the defective motor and place them on the new motor.



Step 12 Install new motor in reverse order.

INDOOR WALL MOUNT UNIT SECTION

Testing Temperature Sensors and Louver Motors

Testing Temperature Sensors

The easiest problems to solve will involve codes that are related to potential failure of temperature sensors. Common problems may include loose connections, open electrically, and out of calibration. Checking the condition of the sensors requires a temperature probe and an ohmmeter.

The Reference Section of this manual contains temperature resistance tables that can be used to check the calibration of the sensors. The measured resistance must be within the tolerances printed on the top of the tables.

To test the electrical condition of a temperature sensor perform the following:

1. Confirm the sensor is firmly attached to the circuit board connection plug.
2. Remove the sensor wires from the connection plug by releasing holding tension on the plugs tension tab.
3. Use an ohmmeter to test the electrical resistance of the sensor.
4. Measure the air temperature near the sensor and compare the required resistance against measured resistance. (See chart in reference section) If the sensor is within calibration, the sensor is good. If the sensor is out of calibration, replace the sensor. (Tube Sensors should be removed from socket and exposed to air temperature during test.)

Testing Louver Motors

If the louver does not operate with command from the remote control, either the indoor board is bad, or the louver motor is defective. It is more likely the motor is defective than the board. (Make sure the louver assembly is not binding and keeping the vanes from moving.)

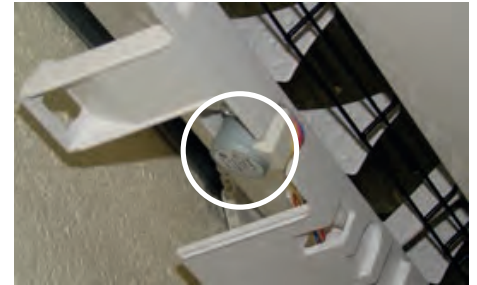

1. Remove power from the unit and remove the indoor unit cover.
2. Access the circuit board.

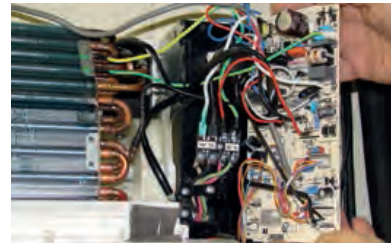

3. Identify on the schematic drawing the inoperable louver motor and disconnect the plug from the circuit board. (The up down louver motor is located on the right side of the indoor unit. The left right louver motor is located bottom center.)

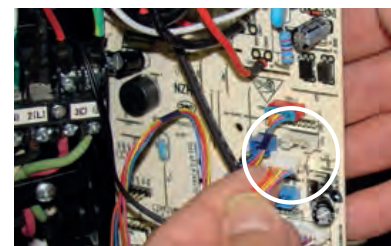

4. Use an Ohmmeter to test the electrical continuity of the louver motor windings. The proper resistance for each winding can be found in this table. If the motor winding resistance is erratic or shows open, the motor is defective. Replace the motor.

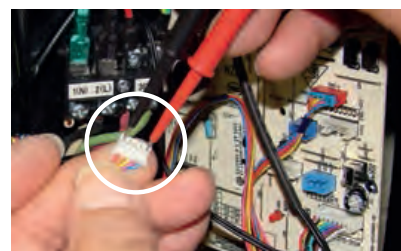

5. If the motor checks out good, replace the indoor control board.

INDOOR WALL MOUNT UNIT SECTION

Testing Communication Circuit

Testing Communication Circuit

If an Error E7 occurs, perform the following test to determine if the indoor control board is functioning properly to send data to the outdoor unit.

Perform this test with the unit powered and all wiring connected between indoor and outdoor unit.

Make sure all wiring between the indoor and outdoor unit are correct. There should be no splices between the indoor and outdoor unit wiring connecting terminals 1 or 3. Make sure wiring is correct, before performing this test.

1. Measure the DC voltage between terminals 1 and 3 on the indoor terminal block.

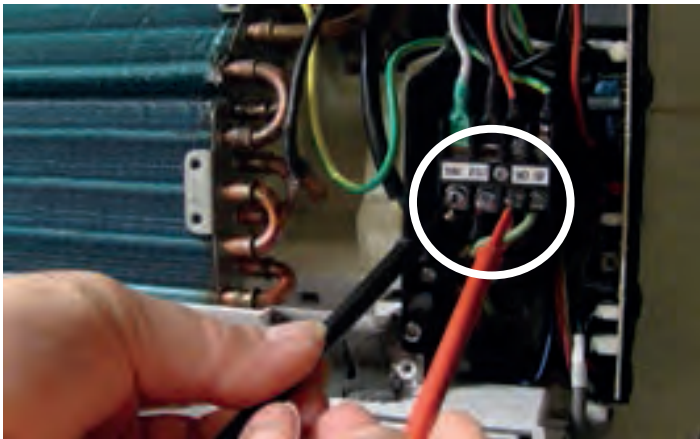

2. The voltage should fluctuate between 8VDC and 23VDC. The fluctuating signal indicates a good communication path.
3. If the voltage does not fluctuate, and the wiring is good, the indoor board is defective.

Antifreezing Protection

Antifreezing Protection

Prevents freeze-up of the indoor coil

The indoor unit coil temperature sensor will shut off the outdoor unit and begin a defrosting routine if the indoor coil is below 32°F for more than 2 minutes. The indoor unit will not report this operation. Once the indoor coil warms up, the system will re-enter cooling mode and operate normally. This protection cycle prevents the indoor coil from developing ice coating during low heat load operation.

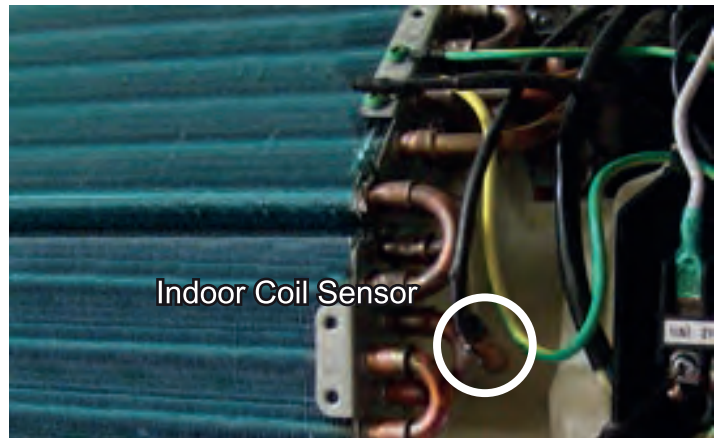

INDOOR WALL MOUNT UNIT

Indoor Unit Error Codes

Indoor Unit Error Codes (HSU218VHG Only)

The error codes that are displayed on the indoor units may vary from the outdoor unit codes. The information communicated by the error code will be the SAME for both indoor and outdoor units even though the numbers may differ.

Error Code E7

This code is indicating the indoor and outdoor units have lost communication signal. Check wiring between indoor and outdoor unit. Confirm 14 gauge AWG stranded wire present. Confirm no splices in wires 1 and 3. Go to Test Procedures to solve communication error.

Error Code E1

This code indicates a failure of the room temperature sensor. Go to Test Procedure section to solve.

Error Code E2

This code indicates a failure of the Pipe Temperature Sensor on the indoor unit. Go to Test Procedure section to solve.

Error Code E4

This error indicates an EEPROM Error indoor unit control board. Reset power. If error repeats, replace the indoor circuit board.

Error Code E14

This code indicates the indoor fan motor failed to run. Go to Test Procedure Section to solve.

Error Code F12

This code indicates an OUTDOOR UNIT EEPROM error. Cycle power. If the error does not clear, replace the ECU.

Error Code F1

The module board detected excessive instantaneous current compressor, IPM hardware automatically stopped the Module Board output to protect the compressor.

Potential causes include:

- overcharge
- dirty outdoor coil
- hot conditioned space temperature/high load

- refrigeration circuit restriction
- seized compressor
- Bad Module Board

Error Code F22

Compressor current abnormal: module driver board detected that the compressor current is too large, The Module board software protects it and the compressor.

Possible Causes:

- overcharge
- dirty outdoor coil
- hot conditioned space temperature/high load
- refrigeration circuit restriction
- seized compressor
- Bad Module Board

Error Code F3

This code indicates the Module board is not communicating with the ECU. Check the wiring Plug connection between the two control boards. Make sure the connection is tight. The Module Plug connection is Plug CN-9 and the ECU plug is also Plug CN-9. If the connection is good, yet the boards do not communicate and the code will not clear, replace the MODULE Board.

Error Code F19

This code indicates the operating voltage of the system is either too high or too low. Check line voltage for proper limits. The line voltage supplied to the outdoor unit should be now lower than 187V when the compressor starts. The running voltage should be no lower than 197V. The incoming line voltage to the outdoor unit should never be higher than 253V. If improper voltage is present, check the supply voltage circuit from the building for proper size wiring and good connections. If the voltage is still outside operating limits, contact the power company to have the service corrected.

If the line voltage from the power company is correct, check the output voltage of the Power Circuit Board. This voltage connects to the MODULE board at terminals CN-1 and CN-2. If the voltage is not within specifications shown above, replace the Power Circuit Board.

Error Code F27

This error code indicates the compressor failed to start when a call for operation occurred. Refer to the Test Procedure for Compressor troubleshooting to diagnose the problem.

INDOOR WALL MOUNT UNIT

Indoor Unit Error Codes

Error Code F4

This code indicates the temperature of the compressor hot gas is too high. This error would have occurred despite the ECU attempt at reducing operating frequency. Causes of this type of condition are typically a lack of refrigerant in the system, excessive heat in the conditioned space or a restriction in the refrigeration circuit.

Error Code F8

This code indicates the outdoor fan motor is not running. The fault is detected very quickly by the ECU. The system will shut off and display this error code. If this error occurs, reference the Test Procedure for Outdoor Fan Motor.

Error Code F21

This code indicates an electrical failure of the sensor that is used to sense the temperature of the outdoor coil during heat mode operation. This sensor is connected to the ECU via a connection at Plug CN-14.

Error Code F7

This code indicates an electrical failure of the sensor that is used to sense the temperature of the suction gas that enters the compressor. The sensor is connected to the ECU via two wires at Plug CN-14.

Error Code F6

This code indicates an electrical failure of the sensor that is used to sense the temperature of the outdoor air. The sensor is connected to the ECU via two wires at Plug CN-14.

Error Code F25

This code indicates an electrical failure of the sensor that is used to sense the temperature of the compressor hot gas discharge line. The sensor is connected to the ECU via two wires at Plug CN-14.

Error Code F13

The system is low on refrigerant charge. Correct leak and recharge per installation instructions in Reference Section.

Error Code F11

Recycle power and restart the system. If the compressor initially starts but then stops, replace the MODULE board and COMPRESSOR.

Error Code F28

Recycle power and restart the system. If the compressor initially starts but then stops, replace the MODULE board and COMPRESSOR.

Error Code F2

The current draw into the compressor is too high. Check compressor windings. If OK, replace the Module Board.

Error Code F23

The current draw into the compressor is too high. Check compressor windings. If OK, replace the Module Board.

Error Code E9

This error indicates the temperature of the indoor coil during heating mode is too high and has exceeded the maximum limit. This code will be indicated when the temperature of the indoor coil exceeds 149 F twice in 30 minutes. Causes include low charge, dirty indoor coil, faulty EEV

Important Service Related Installation Information

Indoor Clearances: If non-compliant may lead to temperature control complaints.

Wire Sizing: If non-compliant may lead to communication errors and inverter irregular operation.

Splices in Field Wiring: Splices between the wires that connect between the outdoor and indoor unit should be avoided. Communication errors may occur if non compliant.

Sealing Penetrations: If penetrations at back of unit are not sealed, unconditioned air may be drawn into the back of the indoor wall mount unit. Temperature control and capacity complaints may occur.

INDOOR WALL MOUNT UNIT

Connection method for one wired controller with multiple Wall Mount

Alert! Ensure do any of the operating during power off.

The wired remote can connect up to 16 indoor units at the same time, but each high wall indoor request 1 wired controller kit WK-B. Up to 16 indoor units can be connected by the wired remote at the same time, but each one requests 1 wired controller kit WK-B.

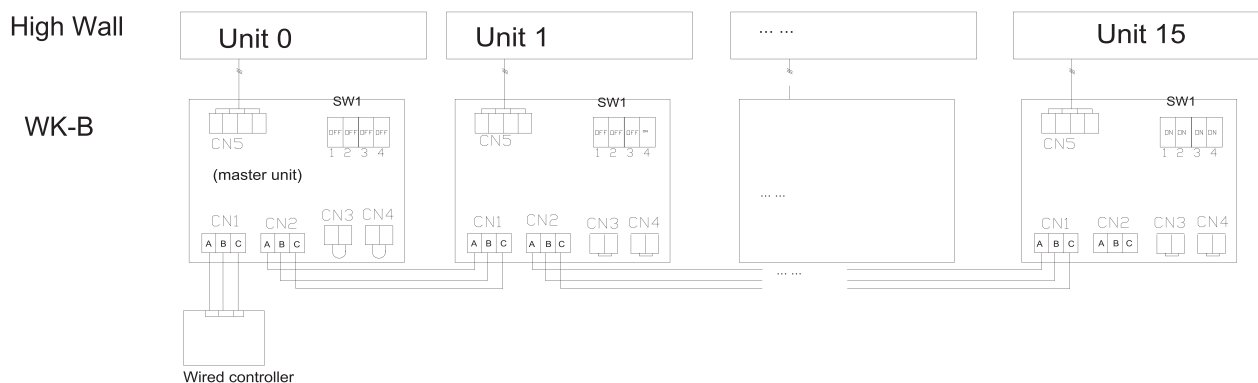
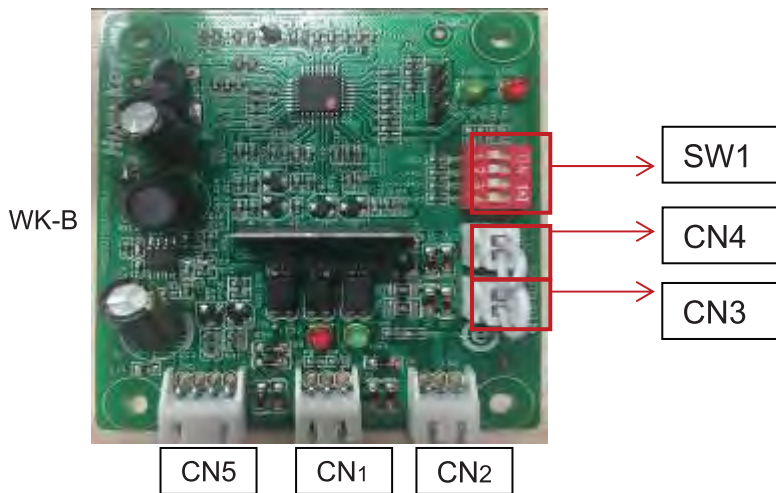
**Remark:**

- (1) The first high wall indoor unit to connect with WK-B is considered as master unit 0.
- (2) There is a jumper between terminal CN3 and CN4 on the WK-B.
 - For the master unit, please keep the jumper
 - For slave unit(s), please remove the jumper.
- (3) The terminal CN1 of WK-B for master unit (unit 0) must connect the wired remote.
- (4) The terminal CN2 of WK-B for master unit (unit 0) must connect the CN1 of WK-B for slave unit (unit 1), and the terminal CN2 of WK-B for slave unit #1 will need to be connect to terminal CN1 of WK-B for the next slave unit.
- (5) Please see the attached list for Master/slave DIP switch setting of WK-B.

INDOOR WALL MOUNT UNIT

Connection method for one wired controller with multiple Wall Mount

Unit No.	Dip Switch Position of of WK-B			
	1	2	3	4
0	OFF	OFF	OFF	OFF
1	OFF	OFF	OFF	ON
2	OFF	OFF	ON	OFF
3	OFF	OFF	ON	ON
4	OFF	ON	OFF	OFF
5	OFF	ON	OFF	ON
6	OFF	ON	ON	OFF
7	OFF	ON	ON	ON
8	ON	OFF	OFF	OFF
9	ON	OFF	OFF	ON
10	ON	OFF	ON	OFF
11	ON	OFF	ON	ON
12	ON	ON	OFF	OFF
13	ON	ON	OFF	ON
14	ON	ON	ON	OFF
15	ON	ON	ON	ON

Part 3 Indoor Units--4-Way Cassette Type

1. Features	20
2. Specifications	21
3. Dimensions.....	24
4. PCB Configuration.....	25
5. Air Velocity and Temperatures	26
6. Installation	30

1. Feature

Stylish Grille Design "Spiral" panel

Spiral panel concept is a Haier exclusive.



Full-closing Panel

Flap is hidden during the off cycle for an attractive look and low energy loss.



ABS Panels

Bright white color won't yellow over time.



New designed fan

This is already in the OD section. Eliminate or change picture and text.



Individual Flaps

Control all four independently to provide maximum comfort and air movement.

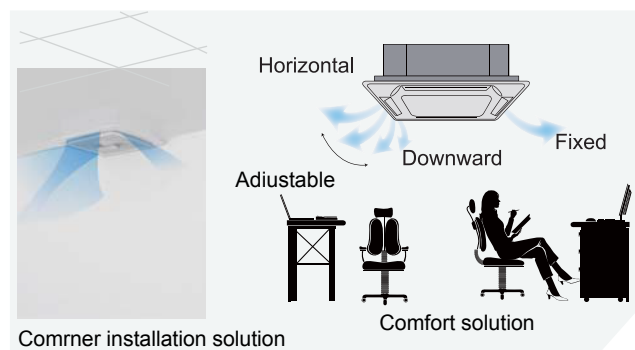

2. Specifications

Model Name	System	AL24LP
	Outdoor	1U24LP2VHA
	Indoor	AL24LP2VH*
Cooling	Rated Capacity Btu/hr	24000
	Capacity Range Btu/hr	6800-27000
	Rated Power Input W	2,087
	SEER	17
	EER	11.5
	Moisture Removal Pt./h	5.1
Heating	Rate Heating Capacity 47°F Btu/hr	27300
	Heating Capacity Range Btu/hr	6800-30500
	Rated Power Input W	2,281
	HSPF	10
Operating Range	Cooling °F(°C)	0~115F(-18-46C)*
	Heating °F(°C)	-4°F~75°F (-20-24°C)
Power Supply	Voltage, Cycle, Phase V/Hz/-	208-230/60/1
Outdoor Unit	Compressor Type	DC Inverter Driven Rotary
	Maximum Fuse Size A	25.0
	Minimum Circuit Amp A	21.0
	Outdoor Fan Speed RPM	750/700/650/600/500/400/300
	Outdoor Noise Level dB	47
	Dimension: Height in (mm)	38 (965)
	Dimension: Width in (mm)	37 3/8(950)
	Dimension: Depth in (mm)	14 5/8(370)
Weight (Ship/Net)- lbs (kg)	202.8/ 176.4 (92/80)	
Indoor Unit	Fan Speed Stages	4 + Auto
	Airflow (Turbo/High/Med/Low/Quiet) CFM	740/630/480/400
	Motor Speed (Turbo/High/Med/Low/Quiet) RPM	500/400/300/250
	Indoor Sound Level dB (Turbo/High/Med/Low/Quiet)	36/33/29/26
	Dimension: Height in (mm)	9 5/8 (246)
	Dimension: Width in (mm)	33 1/8(840)
	Dimension: Depth in (mm)	33 1/8(840)
	Max. External Static Pressure in.W.G(Pa)	NA
	Drainpipe Size O.D. in	1 1/4
	Internal Condensate Pump	Standard
	Max. Drain-Lift height in(mm)	39 3/8 (1000)
	Grill Model	PB-950KB
	Grill Dimension: Height in (mm)	2 (50)
	Grill Dimension: Width in (mm)	37 3/8 (950)
	Grill Dimension: Depth in (mm)	37 3/8 (950)
Weight (Ship/Net)- lbs (kg)	79.4/68.3 (36/31)	
Refrigerant Lines	Connections	Flare
	Liquid O.D. in	3/8
	Suction O.D. in	5/8
	Factory Charge Oz	88.2
	Maximum Line Length Ft / m	165/50
	Maximum Height Ft / m	100/30

Model Name	System	AL36LP
	Outdoor	1U36LP2VHA
	Indoor	AL36LP2VH*
Cooling	Rated Capacity Btu/hr	35000
	Capacity Range Btu/hr	8500-37500
	Rated Power Input W	3,500
	SEER	17
	EER	10
	Moisture Removal Pt./h	6.3
Heating	Rate Heating Capacity 47°F Btu/hr	36500
	Heating Capacity Range Btu/hr	8500-38500
	Rated Power Input W	3,253
	HSPF	10.3
Operating Range	Cooling °F(°C)	0~115F(-18-46C)*
	Heating °F(°C)	-4°F~75°F (-20-24°C)
Power Supply	Voltage, Cycle, Phase V/Hz/-	208-230/60/1
Outdoor Unit	Compressor Type	DC Inverter Driven Rotary
	Maximum Fuse Size A	30
	Minimum Circuit Amp A	26.0
	Outdoor Fan Speed RPM	750/700/650/600/500/400/300
	Outdoor Noise Level dB	52
	Dimension: Height in (mm)	38 (965)
	Dimension: Width in (mm)	37 3/8(950)
	Dimension: Depth in (mm)	14 5/8(370)
Weight (Ship/Net)- lbs (kg)	207.2/180.7 (94/82)	
Indoor Unit	Fan Speed Stages	4 + Auto
	Airflow (Turbo/High/Med/Low/Quiet) CFM	990/900/776/700
	Motor Speed (Turbo/High/Med/Low/Quiet) RPM	650/550/450/400
	Indoor Sound Level dB (Turbo/High/Med/Low/Quiet)	45/42/38/34
	Dimension: Height in (mm)	9 5/8 (246)
	Dimension: Width in (mm)	33 1/8(840)
	Dimension: Depth in (mm)	33 1/8(840)
	Max. External Static Pressure in.W.G(Pa)	NA
	Drainpipe Size O.D. in	1 1/4
	Internal Condensate Pump	Standard
	Max. Drain-Lift height in(mm)	39 3/8 (1000)
	Grill Model	PB-950KB
	Grill Dimension: Height in (mm)	2 (50)
	Grill Dimension: Width in (mm)	37 3/8 (950)
	Grill Dimension: Depth in (mm)	37 3/8 (950)
Weight (Ship/Net)- lbs (kg)	79.4/68.3 (36/31)	
Refrigerant Lines	Connections	Flare
	Liquid O.D. in	3/8
	Suction O.D. in	5/8
	Factory Charge Oz	88.2
	Maximum Line Length Ft / m	165/50
	Maximum Height Ft / m	100/30

Model Name	System	AL48LP
	Outdoor	1U48LP2VHA
	Indoor	AL48LP2VH*
Cooling	Rated Capacity Btu/hr	45000
	Capacity Range Btu/hr	11900-52800
	Rated Power Input W	4,286
	SEER	17
	EER	10.5
	Moisture Removal Pt./h	11.0
Heating	Rate Heating Capacity 47°F Btu/hr	49000
	Heating Capacity Range Btu/hr	13600-61000
	Rated Power Input W	4,533
	HSPF	10.5
Operating Range	Cooling °F(°C)	0~115F(-18-46C)*
	Heating °F(°C)	-4°F~75°F (-20-24°C)
Power Supply	Voltage, Cycle, Phase V/Hz/-	208-230/60/1
Outdoor Unit	Compressor Type	DC Inverter Driven Rotary
	Maximum Fuse Size A	40
	Minimum Circuit Amp A	35.0
	Outdoor Fan Speed RPM	750/700/650/600/500/400/300
	Outdoor Noise Level dB	53
	Dimension: Height in (mm)	53 1/8 (1350)
	Dimension: Width in (mm)	37 3/8(950)
	Dimension: Depth in (mm)	14 5/8(370)
	Weight (Ship/Net)- lbs (kg)	260.1/231.5 (118/105)
Indoor Unit	Fan Speed Stages	4 + Auto
	Airflow (Turbo/High/Med/Low/Quiet) CFM	1147/941/847/705
	Motor Speed (Turbo/High/Med/Low/Quiet) RPM	750/650/500/400
	Indoor Sound Level dB (Turbo/High/Med/Low/Quiet)	41/36/33/31
	Dimension: Height in (mm)	11 3/8 (288)
	Dimension: Width in (mm)	33 1/8(840)
	Dimension: Depth in (mm)	33 1/8(840)
	Max. External Static Pressure in.W.G(Pa)	NA
	Drainpipe Size O.D. in	1 1/4
	Internal Condensate Pump	Standard
	Max. Drain-Lift height in(mm)	39 3/8 (1000)
	Grill Model	PB-950KB
	Grill Dimension: Height in (mm)	2 (50)
	Grill Dimension: Width in (mm)	37 3/8 (950)
	Grill Dimension: Depth in (mm)	37 3/8 (950)
	Weight (Ship/Net)- lbs (kg)	83.8/70.5 (38/32)
Refrigerant Lines	Connections	Flare
	Liquid O.D. in	3/8
	Suction O.D. in	5/8
	Factory Charge Oz	131
	Maximum Line Length Ft / m	230/75
	Maximum Height Ft / m	100/30

3. Dimensions

AL24LP2VHA AL36LP2VHA

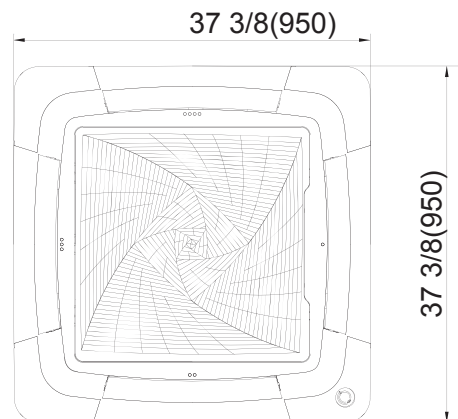
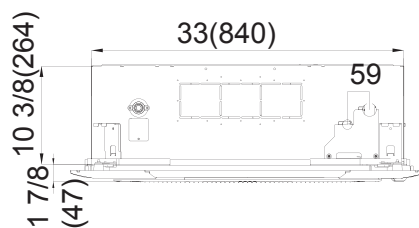
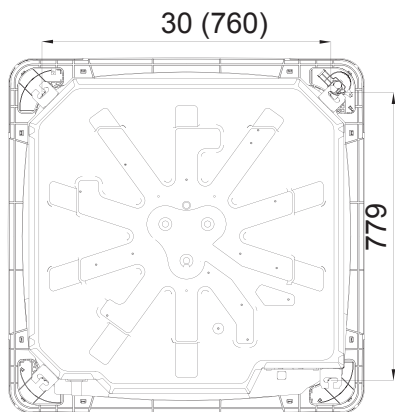

AL48LP2VHA

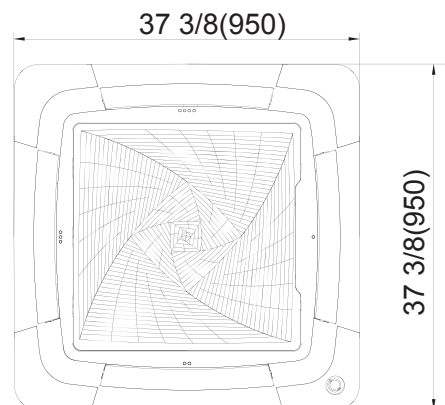
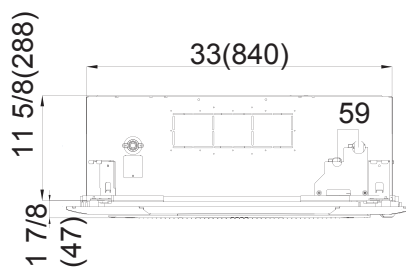
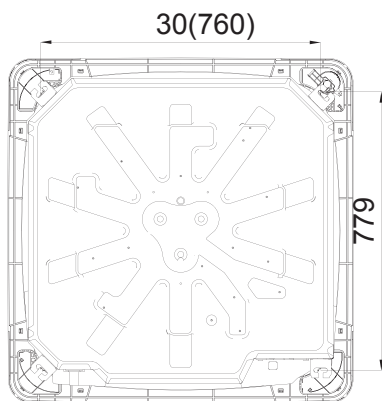

4. PCB Configuration

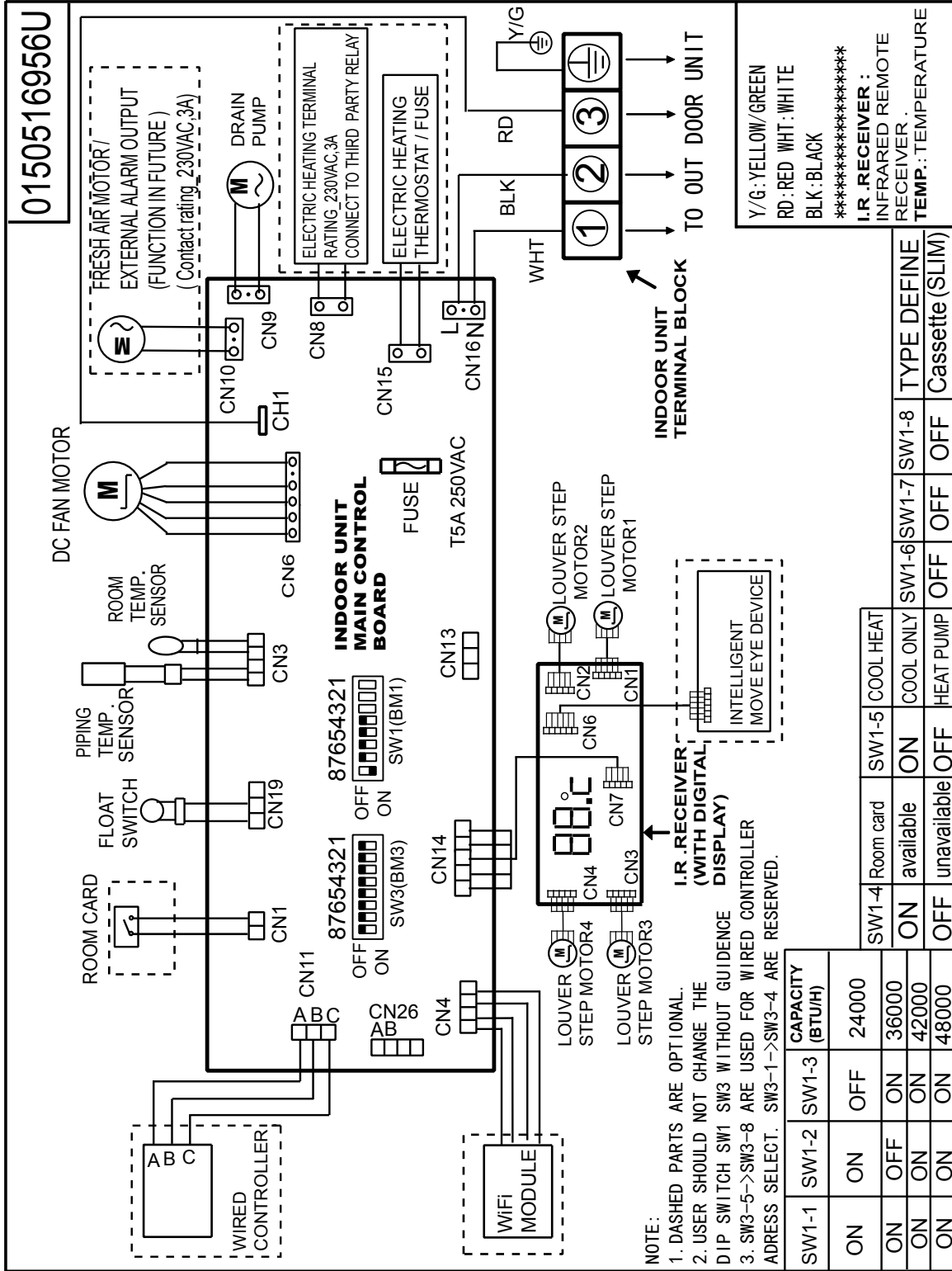

5. Air velocity and temperature distribution

AL24/36LP2VHA:

a. Cooling and air velocity

Cooling

33 degree flap angle

Air velocity distribution

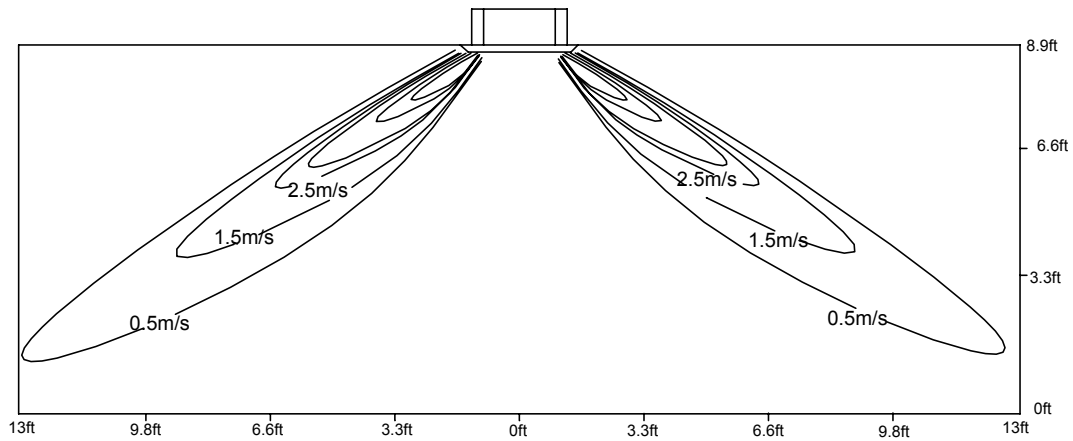

b. Cooling and temperatures

Cooling

33 degree flap angle

Temperature distribution

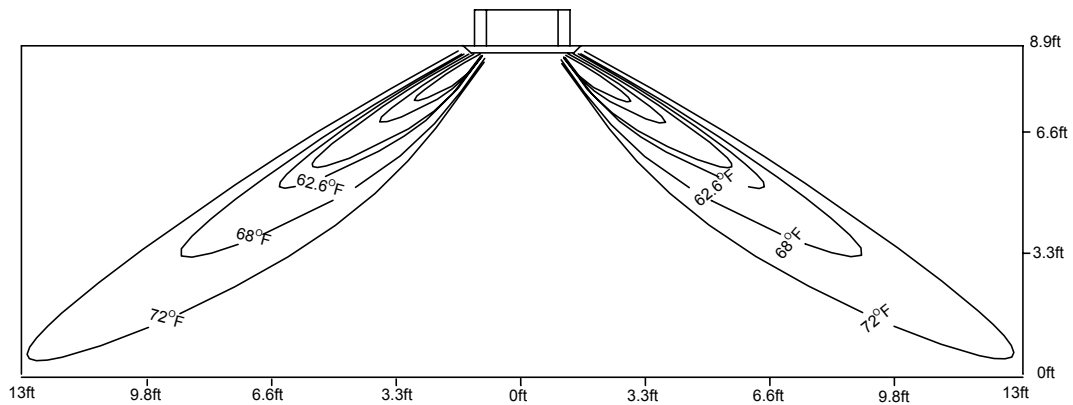

c. Heating and air velocity

Heating

60 degree flap angle

Air velocity distribution

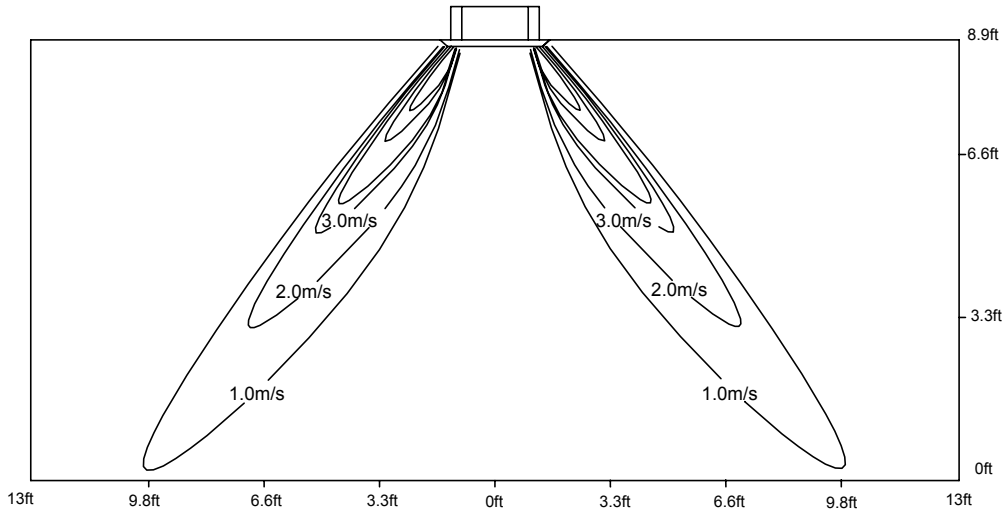

d. Heating/Temperature distribution

Heating

60 degree flap angle

Temperature distribution

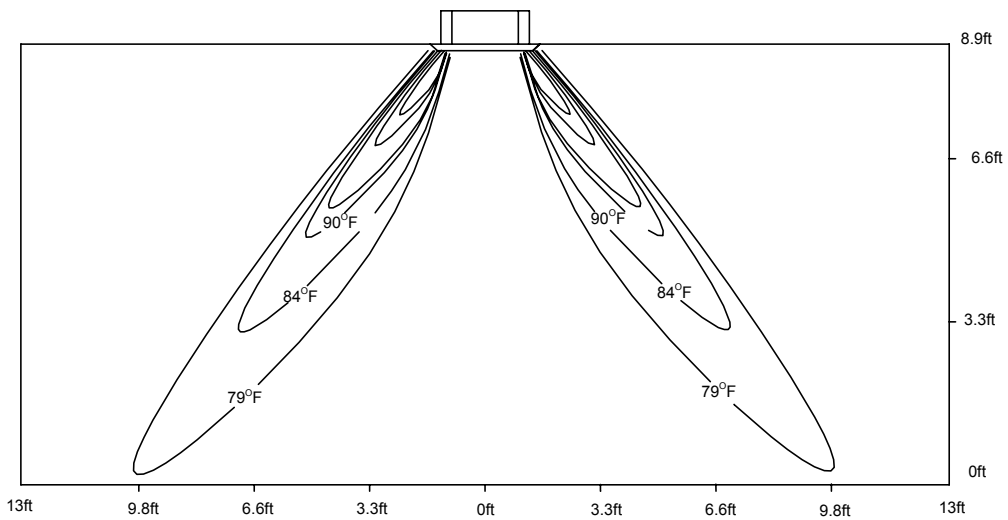

AL48LP2VHA

a. Cooling and air velocity

Cooling

33 degree flap angle

Air velocity distribution

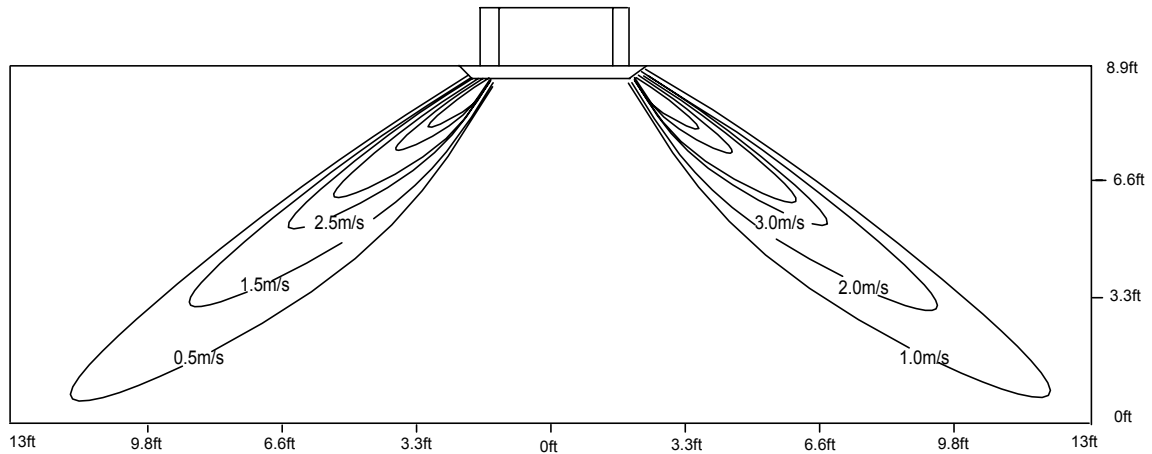

b. Cooling and temperatures

Cooling

33 degree flap angle

Temperature distribution

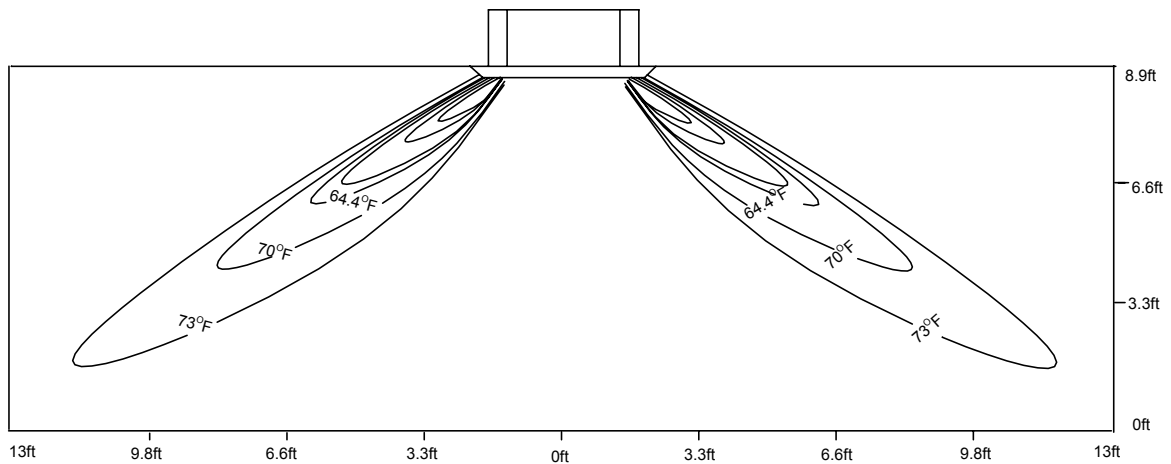

c. Heating and air velocity

Heating

60 degree flap angle

Air velocity distribution

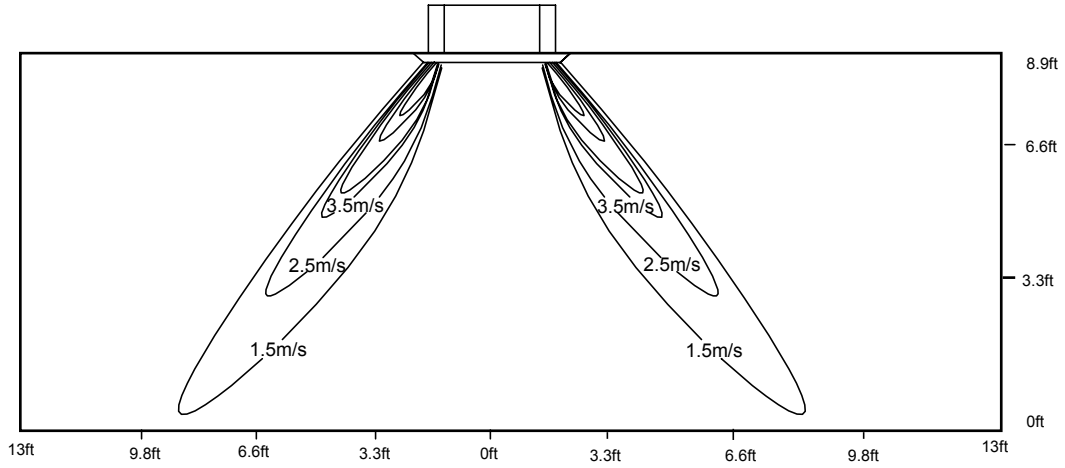

d. Heating and temperatures

Heating

60 degree flap angle

Temperature distribution

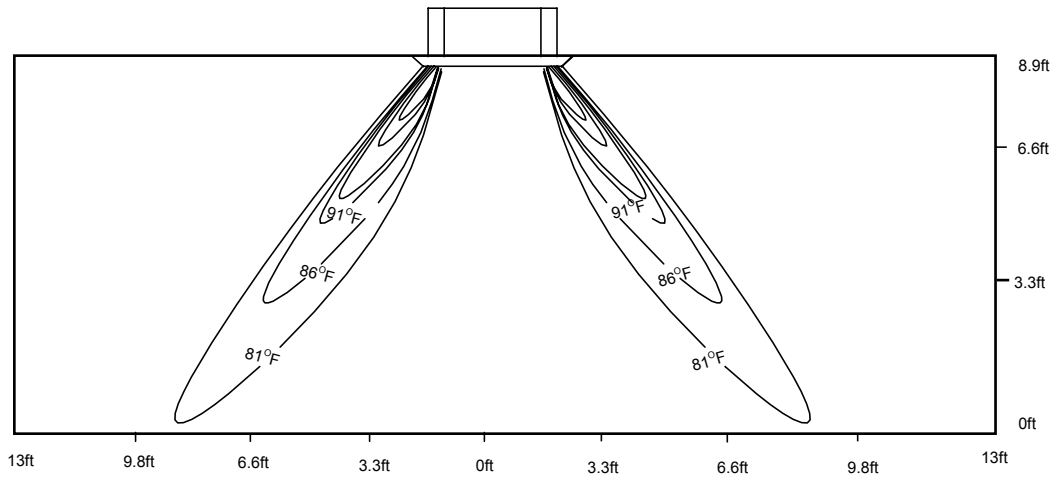

6. Installation

The Cassette Indoor Air Handler ships consisting of a cassette assembly and operational louver. The Cassette Indoor Unit is operated via a factory supplied remote control. Wired controller is optional.

The Cassette unit will install between standard dropped ceiling grids. It is mounted using threaded rods that fit into brackets that are located at all four corners of the cassette assembly.

The Cassette unit receives 230 volt line voltage from a connection at the outdoor condensing unit. There is no requirement for independent line voltage connections.

The cassette unit has a built in condensate pump and associated float switch that manages the operation of the condensate pump. A flexible hose is included with the Cassette unit. This hose connects the cassette condensate drain outlet to the buildings condensate drain system.

The motorized louver is controlled via the remote control. The louver has indicator lights that communicate function and diagnostic information to the user and service technician.

Optional fresh air can be piped into the cassette assembly. The knockout is located on the side of the cassette assembly. If fresh air is desired, be certain to filter the air prior to it entering the cassette. A 4" galvanized pipe should be used to pipe in the fresh air.

Included with the cassette unit is factory provided insulating tape. This tape should be placed over the refrigerant piping



Fresh Air Intake Option

The cassette has a marked area to cut out if outside air is desired. The piping connection should be made with a 4 inch diameter pipe. Outside air should be pre-filtered prior to entry in to the cassette.



Condensate Handling

The Cassette unit has a built in condensate pump and water level safety switch. There is no option for gravity drain. The condensate pump is rated to lift water up to 24" from the point of discharge on the cassette assembly.



Electrical Power

Follow all local codes and regulations when installing electrical wiring.

Route required electrical power to area where cassette is to be located. Maintain at least a 10 foot separation between TV and Radio wiring and the power to the indoor unit.

14 /4 AWG stranded wire should be used to make the electrical connection between indoor and outdoor units. This wiring will serve to power the indoor unit and establish a communication link between indoor and outdoor units.

The wiring is connected at the indoor unit electrical terminal blocks screws 1, 2, 3 and ground. There should be no splices in the wires connected to terminals 1 or 3 as these serve as communication signal wires and electrical power connections. If a safety switch needs to be in place to shut off power to the indoor unit, break wire 2 only.

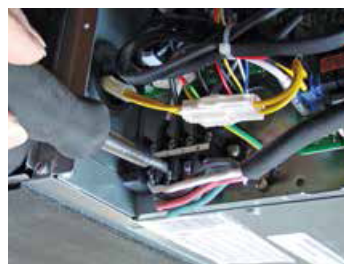

The cassette unit comes with a grey connection hose with clamp. This hose is connected to the cassette assembly discharge hose port. The other end of the hose is sized to accept 3/4" PVC piping.



Recommended condensate piping configurations are shown here:

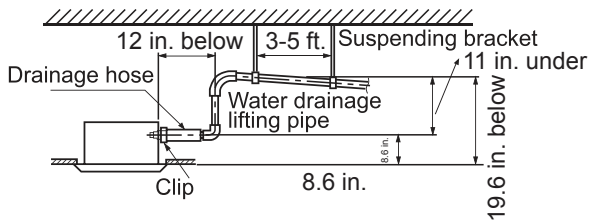

Air Delivery Clearances

Be certain to maintain proper clearances around the cassette as specified in the installation instructions. Standard clearances for cassette air handlers require 5 feet of clearance in each direction. There should be 8 feet of clearance from the face of the cassette louver to the floor. Inadequate clearances can cause system freezing and temperature control problems.

Service and Maintenance Clearances

Make sure there are adequate clearances for future maintenance and service. Allow enough room to access the condensate pump assembly and the electrical control box.

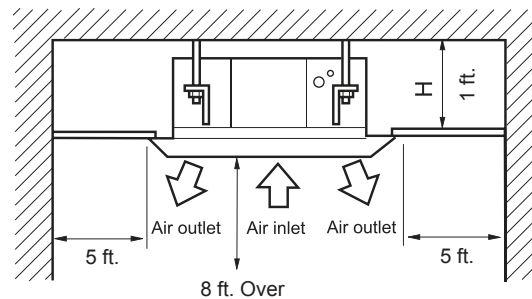

Step 1 - Preparation

Required Tools for Installation

- Drill
- Wire Snipper
- Hole Saw 2 3/4"
- Vacuum pump
- Soap-and-water solution or gas leakage detector
- Torque wrench
- 17mm, 22mm, 26mm
- Tubing cutter
- Flaring tool
- Razor knife
- Measuring tape
- Level
- Micron gauge
- Nitrogen
- Mini-Split AD-87 Adapter (1/4" to 5/16")
- A - Non-adhesive Tape
- B - Adhesive Tape
- C - Saddle (L.S.) with screws
- D - Electrical wiring
- E - Drain hose (Included)
- F - Insulation
- G - Piping hole cover (Included)

Procedure for Selecting the Location

- Place above the ceiling where you have enough space to position the unit.
- Place where the drainage pipe can be properly positioned.
- Place where the inlet and outlet air of the indoor unit will not be blocked.
- Do not install the unit in a place with heavy oil or moisture (e.g. - kitchens and workshops)
- Do not install in a location with destructive gas (such as sulfuric acid gas) or pungent gas (thinner and gasoline) are used or stored.
- Choose a place solid enough to bear the weight and vibration of the unit and where the operation noise will not be amplified.
- Install where there are no expensive items like a television or piano below the indoor unit.
- Leave enough space for maintenance.
- Install at least 3 ft. away from televisions and radios to avoid interference.

Note:

- 1) R-410A refrigerant is a safe, nontoxic and nonflammable refrigerant. However, if there is a concern about a dangerous level of refrigerant concentration in the case of refrigerant leakage, add extra ventilation.

Threaded Rod Mounting Information

The Cassette unit should be mounted to the building structure using threaded rods. The threaded rods should have washers and nuts to allow the height and level of the cassette to be adjusted.

The threaded rods and attachment brackets are field supplied items. The materials required for mounting to the brackets on the cassette assembly include:

- 4- 3/8" Threaded Rods
- 4- Mounting Brackets
- 8- Washers
- 8- Nuts (Double nut the assembly as shown)

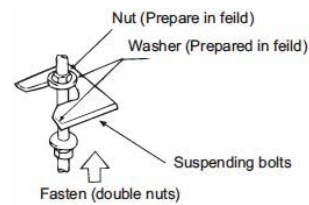
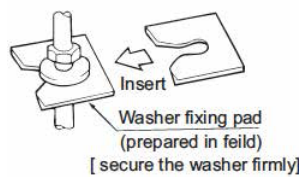
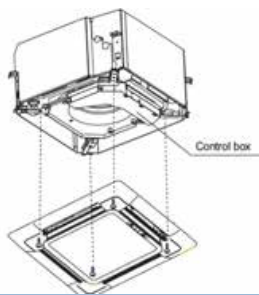

Step 2 - Installation of the Cassette Unit

Step By Step Guide To Cassette Installation

2.1 Step 2.1

Use cardboard template to locate center point of cassette for mounting. Use a plumb bob and string to position cassette by referencing center hole of template. Mark the mounting positions of the threaded rods using the guides on the cardboard template.

2.2 Step 2.2

Install threaded rods to structure using appropriate fasteners.

2.3 Step 2.3

Lift the cassette and position the threaded rods into the 4 mounting clips on each corner of the cassette unit.

2.4 Step 2.4

Using a level, adjust the nuts on the threaded rods to obtain a level reading across the bottom of the cassette unit.

2.5 Step 2.5A & 2.5B

Prior to routing the refrigerant lines to the unit, install the supplied flare nuts onto the refrigerant lines. Using a flaring tool, flare the refrigerant lines. Remove the caps attached to the ends of the refrigerant line connections at the cassette. Holding charge will be released.

Step 2.1



Step 2.2

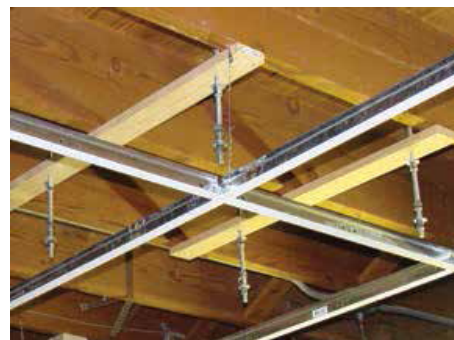

Using a torque wrench, torque the fittings to the proper specifications. (See Outdoor Unit Section for flare torque settings.)

2.6 Step 2.6

Connect the grey flexible drain hose supplied with the cassette unit to the condensate pump discharge pipe of the cassette. Tighten the clamp securely. Using 3/4 " PVC, connect the flexible hose to the building's condensate drain system.

2.7 Step 2.7

Remove the electrical box cover. Remove the rubber grommet and insert a 1/2 inch electrical connector and reducing washer. Route electrical wiring into cassette unit. Connect to wire terminas as indicated in schematic drawing. (USE 14 AWG Stranded wire only.)

2.8 Step 2.8A & 2.8B ,C, D

Connect Louver assembly to cassette assembly. Connect wires from louver to the harness on the cassette assembly. There are two wire connections. (See photo for connections.) Secure louver with four screws.

Reinstall electrical box cover.
Install return air grille into louver assembly.

Installation is now complete.

Step 2.3



Step 2.4



Step 2 - Installation of the Cassette Unit

Step 2.5A



Step 2.8A



Step 2.5B

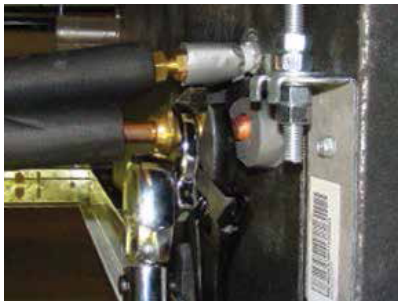

Step 2.8B

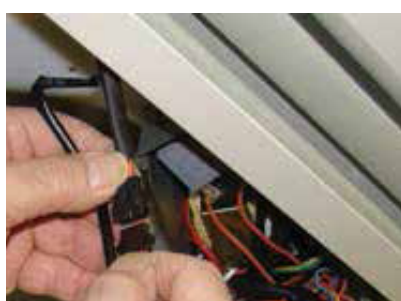

Step 2.6



Step 2.8C



Step 2.7

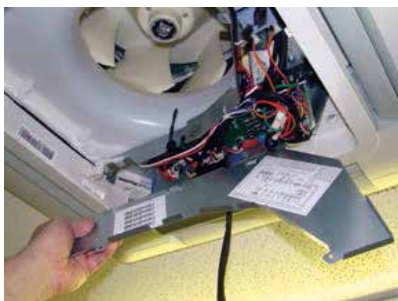

Step 2.8D



Step 3 - Electrical Connections

Electrical Connections Indoor and Outdoor Units

14 AWG Stranded Wire Only. (Central Controller Not Used)

Maintain 10 feet of separation between TV and any Radio wiring.

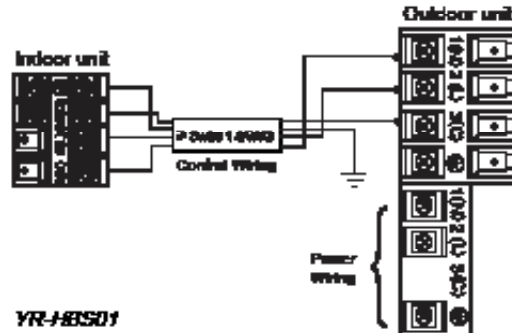

Note: Cassette unit ships with YR-HBS01 remote controller. See Section F for more information.

Step 4 - Louver Installation

To mount the louver cover onto the cassette assembly, install 2 screws at the keyhole slot positions shown in the first photo. Place louver onto the 2 screws and press louver onto cassette housing. Swing hang clip into position. (White circle.) Install remaining 2 screws and tighten the 4 screws. Connect electrical plugs to socket shown below. Install the electrical cover box and then snap the return air grille into position.



Step 5 - Pull Vacuum on System

See Step 3.2 of the outdoor unit installation section for how to pull a vacuum.

Part 4 Indoor Units-High Static Duct Type

1. Features	37
2. Specifications	38
3. Dimensions.....	41
4. Wiring diagrams	43
5. Instalaltion	45

1. Features

High Efficiency

DC Fan Motor

Achieves higher efficiency as compared to a conventional AC motor. See chart.

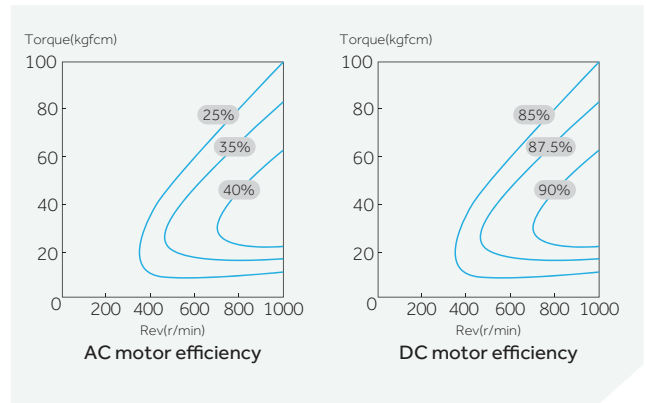

Comfortable

Consistent Air Flow

Up to 3 fans maintain desired air volume as static pressure changes.

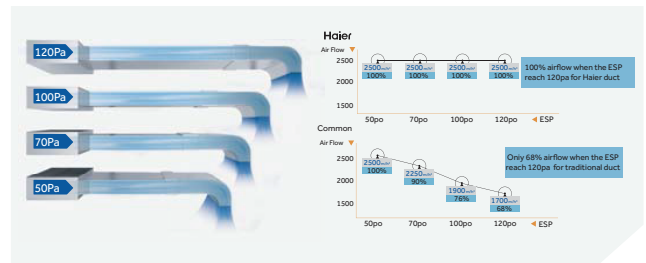

Slim Design

10" cabinet height means easier installation in a wide variety

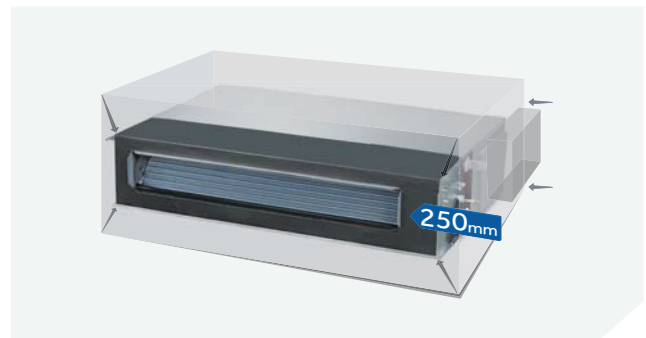

Return Air Options

Installer-friendly design; choose rear or bottom return configuration.



2. Specifications

Model Name	System	AM24LP
	Outdoor	1U24LP2VHA
	Indoor	AM24LP2VH*
Cooling	Rated Capacity Btu/hr	24000
	Capacity Range Btu/hr	6800-30700
	Rated Power Input W	2,182
	SEER	17
	EER	11
	Moisture Removal Pt./h	5.1
Heating	Rate Heating Capacity 47°F Btu/hr	26500
	Heating Capacity Range Btu/hr	6800-34100
	Rated Power Input W	2,089
	HSPF	11
Operating Range	Cooling °F(°C)	0~115F(-18-46C)*
	Heating °F(°C)	-4°F~-75°F (-20-24°C)
Power Supply	Voltage, Cycle, Phase V/Hz/-	208-230/60/1
Outdoor Unit	Compressor Type	DC Inverter Driven Rotary
	Maximum Fuse Size A	25.0
	Minimum Circuit Amp A	21.0
	Outdoor Fan Speed RPM	750/700/650/600/500/400/300
	Outdoor Noise Level dB	47
	Dimension: Height in (mm)	38 (965)
	Dimension: Width in (mm)	37 3/8(950)
	Dimension: Depth in (mm)	14 5/8(370)
Weight (Ship/Net)- lbs (kg)	202.8/ 176.4 (92/80)	
Indoor Unit	Fan Speed Stages	4 + Auto
	Airflow (Turbo/High/Med/Low/Quiet) CFM	845/670/530/470
	Motor Speed (Turbo/High/Med/Low/Quiet) RPM	950/860/760/700
	Indoor Sound Level dB (Turbo/High/Med/Low/Quiet)	38/35/32/29
	Dimension: Height in (mm)	9 7/8 (250)
	Dimension: Width in (mm)	37 5/8 (957)
	Dimension: Depth in (mm)	25 3/4 (655)
	Max. External Static Pressure in.W.G(Pa)	0.6(150)
	Drainpipe Size O.D. in	1 1/4
	Internal Condensate Pump	Standard
	Max. Drain-Lift height in(mm)	27 9/16(700)
	Grill Model	NA
	Grill Dimension: Height in (mm)	NA
	Grill Dimension: Width in (mm)	NA
	Grill Dimension: Depth in (mm)	NA
Weight (Ship/Net)- lbs (kg)	"81.1/68.8 (36.8/31.2)"	
Refrigerant Lines	Connections	Flare
	Liquid O.D. in	3/8
	Suction O.D. in	5/8
	Factory Charge Oz	88.2
	Maximum Line Length Ft / m	165/50
	Maximum Height Ft / m	100/30

Model Name	System	AM36LP
	Outdoor	1U36LP2VHA
	Indoor	AM36LP2VH*
Cooling	Rated Capacity Btu/hr	35000
	Capacity Range Btu/hr	8500-37500
	Rated Power Input W	3,500
	SEER	17
	EER	10
	Moisture Removal Pt./h	6.8
Heating	Rate Heating Capacity 47°F Btu/hr	37500
	Heating Capacity Range Btu/hr	8500-41000
	Rated Power Input W	3,283
	HSPF	10.5
Operating Range	Cooling °F(°C)	0~115F(-18-46C)*
	Heating °F(°C)	-4°F~75°F (-20-24°C)
Power Supply	Voltage, Cycle, Phase V/Hz/-	208-230/60/1
Outdoor Unit	Compressor Type	DC Inverter Driven Rotary
	Maximum Fuse Size A	30
	Minimum Circuit Amp A	26.0
	Outdoor Fan Speed RPM	750/700/650/600/500/400/300
	Outdoor Noise Level dB	52
	Dimension: Height in (mm)	38 (965)
	Dimension: Width in (mm)	37 3/8(950)
	Dimension: Depth in (mm)	14 5/8(370)
Indoor Unit	Weight (Ship/Net)- lbs (kg)	207.2/180.7 (94/82)
	Fan Speed Stages	4 + Auto
	Airflow (Turbo/High/Med/Low/Quiet) CFM	1100/950/735/675
	Motor Speed (Turbo/High/Med/Low/Quiet) RPM	1000/920/860/810
	Indoor Sound Level dB (Turbo/High/Med/Low/Quiet)	32/28/25/23
	Dimension: Height in (mm)	9 7/8 (250)
	Dimension: Width in (mm)	59 (1500)
	Dimension: Depth in (mm)	28 3/8 (720)
	Max. External Static Pressure in.W.G(Pa)	0.6(150)
	Drainpipe Size O.D. in	1 1/4
	Internal Condensate Pump	Standard
	Max. Drain-Lift height in(mm)	27 9/16(700)
	Grill Model	NA
	Grill Dimension: Height in (mm)	NA
	Grill Dimension: Width in (mm)	NA
	Grill Dimension: Depth in (mm)	NA
Weight (Ship/Net)- lbs (kg)	130.1/121.3 (59/55)	
Refrigerant Lines	Connections	Flare
	Liquid O.D. in	3/8
	Suction O.D. in	5/8
	Factory Charge Oz	88.2
	Maximum Line Length Ft / m	165/50
	Maximum Height Ft / m	100/30

Model Name	System	AM48LP
	Outdoor	1U48LP2VHA
	Indoor	AM48LP2VH*
Cooling	Rated Capacity Btu/hr	47000
	Capacity Range Btu/hr	11900-54500
	Rated Power Input W	4,476
	SEER	17
	EER	10.5
	Moisture Removal Pt./h	11.0
Heating	Rate Heating Capacity 47°F Btu/hr	52000
	Heating Capacity Range Btu/hr	13600-64800
	Rated Power Input W	4,407
	HSPF	10
Operating Range	Cooling °F(°C)	0~115F(-18-46C)*
	Heating °F(°C)	-4°F~75°F (-20-24°C)
Power Supply	Voltage, Cycle, Phase V/Hz/-	208-230/60/1
Outdoor Unit	Compressor Type	DC Inverter Driven Rotary
	Maximum Fuse Size A	40
	Minimum Circuit Amp A	35.0
	Outdoor Fan Speed RPM	750/700/650/600/500/400/300
	Outdoor Noise Level dB	53
	Dimension: Height in (mm)	53 1/8 (1350)
	Dimension: Width in (mm)	37 3/8(950)
	Dimension: Depth in (mm)	14 5/8(370)
Weight (Ship/Net)- lbs (kg)	260.1/231.5 (118/105)	
Indoor Unit	Fan Speed Stages	4 + Auto
	Airflow (Turbo/High/Med/Low/Quiet) CFM	1350/1150/930/765
	Motor Speed (Turbo/High/Med/Low/Quiet) RPM	1180/1080/1010/960
	Indoor Sound Level dB (Turbo/High/Med/Low/Quiet)	41/36/33/31
	Dimension: Height in (mm)	9 7/8 (250)
	Dimension: Width in (mm)	59 (1500)
	Dimension: Depth in (mm)	28 3/8 (720)
	Max. External Static Pressure in.W.G(Pa)	0.6(150)
	Drainpipe Size O.D. in	1 1/4
	Internal Condensate Pump	Standard
	Max. Drain-Lift height in(mm)	27 9/16(700)
	Grill Model	NA
	Grill Dimension: Height in (mm)	NA
	Grill Dimension: Width in (mm)	NA
	Grill Dimension: Depth in (mm)	NA
Weight (Ship/Net)- lbs (kg)	132.3/114.6 (60/52)	
Refrigerant Lines	Connections	Flare
	Liquid O.D. in	3/8
	Suction O.D. in	5/8
	Factory Charge Oz	131
	Maximum Line Length Ft / m	230/75
	Maximum Height Ft / m	100/30

3. Dimensions

3.1 AM24LP2VHA

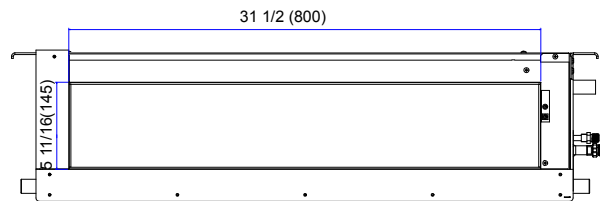

air inlet

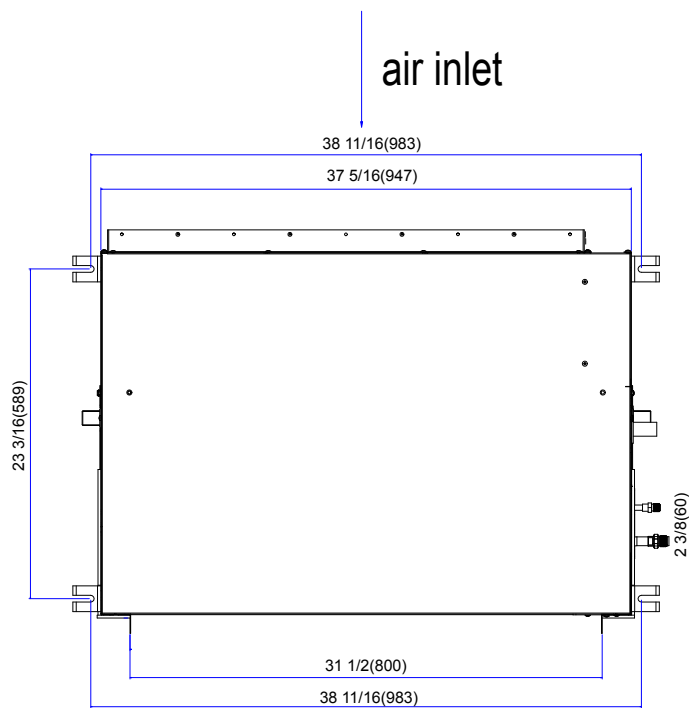
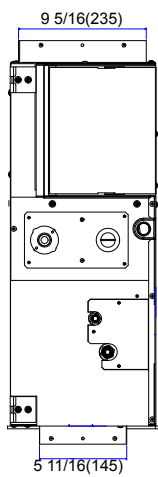

air outlet

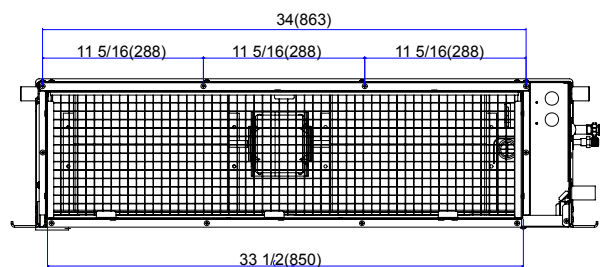
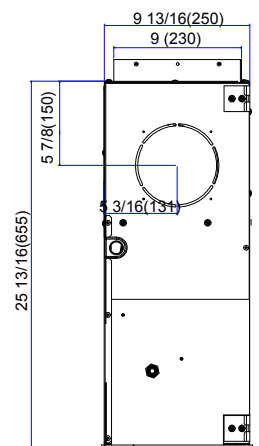

3.2 AM36LP2VHA AM48LP2VHA

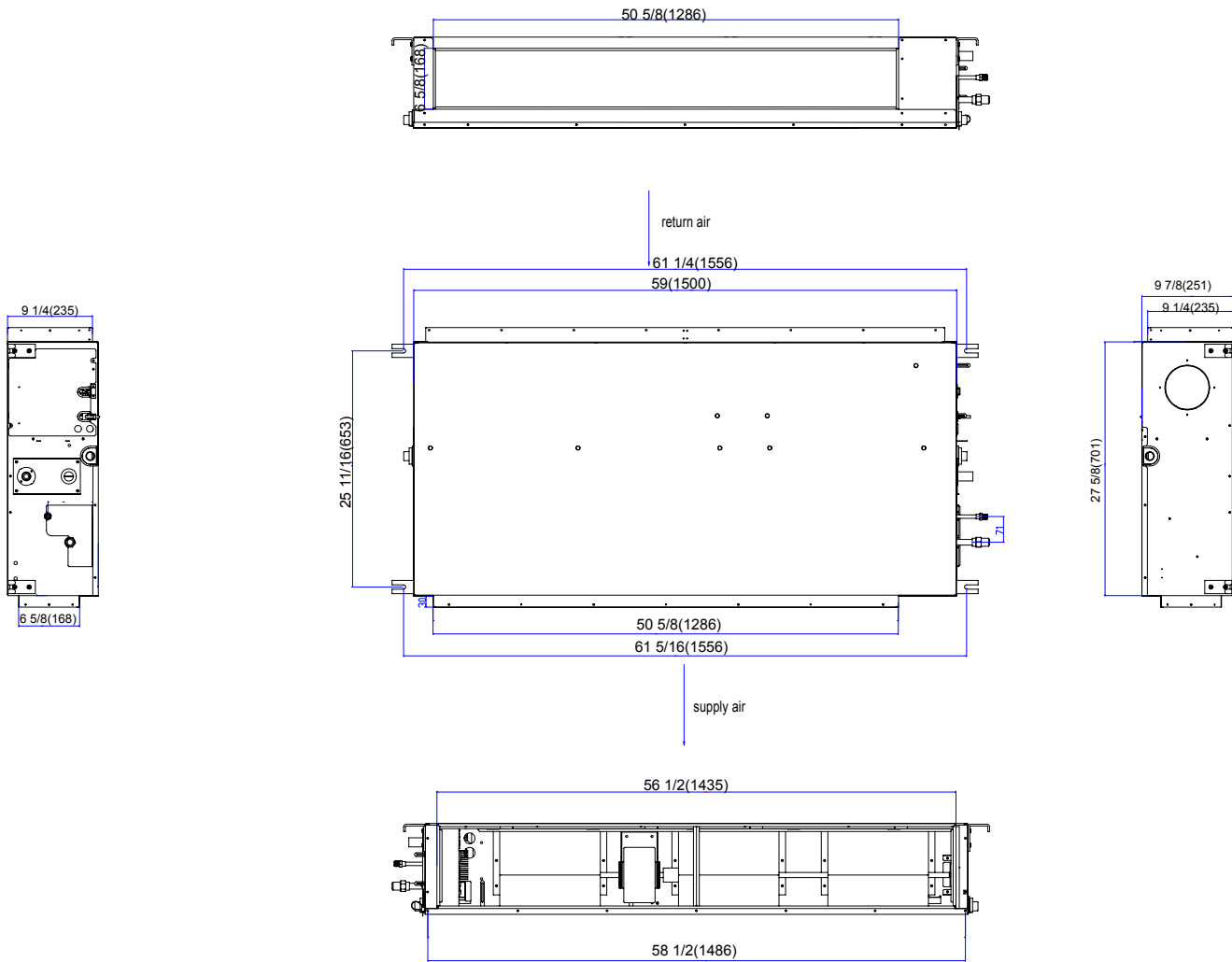

4. Wiring diagrams

AM24LP2VHA

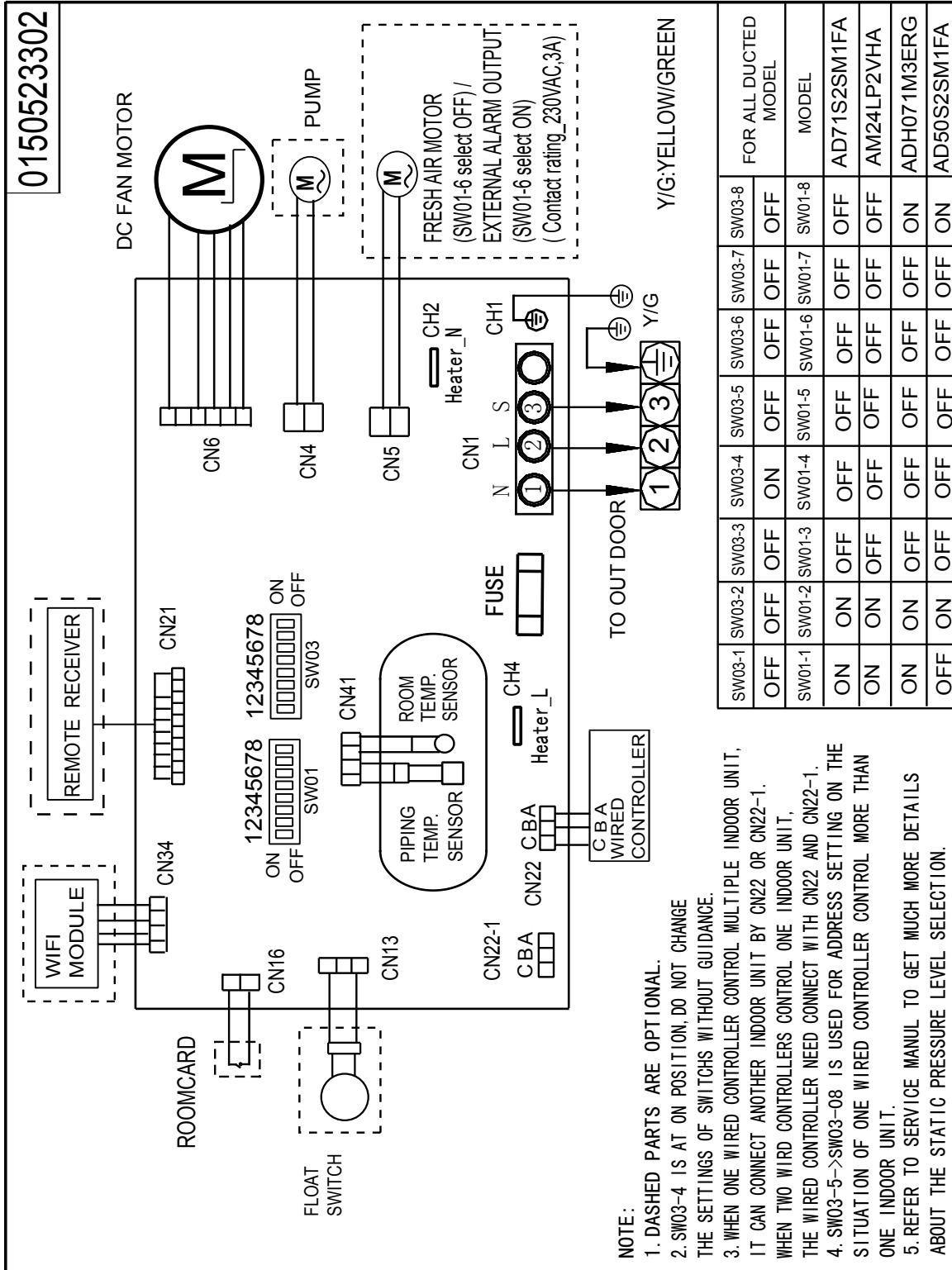

NOTE:

1. DASHED PARTS ARE OPTIONAL.
2. SW03-4 IS AT ON POSITION, DO NOT CHANGE THE SETTINGS OF SWITCHS WITHOUT GUIDANCE.
3. WHEN ONE WIRED CONTROLLER CONTROL MULTIPLE INDOOR UNIT, IT CAN CONNECT ANOTHER INDOOR UNIT BY CN22 OR CN22-1. WHEN TWO WIRD CONTROLLERS CONTROL ONE INDOOR UNIT, THE WIRED CONTROLLER NEED CONNECT WITH CN22 AND CN22-1.
4. SW03-5->SW03-08 IS USED FOR ADDRESS SETTING ON THE SITUATION OF ONE WIRED CONTROLLER CONTROL MORE THAN ONE INDOOR UNIT.
5. REFER TO SERVICE MANUAL TO GET MUCH MORE DETAILS ABOUT THE STATIC PRESSURE LEVEL SELECTION.

AM36LP2VHA AM48LP2VHA

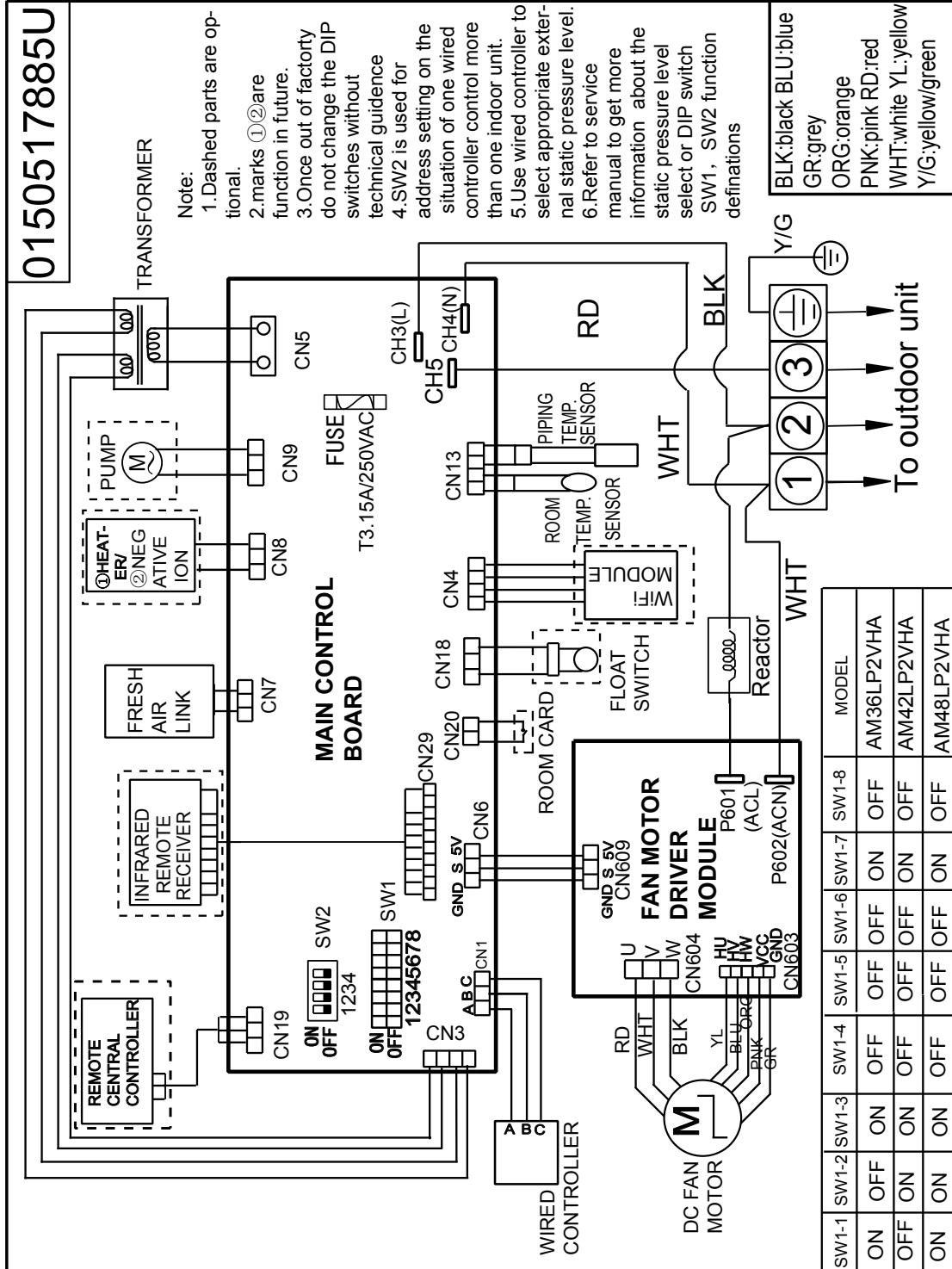

5. Installation

Introduction - Overview

High ESP Duct Product Information

The High ESP Duct Indoor Air Handler ships consisting of a single assembly. The High ESP Duct indoor unit is operated via a factory supplied wired remote control.

The High ESP Duct unit will install above the ceiling or in a soffit area. It is mounted using threaded rods that fit into brackets that are located at all four corners of the High ESP Duct assembly.

The High ESP Duct unit receives 230 volt line voltage from a connection at the outdoor condensing unit. There is no requirement for independent line voltage connections.

The High ESP Duct unit has a built-in condensate pump and associated float switch that manages the operation of the condensate pump. A flexible hose is included with the High ESP Duct unit. This hose connects the High ESP Duct condensate drain outlet to the building's condensate drain system.

Included with the High ESP Duct unit is factory provided insulating tape. This tape should be placed over the refrigerant piping connections at the indoor unit to prevent sweating.

YR-E17 Wired Controller
See Section E for more information



Built-in
Condensate
Pump and
Float Switch



Slim Duct Indoor Unit Specifications

Indoor	AM24LP2VHA	AM36LP2VHA	AM48LP2VHA
Rated Cooling Capacity Btu/hr	24,000	35,000	47,000
Rated Heating Capacity Btu/hr	26,500	37,500	52,000
Voltage, Cycle, Phase V/Hz/-	208/230/60/1	208/230/60/1	208/230/60/1
Fan Speed Stages	4+Auto	4+Auto	4+Auto
Airflow (Turbo/ High/ Med/Low/Quiet) CFM	845/670/530/470	1100/950/735/675	1350/1150/930/765
Motor Speed (Turbo/ High/ Med/Low/Quiet) RPM	950/860/760/700	1000/920/860/810	1180/1080/1010/960
Max. External Static Pressure in.W.G (Pa)	0.6(150)	0.6(150)	0.6(150)
Indoor Sound Level dB (Turbo/High/ Med/Low)	38/35/32/29	32/28/25/23	41/36/33/31
Dimension: Height in (mm)	9 7/8 (250)	9 7/8 (250)	9 7/8 (250)
Dimension: Width in (mm)	37 5/8 (957)	59 (1500)	59 (1500)
Dimension: Depth in (mm)	25 3/4 (655)	28 3/8 (720)	28 3/8 (720)
Weight (Ship/Net)- lbs (kg)	81.1/68.8(36.8/31.2)	130.1/121.3 (59/55)	132.3/114.6 (60/52)
Connections	Flare	Flare	Flare
Liquid O.D. in	3/8	3/8	3/8
Suction O.D. in	5/8	5/8	5/8
Drainpipe Size O.D. in	1 1/4	1 1/4	1 1/4
Internal Condensate Pump	Standard	Standard	Standard
Max. Drain-Lift height in(mm)	27 9/16(700)	27 9/16(700)	27 9/16 (700)

Introduction - Overview

Condensate Handling

The High ESP Duct unit has a built-in condensate pump and water level safety switch. There are also two optional ports for gravity drainage. The condensate pump is rated to lift water up to 27' 9/16" from the point of discharge.

The High ESP Duct unit comes with a grey connection hose with clamp. This hose is connected to the High ESP Duct unit condensate discharge hose port. The other end of the hose is sized to accept 3/4" inch PVC piping.

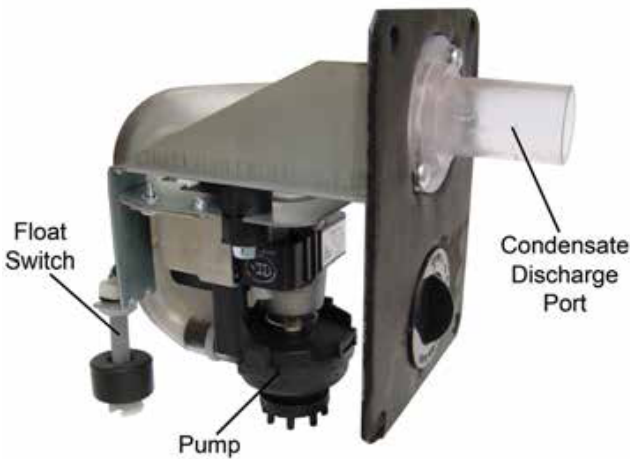

Recommended condensate piping configurations are shown here:

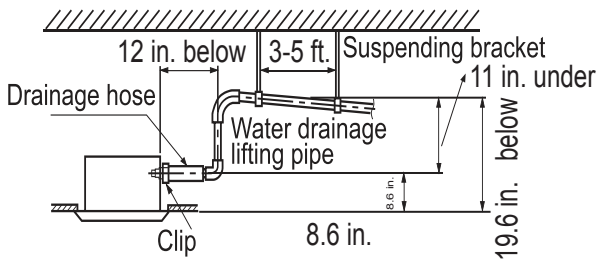

Electrical Power

Follow all local codes and regulations when installing electrical wiring.

Route required electrical power to area where the High ESP Duct unit is to be located. Maintain at least a 10 foot separation between TV and radio wiring and the power to the indoor unit.

14/4 AWG stranded wire should be used to make the electrical connection between indoor and outdoor units. This wiring will serve to power the indoor unit and establish a communication link between indoor and outdoor units.

The wiring is connected at the indoor unit electrical terminal blocks screws 1, 2, 3 and ground. There should be no splices in the wires connected to terminals 1 or 3 as these serve as communication signal wires and electrical power connections. If a safety switch needs to be in place to shut off power to the indoor unit, break wire 2 only.

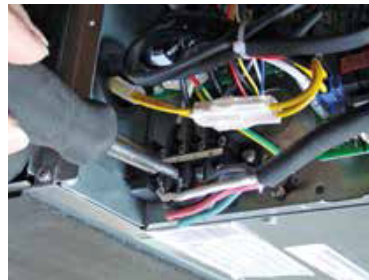

Air Delivery Clearances

Make certain to maintain proper clearances around the unit.

Inadequate clearances can cause system freezing and temperature control problems.

Service and Maintenance Clearances

Make sure there are adequate clearances for future maintenance and service. Allow enough room to access the condensate pump assembly and the electrical control box.

Step 1 - Preparation

Required Tools for Installation

- Drill
- Wire Snipper
- Hole Saw 2 3/4"
- Vacuum pump
- Soap-and-water solution or gas leakage detector
- Torque wrench
- 17mm, 22mm, 26mm
- Tubing cutter
- Flaring tool
- Razor knife
- Measuring tape
- Level
- Micron gauge
- Nitrogen
- Mini-Split AD-87 Adapter (1/4" to 5/16")
- A - Non-adhesive Tape
- B - Adhesive Tape
- C - Saddle (L.S.) with screws
- D - Electrical wiring
- E - Drain hose (Included)
- F - Insulation
- G - Piping hole cover (Included)

Procedure for Selecting the Location

- Place above the ceiling or in soffit area where you have enough space to position the unit.
- Place where the drainage pipe can be properly positioned.
- Place where the inlet and outlet air of the indoor unit will not be blocked.
- Do not install the unit in a place with heavy oil or moisture (e.g. - kitchens and workshops)
- Do not install in a location with destructive gas (such as sulfuric acid gas) or pungent gas (thinner and gasoline) are used or stored.
- Choose a place solid enough to bear the weight and vibration of the unit and where the operation noise will not be amplified.
- Install where there are no expensive items like a television or piano below the indoor unit.
- Leave enough space for maintenance.
- Install at least 3 ft. away from televisions and radios to avoid interference.

Note:

- 1) R-410A refrigerant is a safe, nontoxic and nonflammable refrigerant. However, if there is a concern about a dangerous level of refrigerant concentration in the case of refrigerant leakage, add extra ventilation.

Threaded Rod Mounting Information

The High ESP Duct unit should be mounted to the building structure using threaded rods. The threaded rods should have washers and nuts to allow the height and level of the High ESP Duct unit to be adjusted.

The threaded rods and attachment brackets are field supplied items. The materials required for mounting to the brackets include:

- 4- 3/8" Threaded Rods
- 4- Mounting Brackets
- Washers
- Nuts (Double nut the assembly as shown in step 2.3)

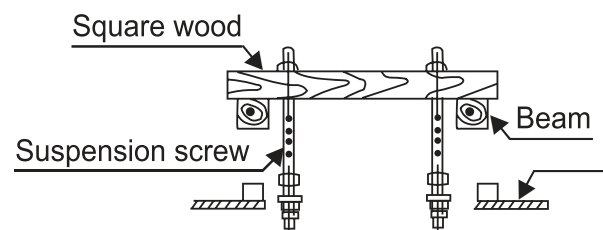
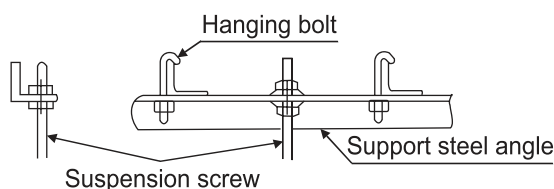

Step 2 - Installation of the High ESP Duct Unit

Step-by-step Installation Guide

2.1 Step 2.1

Determine and mark the position of where the High ESP Duct unit is to be installed. Install the hardware necessary to mount the threaded rods. Always select a location strong enough to support the indoor High ESP Duct unit.

2.2 Step 2.2

Install the threaded rods to the hardware attached to the structure.

2.3 Step 2.3

Lift the High ESP Duct unit and position the threaded rods into the 4 mounting clips, one located on each corner of the unit.

2.4 Step 2.4

Using a level, adjust the nuts on the threaded rods to obtain level readings both side to side and front to back

2.5 Step 2.5 - 2.5A

Prior to routing the refrigerant lines to the unit, install the supplied flare nuts onto the refrigerant lines. Using a flaring tool, flare the refrigerant lines. Remove the caps attached to the ends of the refrigerant line connections. Holding charge should leak out. Attach the refrigerant lines to the air handler.

Using a torque wrench, torque the fittings to the proper specification. (See Outdoor Unit Section for flare torque settings.)

2.6 Step 2.6

Connect the grey flexible drain hose supplied with the High ESP Duct unit to the condensate pump discharge pipe of the High ESP Duct unit. Tighten the clamp securely. Using 3/4" PVC, connect the flexible hose to the building's condensate drains system.

2.7 Steps 2.7 - 2.7A - 2.7B

Route the 14AWG stranded 4 conductor power/communication cable and the wired remote cable to the air handler. Use reducing washers and appropriate connector to attach the power/communication cable to the unit. The wired remote cable will enter the unit through a rubber grommet. The 4 conductor cable connects to the terminal block at terminals 1, 2, 3, and ground. The wired remote cable connects to the air handler main board at connector CN1. Re-install electrical box cover.

2.8 Step 2.8

The unit is now ready for connection to the ductwork. The return air duct can be installed in either a rear or bottom configuration.

Step 2.1



Step 2.2



Step 2.3



Step 2.4

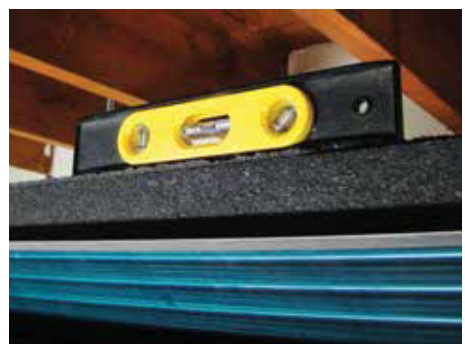

Step 2 - Installation of the High ESP DuctUnit

Step 2.5



Step 2.7A

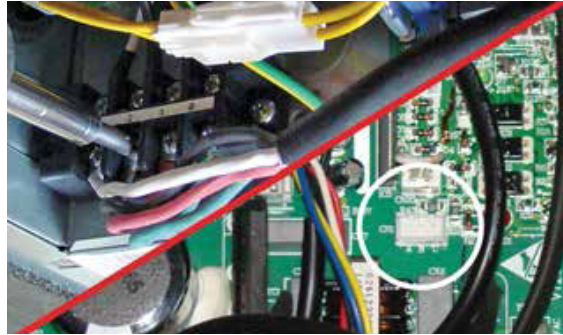

Step 2.5A



Step 2.7B
Re-install electrical box cover



Step 2.6

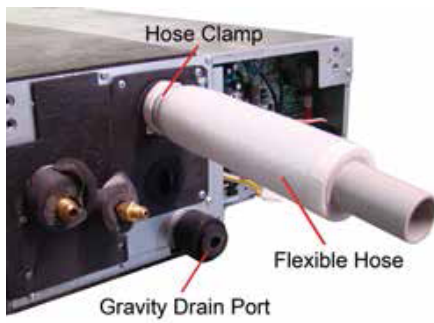

Step 2.8

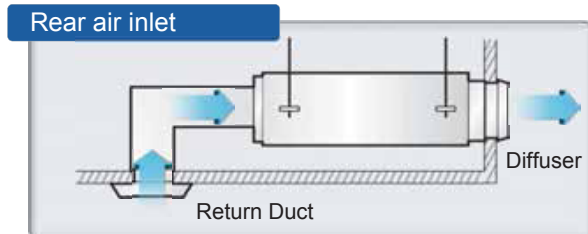

Step 2.7

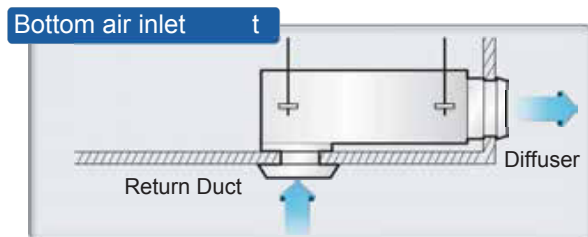

Step 3 - Electrical Connections

Electrical Connections Indoor and Outdoor Units

14/4 AWG stranded wire only. (Central Controller Not Used)
 Maintain 10 feet of separation between TV and any radio wiring.

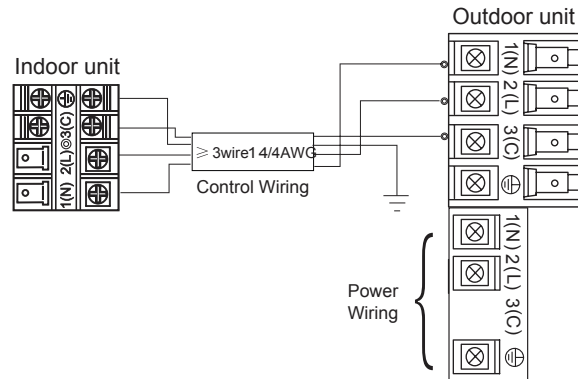

Note: High ESP Duct unit ships with YR-E17 wired controller. See Section E for more information.

Step 4 - Evacuate System

See Step 3.2 of the outdoor unit installation section for how to pull a vacuum.

Part 5 Outdoor Units

1. Specifications50

2. Dimensions.....53

3. Piping55

4. Wiring diagrams55

5. Installation58

1. Specifications

Item		Model	1U24LP2VHA			
Power cable			H05RN-F 3G 4.0mm ²			
Communication cable/Connecting cable			H05RN-F 4G 2.5mm ²			
Power source		N, V, Hz	1PH, 220-240V~, 50/60Hz			
Start current		A	3			
Outdoor unit	Unit model (color)		1U24LP2VHA (WHITE)			
	Compressor	Model/Manufacture/ place		TNB220FFEMC		
		Oil model		FV50S		
		Oil charging		CC	520	
		Type		Rotary		
	Fan	Type×Number		Axial×1		
		Speed		r/min	650/600/500/400/300/200	
		Fan motor output/input power		kW	100/120	
		Air-flow (H-M-L)		m ³ /h	3200	
	Coil	Type/Diameter		mm	TP2M/Φ7 wide fin	
		Row/Fin pitch			2	1.65
		Total area		m ²	/	
	Dimensions	External	(L×M×H)	mm×mm×mm	965*950*370	
		Package	(L×M×H)	mm×mm×mm	1095*1050*450	
	Drainage pipe (material, I.D./O.D.)		mm	None		
	Refrigerant control method		mm/mm	2.2mm electronic expansion valve		
	Defrosting			Auto		
	Volume of accumulator		L	2.1		
	Sound power noise level (H-M-L)		dB (A)	64		
	Sound pressure noise level (H-M-L)		dB (A)	47		
	Type of four way valve			SHF-4-10A		
	Insulation material			Felt		
	Crankcase heater power		W	/		
Weight (Net/Shipping)		kg/kg	80/92			
Piping	Refrigerant	Type/Charge		g	R410A/2500	
		Recharge quantity		g/m	45	
	Pipe	Liquid		mm	9.52	
		Gas		mm	15.88	
	Connecting method			Flared		
	Between I.D & O.D	MAX. Drop		m	30	
MAX. Piping length		m	50			
Maximum pipe length without recharge refrigerant		m	20			
Working temp.	Cooling (Min-Max)		°C	-15~50		
	Heating (Min-Max)		°C	-20~24		
Norminal condition: Indoor temperature (cooling) : 80.6DB (°F)/66WB (°C) , Indoor temperature (heating) : 68DB (°F) Outdoor temperature (cooling) : 95DB (°F)/75WB (°F) , Outdoor temperature (heating) : 44.6DB (°F)/42.8WB (°F) The noise level will be measured in the third octave band limited values, using a Real Time Analyzer calibrated sound intensity meter. It is a sound pressure noise level.						

Item		Model	1U36LP2VHA	
Power cable			H05RN-F 3G 4.0mm ²	
Communication cable/Connecting cable			H05RN-F 4G 2.5mm ²	
Power source		N, V, Hz	1PH, 220-240V~, 50/60Hz	
Start current		A	3	
Outdoor unit	Unit model (color)		1U36LP2VHA (WHITE)	
	Compressor	Model/Manufacture/ place	TNB306FPPMC	
		Oil model	FV50S	
		Oil charging	CC	870
		Type	Rotary	
	Fan	Type×Number	Axial×1	
		Speed	r/min	750/700/650/600/500/400/300
		Fan motor output/input power	kW	100/120
		Air-flow (H-M-L)	m ³ /h	4000
	Coil	Type/Diameter	mm	TP2M/Φ7 wide fin
		Row/Fin pitch		2 1.65
		Total area	m ²	/
	Dimensions	External (L×M×H)	mm×mm×mm	965*950*370
		Package (L×M×H)	mm×mm×mm	1095*1050*450
	Drainage pipe (material, I.D./O.D.)		mm	None
	Refrigerant control method		mm/mm	2.2mm electronic expansion valve
	Defrosting			Auto
	Volume of accumulator		L	2.1
	Sound power noise level (H-M-L)		dB (A)	68
	Sound pressure noise level (H-M-L)		dB (A)	52
Type of four way valve			SHF-4-10A	
Insulation material			Felt	
Crankcase heater power		W	/	
Weight (Net/Shipping)		kg/kg	82/94	
Piping	Refrigerant	Type/Charge	g	R410A/2500
		Recharge quantity	g/m	45
	Pipe	Liquid	mm	9.52
		Gas	mm	15.88
	Connecting method			Flared
	Between I.D & O.D	MAX. Drop	m	30
MAX. Piping length		m	50	
Maximum pipe length without recharge refrigerant		m	20	
Working temp.	Cooling (Min-Max)	°C	-15~50	
	Heating (Min-Max)	°C	-20~24	
Norminal condition: Indoor temperature (cooling) : 80.6DB (°F)/66WB (°C) , Indoor temperature (heating) : 68DB (°F) Outdoor temperature (cooling) : 95DB (°F)/75WB (°F) , Outdoor temperature (heating) : 44.6DB (°F)/42.8WB (°F) The noise level will be measured in the third octave band limited values, using a Real Time Analyzer calibrated sound intensity meter. It is a sound pressure noise level.				

Item		Model	1U48LP2VHA			
Power cable			H05RN-F 5G 2.5mm ²			
Communication cable			/			
Connecting cable			H05RN-F 4G 2.5mm ²			
Power source		N, V, Hz	3N~, 380~415, 50/60Hz			
Start current		A	3			
Outdoor unit	Unit model (color)		1U48LP2VHA			
	Compressor	Model/Manufacture/place		MNB42FFAMC-L (MITSUBISHI ELECTRIC COMPRESSOR CO., LTD)		
		Oil model		PVE (FV50S)		
		Oil charging		CC	1600	
		Type		Twin Rotary 1		
	Fan	Type×Number		Axial×2		
		Speed		r/min	700±40	
		Fan motor input power		kW	0.12×2	
		Fan motor output power		kW	0.10×2	
		Air-flow (H-M-L)		m ³ /h	7000	
	Coil	Type/Diameter		mm	TP2M/Φ7.0	
		Row/Fin pitch			2	1.4
		Total area		m ²	1.17	
	Dimensions	External (W×D×H)		mm×mm×mm	950×370×1350	
		Package (W×D×H)		mm×mm×mm	1090×480×1500	
	Drainage pipe (material, I.D./O.D.)		mm	None		
	Refrigerant control method		mm/mm	ELECTRONIC VAVE 3.0mm		
	Defrosting			Auto		
	Volume of accumulator		L	4.0		
	Sound power Noise level (H-M-L)		dB (A)	70		
Sound pressure Noise level (H-M-L)		dB (A)	53			
Type of four way valve			SHF-20D-46			
Insulation material			XPE			
Crankcase heater power		W	38			
Weight (Net/Shipping)		kg/kg	108/121			
Piping	Refrigerant	Type/Charge		g R410A/3700		
		Maximum pipe length without recharge refrigerant		30		
		Recharge quantity		g/m	45	
	Pipe	Liquid		mm	9.52	
		Gas		mm	15.88	
	Connecting method			Flared		
	Between I.D & O.D	MAX. Drop		m	30	
MAX. Piping length		m	75			
Norminal condition:						
Indoor temperature (cooling) : 80.6DB (°F)/66WB (°C) , Indoor temperature (heating) : 68DB (°F)						
Outdoor temperature (cooling) : 95DB (°F)/75WB (°F) , Outdoor temperature (heating) : 44.6DB (°F)/42.8WB (°F)						
The noise level will be measured in the third octave band limited values, using a Real Time Analyzer calibrated sound intensity meter. It is a sound pressure noise level.						

2. Dimensions

1U24LP2VHA 1U36LP2VHA

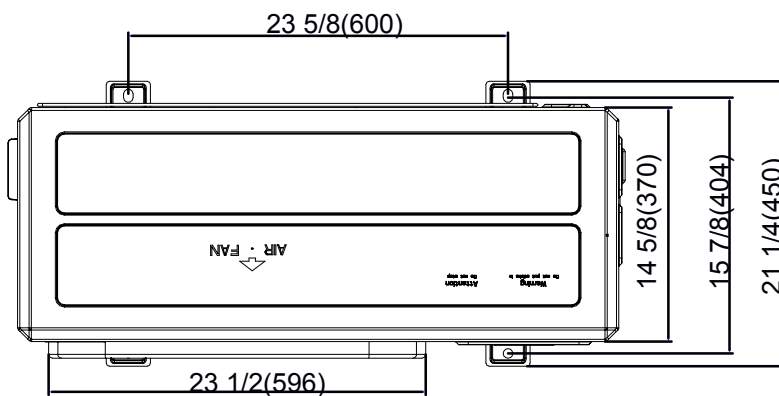
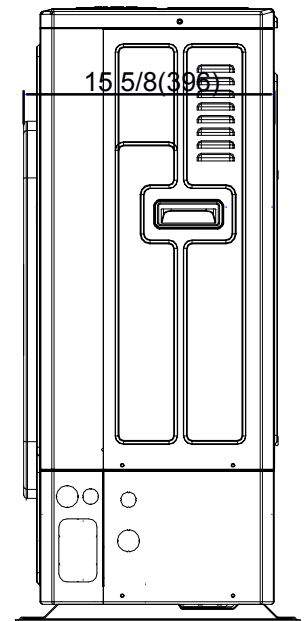
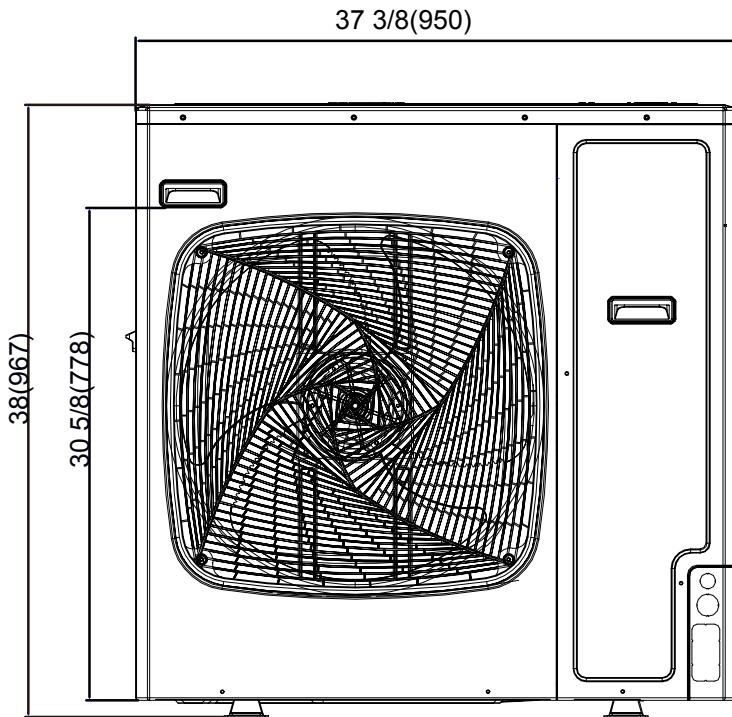

1U48LP2VHA

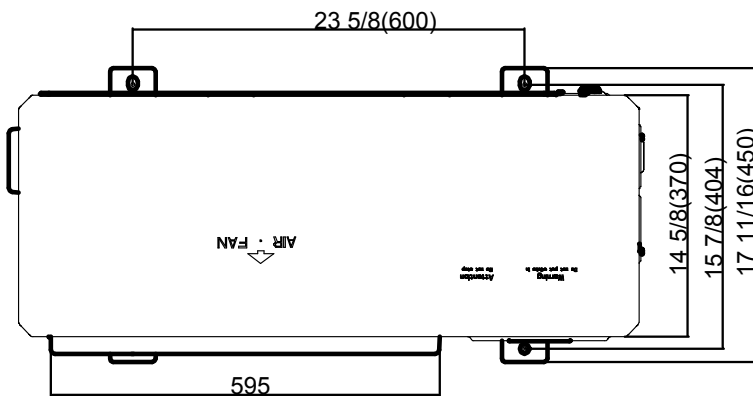
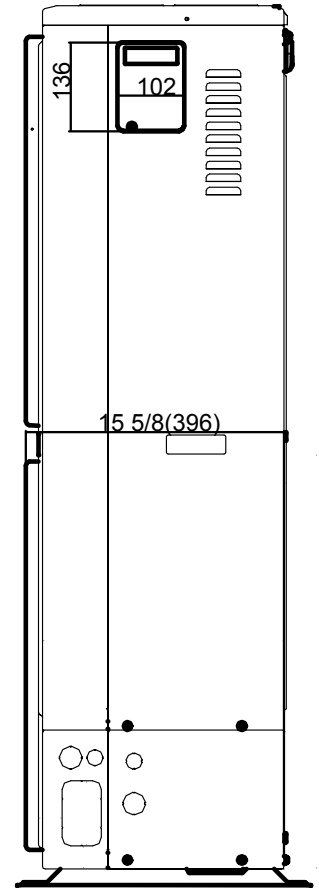
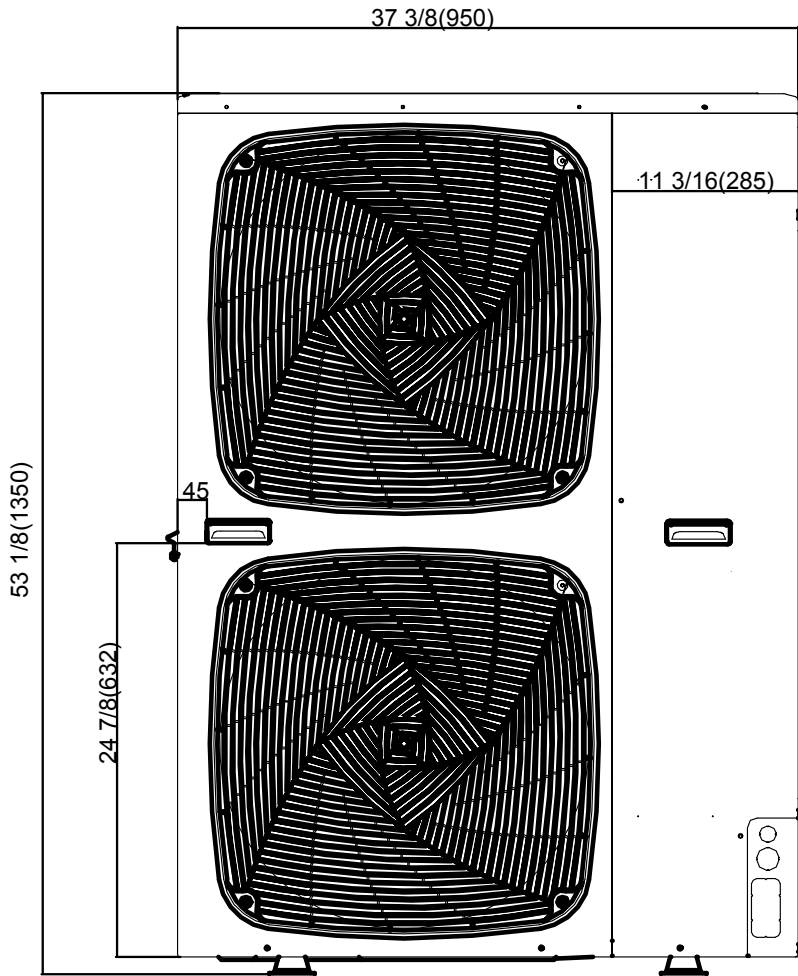

3. Piping

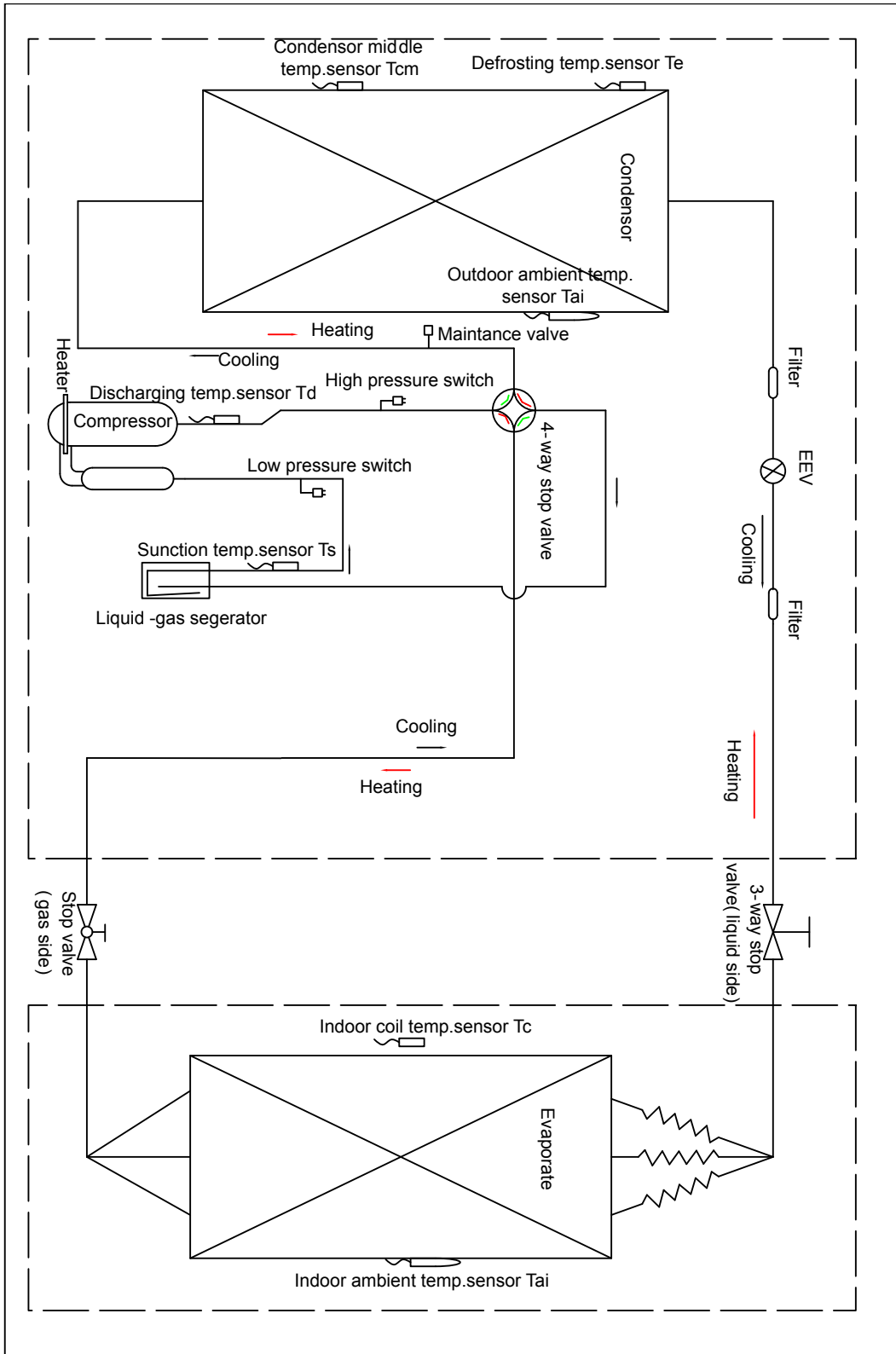

4. Wiring diagrams

1U36LP2VHA 1U36LP2VHA

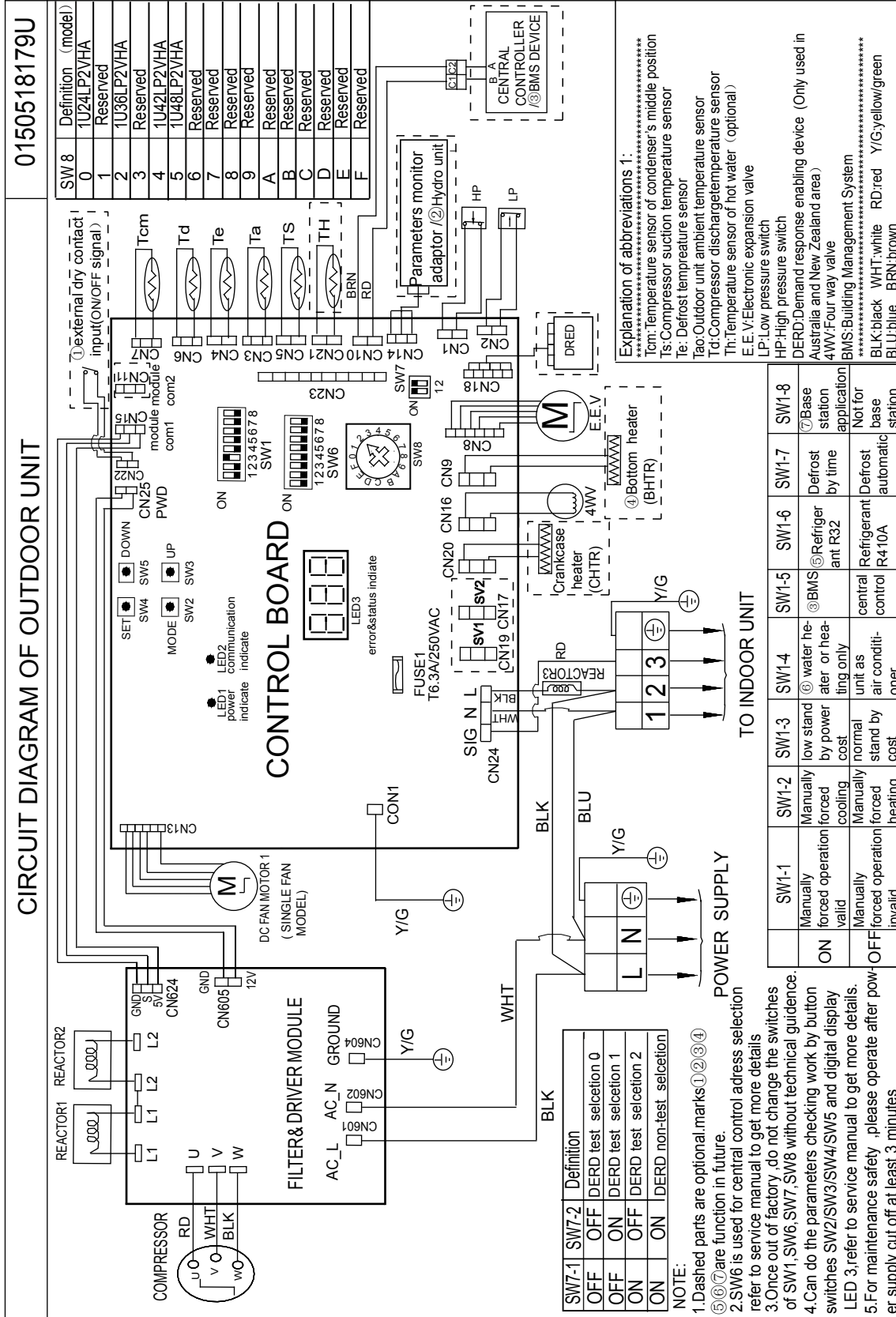

1U48LP2VHA

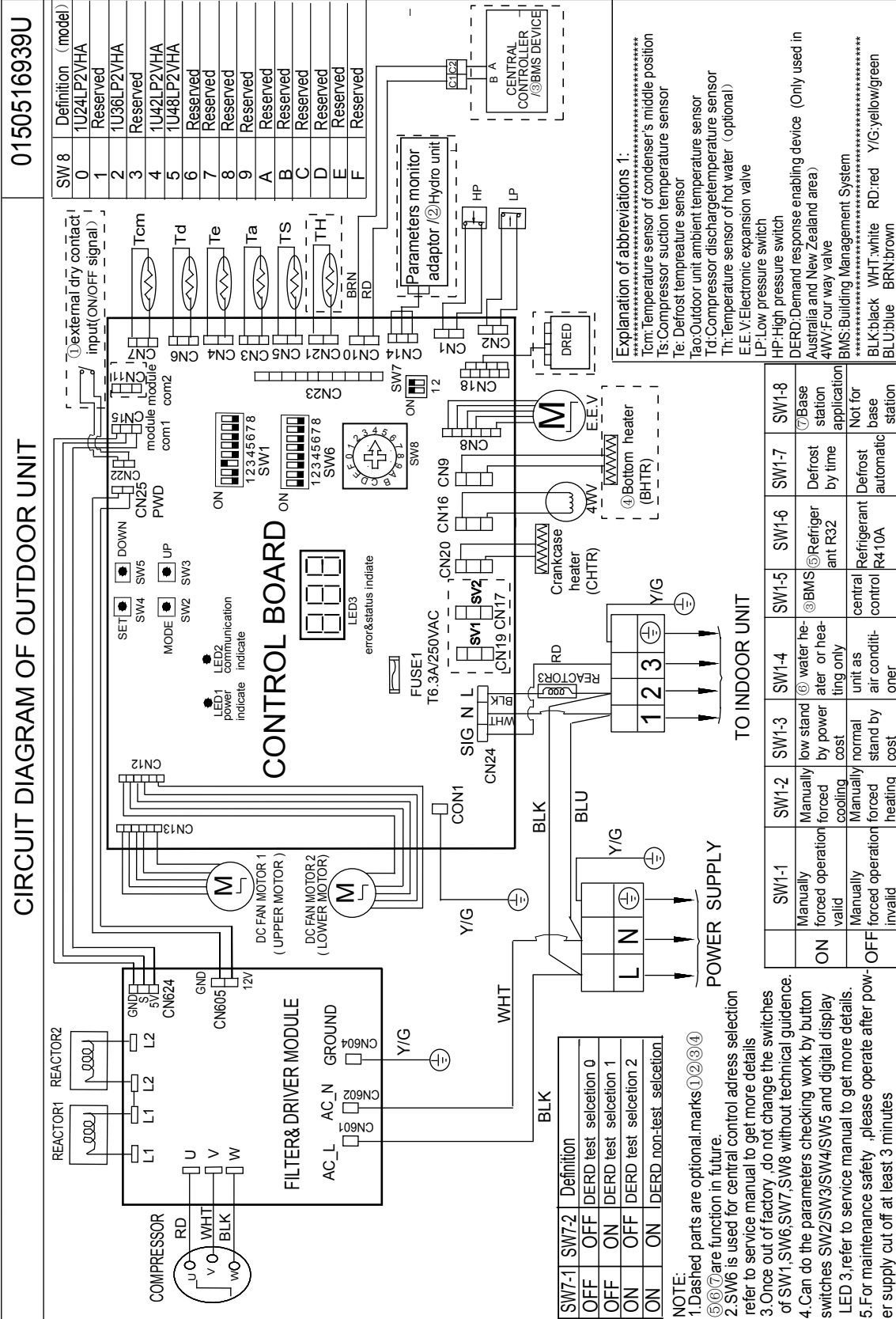

5. Installation

Step 1 - Installation of the Outdoor Unit

Attaching Drain Elbow to Outdoor Unit

1.1 Step - 1.1

If attaching the supplied drain elbow to the outdoor unit, do so prior to attaching the refrigerant lines and wiring. Extension piping to attach to this fitting is field supplied.



Step 1.1



Step 1.2

Electrical Connections for the Outdoor Unit

1.2 Step - 1.2

Remove the cover plate of the outdoor unit to expose the terminal block connections.

1.3 Step - 1.3

Connect the wiring for both the power source and indoor wiring. Wire the system according to applicable national / local codes. Verify that the wiring connections for the indoor unit match wire for wire. (1-1, 2-2, 3-3, Gnd-Gnd). Failure to wire the system correctly may lead to improper operation or component damage.



Step 1.3



Step 1.4

1.4 Step - 1.4

Replace the cover plate.

Step 2 - Connecting the Indoor Unit

*See indoor section A, B, or C for electrical connections.

Piping

The standard lineset length is 25ft. If the installation length is different, adjust the refrigerant charge by 0.5oz/ft. for the 24k,36k,42k and 48k model. (Illustration 4)

Cut the lineset to length, flare and attach the piping to the outdoor unit valves. Torque the fittings to the specifications shown in the torque chart.

2.1 Step - 2.1

Refrigerant piping connections at the indoor unit are made utilizing flare joints. Follow standard practices for creating pipe flares. When cutting and reaming the tubing, use caution to prevent dirt or debris from entering the tubing. Remember to place the nut on the pipe before creating the flare.

2.2 Step - 2.2

To join the lineset piping together, directly align the piping flare to the fitting on the other pipe, then slide the nut onto the fitting and tighten. Misalignment may result in a leaking connection.

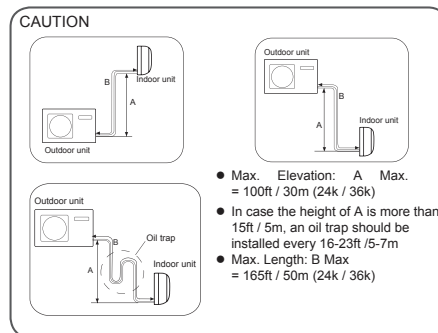

Illustration 4



Step 2.1



Step 2.2

2.3 Step - 2.3

Two wrenches are required to join the flare connections, one standard wrench, and one torque wrench. See Table 1 for the specific torque per piping diameter.

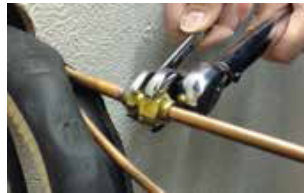

Step 2.3

Half union	Flare nut	Forced fastening without careful centering may damage the threads and cause a leakage of gas.	
Spanner	Torque wrench		
Pipe Diameter(φ)		Fastening torque	
Liquid side 6.35mm(1/4")		18N.m/13.3Ft.lbs	
Liquid/Gas side 9.52mm(3/8")		42 N.m/30.1Ft.lbs	
Gas side 12.7mm(1/2")		55N.m/40.6Ft.lbs	
Gas side 15.88mm(5/8")		60 N.m/44.3Ft.lbs	

Table 1

Step 3 - Leak Test and Evacuation

Leak Test

Hazard of Explosion Never use an open flame to detect refrigerant leaks. Explosive conditions may occur. Use a leak test solution or other approved methods for leak testing. Failure to follow recommended safe leak test procedures could result in death or serious injury or equipment or property damage.

Use only dry nitrogen with a pressure regulator for pressurizing unit. Do not use acetylene, oxygen or compressed air or mixtures containing them for pressure testing. Do not use mixtures of a hydrogen containing refrigerant and air above atmospheric pressure for pressure testing as they may become flammable and could result in an explosion. Refrigerant used as a trace gas should only be mixed with dry nitrogen for pressurizing units. Failure to follow these recommendations could result in death or serious injury or equipment or property damage.



Step 3.1



Step 3.2

3.1 Step - 3.1

Using a tank of nitrogen with attached regulator, charge the system with 150 PSIG of dry nitrogen. Use adapter AD-87 (field supplied) to connect to the service valve. Check for leaks at the flare fittings using soap bubbles or other detection methods. If a leak is detected, repair and recheck. If no leaks are detected, proceed to evacuate the system.

System Evacuation

3.2 Step - 3.2

Attach a manifold gauge, micron gauge, and vacuum pump to the suction line port using adapter AD-87 (field supplied). (Illustration 5)

Evacuate the system to 350 microns. Close the vacuum pump valve and check the micron gauge. If the gauge rises above 500 microns in 60 seconds, evacuation is incomplete or there is a leak in the system. If the gauge does not rise above 500 microns in 60 seconds, evacuation is complete.

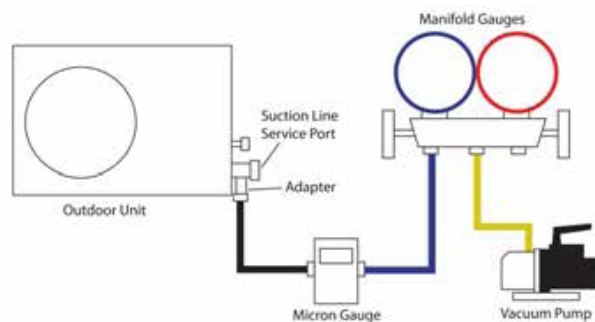

Illustration 5

3.3 Step - 3.3

Remove the adapter and hose connection from the suction line port, and replace the cap. Hoses should not be removed and service valves should not be opened until any additional refrigerant needed for a refrigerant line longer than 25 ft. has first been added

3.4 Step - 3.4A & 3.4B

Remove the cap from the liquid line valve. Using the hex wrench, open the valve, then replace and tighten the cap.

3.5 Step - 3.5A & 3.5B

Remove the cap from the suction line valve. Using the hex wrench, open the valve, then replace and tighten the cap.

3.6 Step - 3.6

Wrap the lineset, drain line, and wiring starting at the bottom of the bundle with an overlap type wrap, concluding at the piping hole. Use a sealant to seal the piping hole opening to prevent weather elements from entering the building. (Illustration 6)

Verify the condensate drain line has a constant pitch downward for proper water flow. There should be no kinks or rises in the tubing which may cause a trapping effect resulting in the failure of the condensate to exit the piping.



Step 3.3



Step 3.4A



Step 3.4B



Step 3.5A



Step 3.5B



Step 3.6

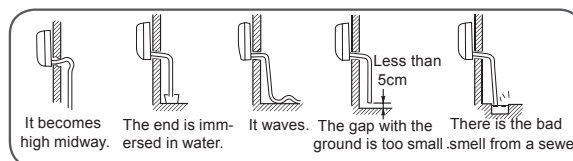

Illustration 6

Step 4 - Charging

See Steps 5.2 - 5.5 for evacuating the system prior to charging. The standard lineset length is 25ft. If the installation length is different, adjust the refrigerant charge by 0.5oz / ft. for the 24K, 36K and 48K model. (Step 4 - Illustration 4)

Refrigerant Charge Label

This product contains fluorinated greenhouse gases covered by the Kyoto Protocol. Do not vent into the atmosphere.

Refrigerant type: R410A

GWP* value: 1975

GWP = global warming potential

Please fill in with indelible ink,

- 1 the factory refrigerant charge of the product
- 2 the additional refrigerant amount charged in the field and
- 1+2 the total refrigerant charge on the refrigerant charge label supplied with the product.

The filled out label must be adhered in the proximity of the product charging port (e.g. onto the inside of the stop valve cover).

A - contains fluorinated greenhouse gases covered by the Kyoto Protocol

B - factory refrigerant charge of the product: see unit name plate

C - additional refrigerant amount charged in the field

D - total refrigerant charge

E - outdoor unit

F - refrigerant cylinder and manifold for charging

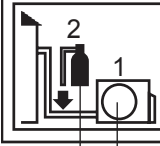
Contains fluorinated greenhouse gases covered by the Kyoto Protocol		A
R410A	1= <input type="text"/> OZ	B
	2= <input type="text"/> OZ	C
	1+2= <input type="text"/> OZ	D
		F E

System Test

Using the instruction manual, show the customer how to properly use and care for the equipment.

Check List

Put check mark in boxes

- No refrigerant leaks from line sets or other connections?
- Are the linesets insulated properly?
- Are the connecting wirings of indoor and outdoor firmly inserted to the terminal block?
- Is the connecting wiring of indoor and outdoor firmly connected?
- Is condensate draining correctly?
- Is the indoor unit securely attached?
- Is power source voltage correct according to local code?
- Is there any noise?
- Is the lamp normally lighting?
- Are cooling and heating (when in heat pump) performing normally?
- Is the operation of room temperature sensor normal?

Section 5 - Explaining Operation to the End User

- Using the OPERATING INSTRUCTIONS, explain to the user how to use the air conditioner (the remote controller, removing the air filters, placing or removing the remote controller from the remote controller holder, cleaning methods, precautions for operation, etc.)
- Recommend that the user read the OPERATING INSTRUCTIONS carefully.

Section 6 - Seacoast Application

- The outdoor unit should be installed at least ½ mile away from the salt water, including seacoasts and inland waterways. If the unit is installed from 1/2 to 5 miles from salt water, follow the instructions below.
- Install the outdoor unit in a place (such as near buildings etc.) where it can be protected from sea breeze which can damage the outdoor unit.

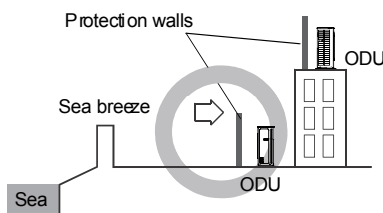
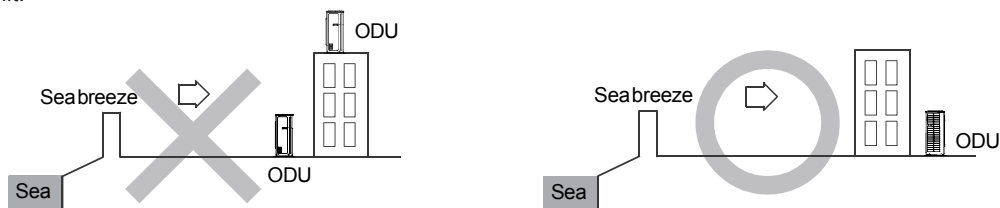

- If the above locations are not available, a solid protection wall should be constructed to protect the outdoor unit from sea breezes. The wall should be 1.5 times the height and width of the unit and allow 24" clearance for air flow. Lacking a location that will satisfy the above conditions, contact Haier directly.

- Install the outdoor unit in a place where water can drain smoothly.
- If you cannot find a place satisfying above conditions, please contact manufacturer. Make sure to clean the sea water and the dust on the outdoor coil.

Part 6 Controls and Troubleshooting

1. Indoor PCB	64
2. Indoor Dip Switches	65
3. Outdoor PCB	68
4. Error codes	70
5. Troubleshooting Error Codes	83
6. Functions	92
7. Controllers	104

1. Indoor PCB

1.1 AL24LP2VHA AL36LP2VHA AL48LP2VHA
PCB 0151800208

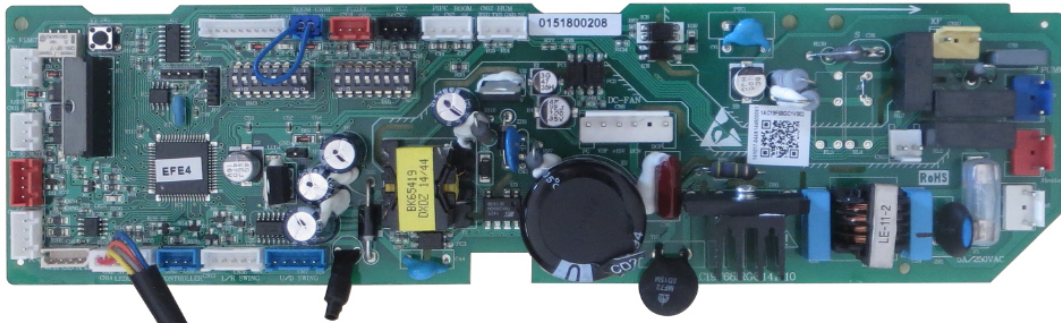

1.2 AM24LP2VHA
PCB 0151800267

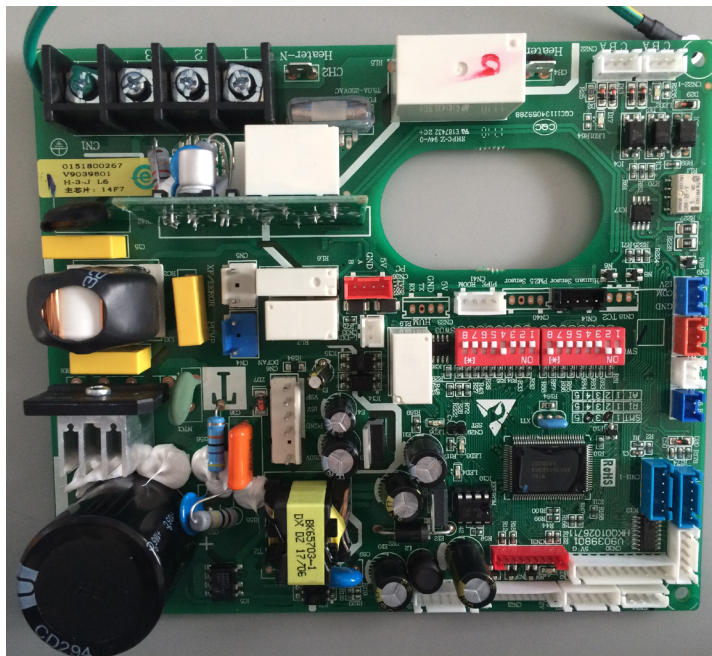

1.3 AM36LP2VHA AM48LP2VHA
PCB 0151800106E

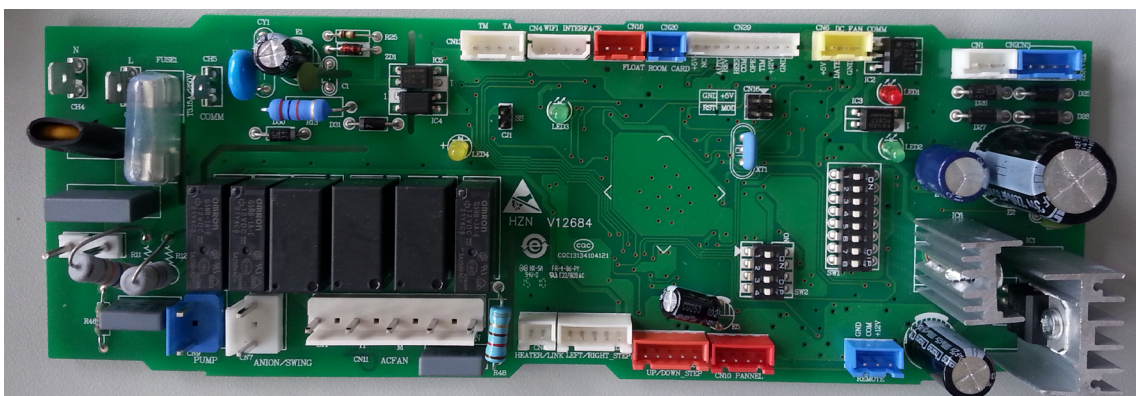

2. Indoor Dip Switches

Settings as shipped

AL24LP2VHA AL36LP2VHA AL48LP2VHA :

PCB 0151800208

BM1 (1-ON, 0-OFF)								
Capacity (SW1-1→SW1-3)			Room card SW1-4	Running mode SW1-5	Unit Type			Description
SW1-1	SW1-2	SW1-3			SW1-6	SW1-7	SW1-8	
1	1	0	---	---	---	---	---	Capacity: 24kBTU(7.1kW)
0	0	1	---	---	---	---	---	Capacity: 30kBTU(9.0kW)
1	0	1	---	---	---	---	---	Capacity: 35kBTU(10.5kW)
0	1	1	---	---	---	---	---	Capacity: 42kBTU(12.5kW)
1	1	1	---	---	---	---	---	Capacity: 48kBTU(14.0kW_
---	---	---	0	---	---	---	---	Room card invalid(default)
---	---	---	1	---	---	---	---	Room card valid
---	---	---	---	0	---	---	---	Heat pump(default)
---	---	---	---	1	---	---	---	Cooling only
---	---	---	---	---	0	0	1	High performance cassette

Wired controller communication address

BM3-5	BM3-6	BM3-7	BM3-8	Indoor unit Address (Indoor unit address for one wired controller control more than one unit)
OFF	OFF	OFF	OFF	0 (master)
OFF	OFF	OFF	ON	1(slave)
OFF	OFF	ON	OFF	2(slave)
OFF	OFF	ON	ON	3(slave)
OFF	ON	OFF	OFF	4(slave)
OFF	ON	OFF	ON	5(slave)
OFF	ON	ON	OFF	6(slave)
OFF	ON	ON	ON	7(slave)
ON	OFF	OFF	OFF	8(slave)
ON	OFF	OFF	ON	9(slave)
ON	OFF	ON	OFF	10(slave)
ON	OFF	ON	ON	11(slave)
ON	ON	OFF	OFF	12(slave)
ON	ON	OFF	ON	13(slave)
ON	ON	ON	OFF	14(slave)
ON	ON	ON	ON	15(slave)

AM24LP2VHA

PCB 0151800267

SW1-1	SW1-2	SW1-3	SW1-4	SW1-5	SW1-6	SW1-7	SW1-8	Description
1	1	0	---	---	---	---	---	AM24LP2VHA
---	---	---	0	---	---	---	---	Room card invalid(default)
---	---	---	1	---	---	---	---	Room card valid
---	---	---	---	0	---	---	---	Cool and heat(default)
---	---	---	---	1	---	---	---	Cool only
---	---	---	---	---	0	---	---	External alarm output(default)
---	---	---	---	---	1	---	---	Fresh air
---	---	---	---	---	---	0	---	Without filter clean remind (default)
---	---	---	---	---	---	1	---	With filter clean remind
---	---	---	---	---	---	---	0	ESP DUCT (USA)
---	---	---	---	---	---	---	1	EU. &Australia

Wired controller communication address

SW3-5	SW3-6	SW3-7	SW3-8	Indoor unit Address (Indoor unit address for one wired controller control more than one unit)
OFF	OFF	OFF	OFF	0 (master)
OFF	OFF	OFF	ON	1(slave)
OFF	OFF	ON	OFF	2(slave)
OFF	OFF	ON	ON	3(slave)
OFF	ON	OFF	OFF	4(slave)
OFF	ON	OFF	ON	5(slave)
OFF	ON	ON	OFF	6(slave)
OFF	ON	ON	ON	7(slave)
ON	OFF	OFF	OFF	8(slave)
ON	OFF	OFF	ON	9(slave)
ON	OFF	ON	OFF	10(slave)
ON	OFF	ON	ON	11(slave)
ON	ON	OFF	OFF	12(slave)
ON	ON	OFF	ON	13(slave)
ON	ON	ON	OFF	14(slave)
ON	ON	ON	ON	15(slave)

AM36LP2VHA AM48LP2VHA PCB 0151800106E

BM1 (1-ON, 0-OFF)								
Capacity (SW1-1→SW1-3)			Room card SW1-4	Running mode SW1-5	Unit Type			Description
SW1-1	SW1-2	SW1-3			SW1-6	SW1-7	SW1-8	
ON	OFF	ON	---	---	---	---	---	AM36LP2VHA
ON	ON	ON	---	---	---	---	---	AM48LP2VHA
---	---	---	ON	---	---	---	---	Room card valid
---	---	---	OFF	---	---	---	---	Room card invalid(default)
---	---	---	---	ON	---	---	---	Cool only
---	---	---	---	OFF	---	---	---	Cool and heat(default)
---	---	---	---		OFF	ON	OFF	Medium ESP DUCT
---	---	---	---		ON	ON	OFF	High ESP DUCT

Wired controller communication address

SW2-1	SW2-2	SW2-3	SW2-4	Indoor unit Address (Indoor unit address for one wired controller control more than one unit)
OFF	OFF	OFF	OFF	0 (master)
OFF	OFF	OFF	ON	1(slave)
OFF	OFF	ON	OFF	2(slave)
OFF	OFF	ON	ON	3(slave)
OFF	ON	OFF	OFF	4(slave)
OFF	ON	OFF	ON	5(slave)
OFF	ON	ON	OFF	6(slave)
OFF	ON	ON	ON	7(slave)
ON	OFF	OFF	OFF	8(slave)
ON	OFF	OFF	ON	9(slave)
ON	OFF	ON	OFF	10(slave)
ON	OFF	ON	ON	11(slave)
ON	ON	OFF	OFF	12(slave)
ON	ON	OFF	ON	13(slave)
ON	ON	ON	OFF	14(slave)
ON	ON	ON	ON	15(slave)

3. Outdoor PCB

PCB: 0151800054B

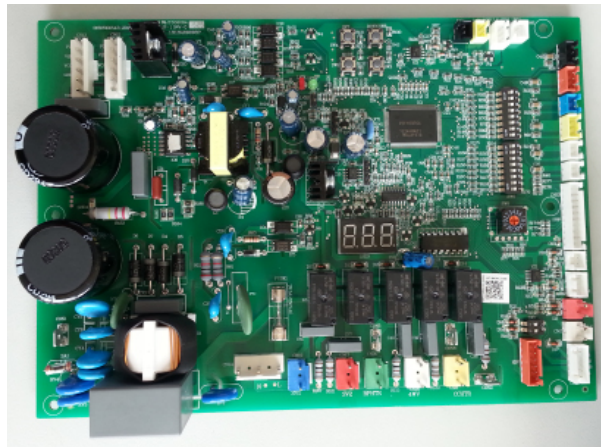

Power module: 0150401824

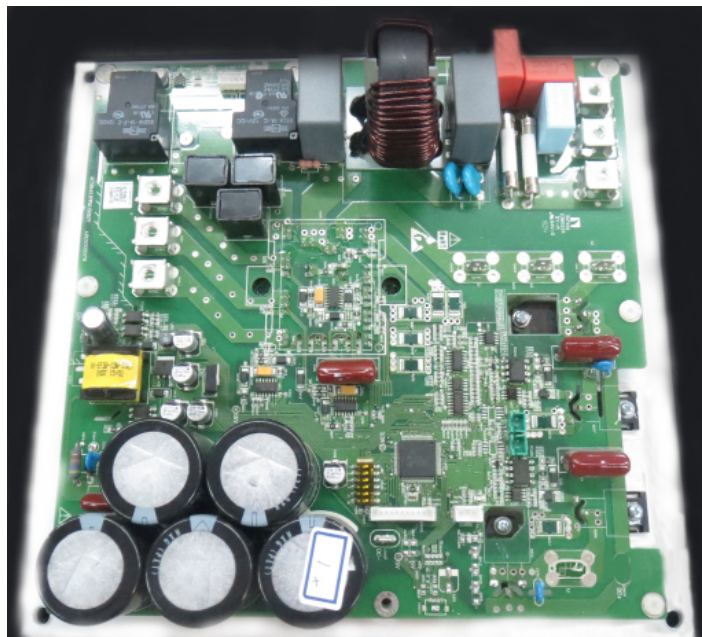

Outdoor Dip Switches

SW8: Dip switch setting

SW1-1	SW1-2	SW1-3	SW1-4	SW1-5	SW1-6	SW1-7	SW1-8	Description
OFF	----	----	----	----	----	----	----	Manually forced operation invalid(default)
ON	----	----	----	----	----	----	----	Manually forced operation valid
----	OFF	----	----	----	----	----	----	Manually forced heating(default)
----	ON	----	----	----	----	----	----	Manually forced cooling
----	----	OFF	----	----	----	----	----	Normal standby cost(default)
----	----	ON	----	----	----	----	----	Low stand by power cost
----	----	----	OFF	----	----	----	----	Water heater or heating only
----	----	----	ON	----	----	----	----	Unit as air conditioner (default)
----	----	----	----	OFF	----	----	----	Central control(default)
----	----	----	----	ON	----	----	----	BMS
----	----	----	----	----	OFF	----	----	Refrigerant R410A(default)
----	----	----	----	----	ON	----	----	Refrigerant R32
----	----	----	----	----	----	OFF	----	Defrost automatic(default)
----	----	----	----	----	----	ON	----	Defrost by time
----	----	----	----	----	----	----	OFF	Not for base station
----	----	----	----	----	----	----	ON	Base station application(default)

SW6 (1-ON, 0-OFF)								Unit address for central control
SW6-1	SW6-2	SW6-3	SW6-4	SW6-5	SW6-6	SW6-7	SW6-8	
0	0	0	0	0	0	0	0	0
0	0	0	0	0	0	0	1	1
0	0	0	0	0	0	1	0	2
0	0	0	0	0	0	1	1	3
0	0	0	0	0	1	0	0	4
0	0	0	0	0	1	0	1	5
0	0	0	0	0	1	1	0	6
0	0	0	0	0	1	1	1	7
----	----	----	----	----	----	----	----	----
1	1	1	1	1	1	1	1	255

SW8	Defination
0	1U24LP2VHA
2	1U36LP2VHA
5	1U48LP2VHA

4. Error Code

4.1 Failure code indoor unit

AL24LP2VHA AL36LP2VHA AL48LP2VHA

LED flash times of indoor PCB		LR.Receiver digital display	Contents of malfunction	Possible reasons
LED4	LED1			
0	1	01	Malfunction of indoor unit ambient temperature sensor	Sensor disconnected, broken, shorted, or at wrong position.
0	2	02	Malfunction of indoor unit piping temperature sensor	Sensor disconnected, broken, shorted, or at wrong position.
0	4	04	PCB EEPROM error	EEPROM chip disconnected, broken, or programmed incorrectly. PCB defective.
0	7	07	Abnormal communication between indoor and outdoor units	Poor wiring connections, faulty wiring, poor power supply, incorrect addressing of indoor units, malfunction of slave unit programming in MAXI system; faulty PCB.
0	8	08	Abnormal communication between wired controller (or IR receiver) and indoor unit	Wrong connection or wired controller broken, or PCB faulty
0	12	0C	Malfunction of drain system	Condensate pump disconnected or faulty, float switch a wrong position, disconnected or faulty, or a disconnection of the short circuit bridge
0	13	0D	Zero cross signal wrong	Zero cross signal not detected
0	14	0E	Indoor unit DC fan motor abnormal	Fan motor disconnected, faulty wiring, motor failure, or faulty circuit to motor

Note:

- The outdoor failure can also be indicated by the indoor unit, the checking method as follows: If the outdoor error code is M (DECIMAL), the indoor unit's I.R. receiver display will show the after converted hexadecimal code of "M+20" (DECIMAL), for example, if the outdoor error code is 2, the indoor unit I.R. receiver display will flash the error code 16 (2→2+20=22→change decimal 22 to hexadecimal code, get 16)
- LED4 is a red one on the indoor PCB, LED1 is a yellow one.
- To get much more details about the out door unit failure, please refer to the outdoor unit trouble shooting list.

Large Cassette Error Code Logic			
Cassette panel IR receiver digital display (flashing)	Corresponds to outdoor error code	Description of malfunction	Remarks
01	/	Malfunction of indoor unit ambient temperature sensor	Malfunction of indoor unit. Refer to indoor unit trouble shooting list to get more details
02	/	Malfunction of indoor unit piping temperature sensor	
04	/	PCB EEPROM failure	
07	/	Abnormal communication between indoor and outdoor units	
08	/	Abnormal communication between wired controller(or I.R .RECEIVER) and indoor unit	
0C	/	Malfunction of drain system (float switch open circuit)	
0D	/	Indoor unit Zero cross signal error	
0E	/	Indoor unit DC fan motor abnormal	
15	1	Outdoor main control PCB EEPROM malfunction	
16	2	PIM(power intelligent module)hardware overcurrent	
17	3	Compressor over current during deceleration	
18	4	Communication abnormal between control board and compressor driver module	
19	5	Compressor overcurrent detected by control board	
1A	6	DC voltage or AC voltage high	
1B	7	Compressor current sampling circuit fault	
1C	8	Discharge temperature too high	
1D	9	DC fan motor fault	
1E	10	Outdoor defrosting temp. sensor Te abnormal	
1F	11	Suction temp. sensor Ts abnormal	
20	12	Outdoor ambient temp. sensor Ta abnormal	
21	13	Discharging temp. sensor Td abnormal	
22	14	PFC circuit loop high voltage	
23	15	Communication abnormal between indoor unit and outdoor unit	
24	16	Restriction in discharge piping	
25	17	4-way valve abnormal	
26	18	Compressor motor desynchronizing	

Large Cassette Error Code Logic			
Cassette panel IR receiver digital display (flashing)	Corresponds to outdoor error code	Description of malfunction	Remarks
28	20	Indoor pipe temperature too high	Malfunction of outdoor unit. Refer to outdoor unit troubleshooting list for more details
2A	22	PFC circuit loop overcurrent	
2B	23	Temperature too high for compressor driver module	
2C	24	Compressor start failure	
2D	25	Input overcurrent of the drive module	
2E	26	Lack phase of the drive module power supply	
2F	27	Input current sampling circuit fault	
30	28	No wiring of the compressor	
39	37	Compressor overcurrent detected by compressor driver module	
3A	38	Drive module's ambient temp. sensor abnormal	
3B	39	Mid-condenser temp. sensor TC abnormal	
3E	42	High pressure switch abnormal(open circuit)	
3F	43	Low pressure switch abnormal(open circuit)	
40	44	Outdoor condenser temperatureTC too high	
41	45	System low pressure protection	

Note:
The outdoor failure can also be indicated by the indoor unit, the checkin gmethod as followings: If the outdoor error code is M(DECIMAL), the indoor unit's I.R. receiver display will show the after convert3erd hexadecimal code of "M+20"(DECIMAL)
For example, if the outdoor error code is 2, the indoor unit I.R. receiver display will flash the error code 16(2→2+20=22→change decmal 22 to hexadecimal code, get 16)

High Static Duct Models

AM24LP2VHA AM36LP2VHA AM48LP2VHA

LED flash times of indoor PCB		Wired controller display	Description	Possible reasons
LED4	LED3			
0	1	01	Malfunction of indoor unit ambient temperature sensor	Sensor disconnected, broken, shorted, or at wrong position.
0	2	02	Malfunction of indoor unit piping temperature sensor	Sensor disconnected, broken, shorted, or at wrong position.
0	4	04	PCB EEPROM error	EEPROM chip disconnected, broken, or programmed incorrectly. PCB defective.
0	7	07	Abnormal communication between indoor and outdoor units	Poor wiring connections, faulty wiring, poor power supply, incorrect addressing of indoor units, faulty PCB.
0	8	08	Abnormal communication between wired controller and indoor unit	Wrong connection or wired controller broken, or PCB hardware malfunction
0	12	0C	Malfunction of drain system	Condensate pump disconnected or faulty, float switch a wrong position, disconnected or faulty, or a disconnection of the short circuit bridge
0	13	0D	Zero cross signal wrong	Zero cross signal not detected
0	14	0E	Abnormal communication between main control PCB & fan motor drive	Fan motor disconnected, faulty wiring, motor failure, or faulty circuit to motor
0	15	0F	Fan motor overcurrent	Fan motor current too high
0	17	11	DC voltage high or low	DC voltage of the fan motor driver too high or too low
0	18	12	F.M.D temperature high	Fan motor driver over 95°C
0	19	13	Fan motor out of step	Wrong rotor location detected
M (≥1)	N (≥0)	/	Error of the outdoor unit	See note 1,2

4.2 1U24LP2VHA 1U36LP2VHA 1U48LP2VHA

Troubleshooting			
Error code	Malfunction Description	Diagnosis and Analysis.	Remark
1	EEPROM malfunction	EEPROM chip damaged or data wrong or related circuit damaged.	Non-resumable
2	PIM (power intelligent module) hardware over current	Input over current occurred been detected by PIM's hardware.	Resumable
3	Compressor over current during deceleration	Over current occurred during compressor deceleration period.	Non-resumable
4	Communication abnormal between control board and compressor driver module	Control board can not communicating with compressor driver module over 4 minutes	Resumable
5	Compressor overcurrent detected by control board	Compressor over current been detected by control board	Non-resumable
6	DC voltage or AC voltage high	AC power supply of the driver module get voltage over 280VAC or driver module get high DC-BUS voltage over 390VDC.	Resumable
7	Compressor current sampling circuit fault	The driver module's Compressor current sampling circuit damaged.	Non-resumable
8	Discharge temperature too high protection	Compressor discharge temperature over 115°C, error clear within 3 minutes if temperature goes down and lower than 115°C. Error status lock if it occurs 3 times in 1 hour.	Non-resumable
9	DC fan motor fault	DC fan motor damage or not connected or related circuit broken. Error status confirm and lock if occurs 3 times within 30 minutes.	Non-resumable
10	Outdoor defrosting temp. sensor Te abnormal	Sensor temperature been detected below -55°C or higher than 90°C or been detected as short circuit or open circuit..	Resumable
11	Suction temp.sensor Ts abnormal		
12	Outdoor ambient temp. sensor Ta abnormal	Sensor temperature been detected below -40°C or higher than 90°C or been detected short circuit or open circuit.	Resumable
13	Discharging temp. sensor Td abnormal	Sensor temperature been detected below -40°C or higher than 150°C or been detected short circuit or open circuit .	Resumable
14	PFC circuit loop high voltage	Overvoltage been detected in driver module's power factor correction circuit loop.	Resumable
15	Communication abnormal between indoor unit and outdoor unit	Outdoor unit control board can not communicating with indoor unit control board over 4 minutes.	Resumable
16	Lack of refrigerant or discharging pipe blocked	Discharge & suction temperature Td-Ts≥80°C after compressor started 10 minutes.Error status lock if it occurs 3 times in 1 hour.	Non-resumable
17	4-way vavle converse abnormal	Indoor pipe & indoor ambient temperature Tm-Tai≥5°C after compress- or started 10 minutes. Error status lock if it occurs 3 times in 1 hour.	Non-resumable
18	Compressor motor desynchronizing	Rotor desynchronizing occurred, caused by overload or load sharply fluctuating or compressor current sensor circuit abnormal or one of the inverter's gate drive signal missing.	Non-resumable

Error code	Malfunction Description	Diagnosis and Analysis	Remark
19	DC voltage or AC voltage low	AC power supply of the driver module get voltage lower than 155VAC or driver module get high DC-BUS voltage lower than 180VDC.	Resumable
20	Indoor pipe temperature too high protection	Indoor pipe temperature T_m over 63°C , error clear within 3 minutes if temperature goes down and lower than 52°C .	Resumable
22	PFC circuit loop overcurrent	Overcurrent been detected in power factor correction circuit loop.	Resumable
23	Temperature too high for compressor driver module	Compressor driver module's PIM temperature over 90°C , Error stat-us lock if it occurs 3 times in 1 hour.	Non-resumable
24	Compressor start failure	Compressor start failure been detected by driver driver module.	Non-resumable
25	Input overcurrent of the drive module	Input current of the compressor drive module higher than 32A (double fan model) or 27A (single fan) , Lock if it occurs 3 times in 1 hour.	Non-resumable
26	Lack phase of the drive module	Lack phase of the drive module's power supply.(three phase type)	Non-resumable
27	Input current sampling circuit fault	The driver module's input current sampling circuit damaged.	Resumable
28	No wiring of the compressor	No wiring between compressor and it's driver module.	Non-resumable
37	Compressor overcurrent detected by compressor driver module	Compressor phase U or V or W current over 27A (single phase model) or 19.1A (single phase model) occured during non-rated period.	Resumable
38	Drive module's ambient temp. sensor abnormal	The temperature detected is not within the range of -25°C to 150°C .	Resumable
39	Mid-condenser temp. sensor TC abnormal	The temperature detected is not within the range of -55°C to 90°C .	Resumable
42	High pressure switch abnormal	After compressor running for 3 minutes, switch been detected open circuit for 30seconds, Error lock if it occurs 3 times in 1 hour.	Non-resumable
43	Low pressure switch abnormal	After compressor running for 3 minutes, switch been detected uncon-nected for 60seconds or unconnected for 30seconds at standby.	Non-resumable
44	Outdoor condenser temperatureTC too high protection	The maximum temperature value of T_c and T_e is over 65°C , Error lock if it occurs 3 times in 30 minutes.	Non-resumable
45	System low pressure protection	The minimum temperature value of indoor pipe T_m and outdoor T_s is lower than -45°C at cooling mode or minimum temperature value of outdoor T_c and outdoor T_e is lower than -45°C .	Non-resumable

Note:

1. The outdoor control board's LED3 indicates the outdoor error code. for example, the error code 12, LED3 will display 12 and keep flashing.
2. Non-resumable means error will not clear unless: a. clean the fault factor b. Turn off the power supply and turn on again after point a achieved.
3. The indoor unit can also indictes the outdoor malfunction code too. Please refer to indoor unit manul to get the method.

4.3 Power Module Error Codes for 1U24LP2VHA 1U36LP2VHA

1. Drive Status Indication

LED	LED display Description	LED position
LED 601 (GREEN)	Flashing (on 1s, Off 1s) : Drive is operating normally Flashing (on 0.25s off 0.25s, flashes n times and then off 2s as a period) : Module board failure	Module board

2. Protection function

Protection style:

Protection style	Explanation	LED	LED display Description	ERROR Recovery
Shutdown protection	When voltage, temperature, or current reach the limit of the protection level, the unit will shut off, and the LED will display the error code.	LED 601 (GREEN)	Flashes n times, off 2s; (n is the error code)	Needs to keep the error information 2min, then ERROR Recovery

3. Shutdown Protection Error Codes

Error code	Hardware/software protection	Error Detail	Protection Level	Error symbol
1	Software	PIM module overheat	105°C and continued 5s	01H
2	Software	PIM temperature sampling failure	/	18H
3	Software	Overcurrent protection when limit frequency	/	02H
4	Hardware	Hardware protection PIM_INT	PIM_INT	04H
6	Software	DC under voltage	180V	05H
7	Software	DC high voltage	390V	06H
8	Software	Communication error	/	07H
9	Software	Output lack of phase	/	16H
10	Software	Preset	/	/
11	Software	U phase overcurrent	40A	0AH
12	Software	Compressor is out of step	/	0EH
13	Software	V phase overcurrent	40A	0CH
14	software	W phase overcurrent	40A	0DH
15	Software	Compressor startup failure	/	0FH
16	Software	Phase current sampling failure	/	09H
19	Software	AC input under voltage	155V	11H
20	Software	AC input overvoltage	280V	12H
21	Software	AC input overcurrent	35A	13H
22	Software	Input current sampling failure	/	08H
23		Preset		
24		Preset		
25		Preset		
27		Preset		
30		Preset		

Appendix A Protection function logic and protection level

PIM temperature protection

Temperature more than 105°C, and continue 5 seconds, then drive shutdown protection.

Compressor startup failure protection

The drive will attempt to start the compressor 5 times, at intervals of 15 seconds. When the drive is making five times the driving signal cannot normally drive the compressor, for the protection of the relevant parts, compressor immediately shut down, and the drive will have the compressor drive failure protection.

Limit frequency/shutdown protection

Compressor current protection:

Error Protection	Protection condition	Result symbol
Shutdown protection	Compressor phase current > compressor phase current shutdown protection current (RMS) , the compressor immediately stop, drive into the limited-frequency overcurrent protection.	
Limit frequency protection	Compressor phase current > compressor Phase current Limit frequency protection current (RMS) , the compressor will decrease the frequency by the 2Hz/sec rate.	Limit frequency protection
	After compressor decrease the frequency, compressor phase current limit frequency protection current (RMS) ≥ compressor phase current > compressor phase current protection recovery current (RMS) , forbid increase the compressor frequency.	Forbid increase the compressor frequency
Protection recovery	Compressor phase current ≤ Compressor phase current protection recovery current (RMS) , cancel the compressor limit frequency protection and normally operation	

Drive input current protection:

Error Protection	Protection Condition	Result symbol
Shutdown protection	Compressor phase current > compressor phase current shutdown protection current (RMS) , the compressor immediately stop, drive into the limited frequency overcurrent protection.	
Limit frequency protection	Compressor phase current > compressor Phase current limit frequency protection current (RMS) , the compressor will decrease the frequency by the 2Hz/sec rate.	Limit frequency protection
	After compressor decrease the frequency, compressor phase current limit frequency protection current (RMS) ≥ compressor phase current > compressor phase current protection recovery current (RMS) , forbid increase the compressor frequency.	Forbid increase the compressor frequency
Protection recovery	Compressor phase current ≤ Compressor phase current protection recovery current (RMS) , cancel the compressor limit frequency protection and normally operation.	

DC bus over/under voltage protection

Bus voltage>overvoltage shutdown value: the compressor stops, then switches into the bus overvoltage protection.

Bus voltage<overvoltage recovery value, cancel the bus overvoltage protection.

Bus voltage<under voltage shutdown value: the compressor stops, then switches into the bus under voltage protection.

Bus voltage<voltage recovery value, cancel the bus under voltage protection.

AC input over/under voltage protection

Drive comes with AC voltage detection, when input voltage is too low, the input current will be too high, damage can occur

Input voltage<under voltage shutdown value, the compressor stops, then switches into the input under voltage protection.

Input voltage>voltage recovery value, cancel the under voltage protection.

Drive comes with AC voltage detection, if the input voltage is too high, damage can occur.

Input voltage>over-voltage shutdown value, the compressor stops, then switches into the input overvoltage protection.

Input voltage<over-voltage recovery value, cancel input over-voltage protection.

Communication error:

Drive priority detects the model code after power is on for 30 seconds .

Compressor type	Model Code
TNB220FFEMC	0x02DC
TNB306FFEMC	0x02DD

If the model code is not within the model range or or the correct data is not received within the 30 seconds, the unit will go into a communications failure mode and will shut down.

When the correct data is within the model code range the error will be canceled.

Note: For debug mode, when the model code is not within the range of models, sentenced to communication failure; when the model code within the model range, then cancel the error

PFC switch value:

When PFC sampling current>PFC open switch current and the DC bus average voltage<PFC open switch voltage, then opening PFC;

When PFC sampling current<PFC off switch current, off PFC.

Protection value

Compressor type TNB220FFEMC:

No.	Error Description	Device Protection Value
1	Compressor phase current Limit frequency protection shutdown current value (RMS)	18A
2	Compressor phase current Limit frequency protection decrease frequency current value (RMS)	13A
3	Compressor phase current Limit frequency protection recovery current value (RMS)	10A
4	PIMTemperature shutdown protection	105°C
5	Drive input current limit frequency protection shutdown current value (RMS)	23A
6	Drive input current limit frequency protection decrease frequency current value (RMS)	18A
7	Drive input current limit frequency protection recovery current value (RMS)	13A
8	AC input overvoltage shutdown value	280V
9	AC input overvoltage recovery value	265V
10	AC input under voltage shutdown value	155V
11	AC input under voltage recovery value	185V
12	DC bus overvoltage shutdown value	390V
13	DC bus overvoltage recovery value	380V

No.	Error Description	Device Protection Value
14	DC bus under voltage shutdown value	180V
15	DC bus under voltage recovery value	200V
16	Communication shutdown protection time	30S
17	PFC open switch current (RMS)	8A
18	PFC open switch voltage	360V
19	PFC off switch current (RMS)	5A

Compressor type TNB306FFEMC:

No.	Error Description	Device Protection Value
1	Compressor phase current Limit frequency protection shutdown current value (RMS)	23A
2	Compressor phase current Limit frequency protection decrease frequency current value (RMS)	18A
3	Compressor phase current Limit frequency protection recovery current value (RMS)	14A

4.4 Power module error code checking for 1U48LP2VHA

1. Explanation of LED

LED Model	Explanation of LED Display	LED Location
LED 601 (Green)	Flashing (on,1s, off,1s) : driver works normally. Flashing (on,0.25s, off, 0.25s, flash several times, then off for 2 seconds) : power module failure.	Power module

2. Protection function

Category of protection:

Category	Explanation	LED	LED Display Description	Error Recovery
Shutdown protection	When the voltage, current, temperature, etc. to meet the shutdown protection Level, drive immediately stop output, and LED display fault information, and upload the error symbol	LED 601 (GREEN)	Flashes n times, off 2s; (n is the error code)	Needs to keep the error information 2min, then error Recovery

3. Protection error lists

Error Code	Hardware/software Protection	Error Detail	Protection Level	Display Symbol
1	Software	PIM module overheat	105°C and continued 5s	01H
2	Software	PIM temperature sampling failure	/	18H
3	Software	Overcurrent protection when limit frequency	/	02H
4	Hardware	Hardware protection PIM_INT	PIM_INT	04H
6	Software	DC under voltage	180V	05H
7	Software	DC high voltage	390V	06H
8	Software	Communication error	/	07H
9	Software	Output lack of Phase	/	16H
10	Software	Reserved	/	/
11	Software	U phase overcurrent	40A	0AH
12	Software	Compressor is out of step	/	0EH
13	Software	V phase overcurrent	40A	0CH
14	software	W phase overcurrent	40A	0DH
15	Software	Compressor startup failure	/	0FH
16	Software	Phase current sampling failure	/	09H
19	Software	AC input under voltage	155V	11H
20	Software	AC input overvoltage	280V	12H
21	Software	AC input overcurrent	35A	13H
22	Software	Input current sampling failure	/	08H
23		Preset		
24		Preset		
25		Preset		
27		Preset		
30		Preset		
32	Software	PFC overcurrent of	75A	14H
34	Software	PFC high voltage	430V	15H

Appendix A Protection function logic and protection level

PIM temperature protection:

Temperature more than 105°C, and continue 5 seconds, then drive shutdown protection.

Compressor startup failure protection:

The drive will attempt to start the compressor 5 times, at intervals of 15 seconds. When the drive is making five times the driving signal cannot normally drive the compressor, for the protection of the relevant parts, compressor will immediately shut down, and the drive will have the compressor drive failure protection.

Limit frequency/shutdown protection

Compressor current protection:

Error Protection	Protection Condition	Result Symbol
Shutdown protection	Compressor phase current > compressor phase current shutdown protection current (RMS) , the compressor immediately stop, drive into the limited frequency overcurrent protection.	
Limit frequency protection	Compressor phase current > compressor Phase current Limit frequency protection current (RMS) , the compressor will decrease the frequency by the 2Hz/sec rate.	Limit frequency protection
	After compressor decrease the frequency, compressor phase current limit frequency protection current (RMS) ≥ compressor phase current > compressor phase current protection recovery current (RMS) , forbid increase the compressor frequency.	Forbid increase the compressor frequency
Protection recovery	Compressor phase current ≤ Compressor phase current protection recovery current (RMS) , cancel the compressor limit frequency protection and normally operation.	

Input current protection of driver:

Error Protection	Protection Condition	Result Symbol
Shutdown protection	Compressor phase current > compressor phase current shutdown protection current (RMS) , the compressor immediately stop, drive into the limited frequency overcurrent protection.	
Limit frequency protection	Compressor phase current > compressor Phase current limit frequency protection current (RMS) , the compressor will decrease the frequency by the 2Hz/sec rate.	Limit frequency protection
	After compressor decrease the frequency, compressor phase current limit frequency protection current (RMS) ≥ compressor phase current > compressor phase current protection recovery current (RMS) , forbid increase the compressor frequency.	forbid increase the compressor frequency
Protection recovery	Compressor phase current ≤ Compressor phase current protection recovery current (RMS) , cancel the compressor limit frequency protection and normally operation	

DC bus over/under voltage protection:

Bus voltage > overvoltage shutdown value, the compressor stop, then drive into the bus overvoltage protection.

Bus voltage < overvoltage recovery value, cancel the bus overvoltage protection.

Bus voltage < under voltage shutdown value, the compressor stop, then drive into the bus under voltage protection.

Bus voltage > voltage recovery value, cancel the bus under voltage protection.

AC input over/under voltage protection:

Drive come with AC voltage detection, avoid the input voltage is too low, cause the input current is too high, damage the device.

Input voltage < under voltage shutdown value, the compressor stop, then drive into the input under voltage protection.

Input voltage > voltage recovery value, cancel the under voltage protection.

Drive come with AC voltage detection, avoid the input voltage is too high, damage the device.

Input voltage > overvoltage shutdown value, the compressor stop, then drive into the input overvoltage protection.

Input voltage < overvoltage recovery value, cancel input overvoltage protection.

Communication error:

Drive priority detect the model code after power on .the 30s after power on is the time for the model code setting.

And need to complete the model code setting within this 30s, if setting completely, are not allowed to change.

Compressor type	Model code
MNB42FDAMC	0x03DE

If model code is out of model range or no right communication data is received within 30s, communication failure is confirmed, execute stop protection under communication failure, in the meanwhile, relevant error code is sent back.

When communication is confirmed, if right data is received again and within normal range, error is removed.

Remarks: for debugging mode, when model code is not within model range, communication error is confirmed, when model code is within model range, error is removed.

PFC switch value

When PFC sampling current > PFC open switch current and the DC bus average voltage < PFC open switch voltage, then opening PFC;

When PFC sampling current < PFC off switch current, off PFC.

Protection value

5. Instructions of parameters & Checking Error Codes

5.1 From where to do the parameters checking work?

Location of LED and button switches which on the outdoor main control PCB

5.2 Where are the digital LED display and the button switches?

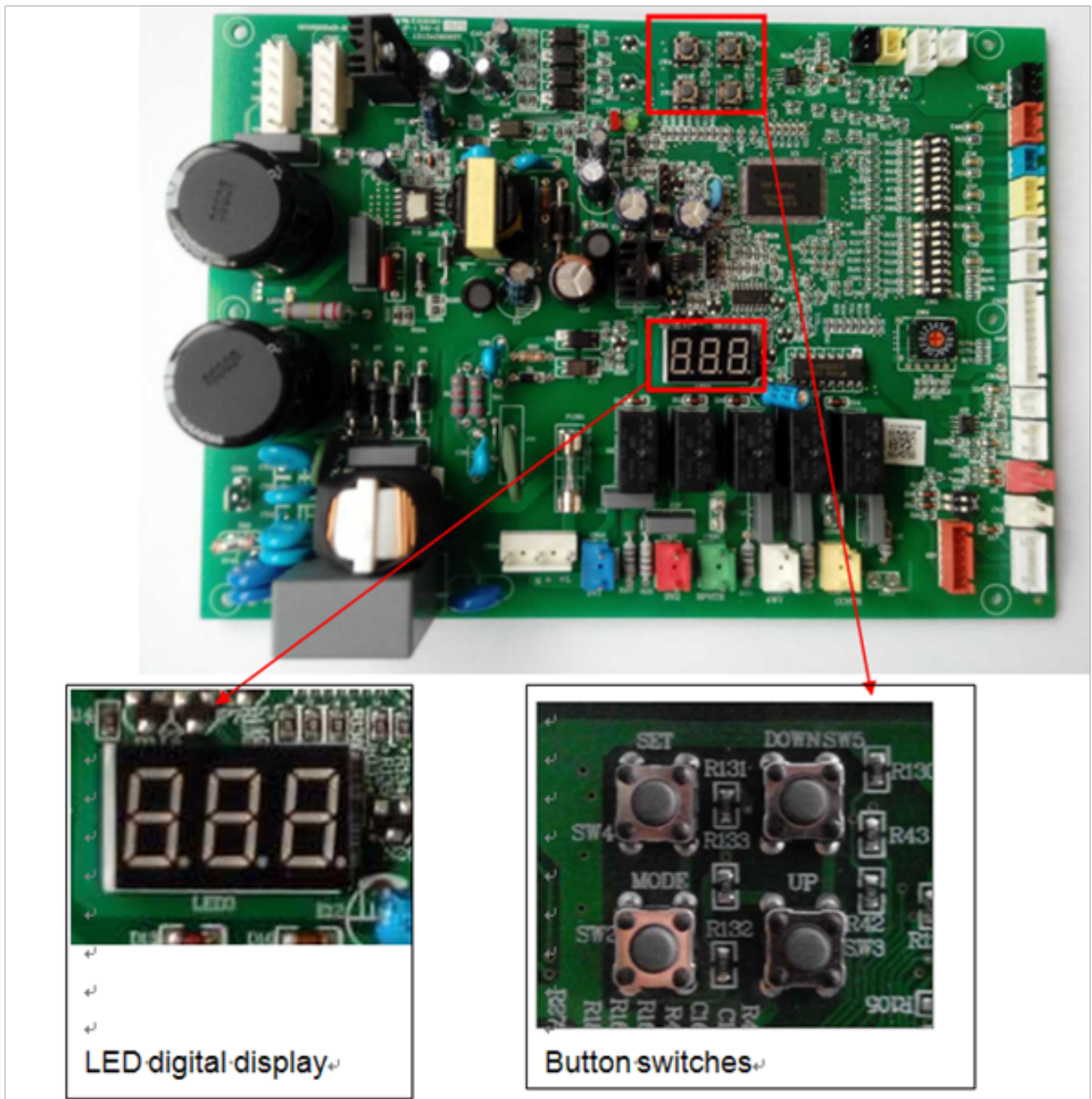

5.3 What does the Default Display at non-checking mode?

a. When outdoor unit gets power, the LED digital display will show the model code first, as following list.

MODEL	MODEL CODE	DISPLAY
1U24LP2VHA	24.1	24.1
1U36LP2VHA	36.1	36.1
1U48LP2VHA	60.2	60.2

b. Then after step a, if the communication between indoor and outdoor unit is correct, the LED digital display will show the quantity of indoor units.

For single splits system, it will show 1UN.



For a multi system (future) it will show 2UN or 3UN or 4UN



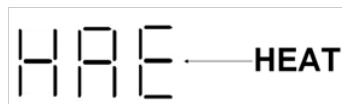

c. Then after step b and if has reached the outdoor unit's start time, the LED digital display will indicate the indoor unit's setting mode, cool or heat. This will be displayed for 5 seconds.

d. Then after step c and it will show the speed of the compressor rotor, 000 stands for speed is 0 RPS, 15 stands for 15 RPS, 49 stands for 49 RPS, and so on.

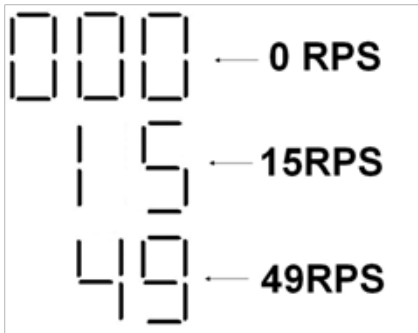

e. After Step D, when the indoor temperature reaches the set point, the outdoor unit will shut off and the LED display will be 000. 30 seconds later the LED will shut off. If the unit is shut off manually via the controller, the LED will display OFF for 30 seconds then will go out.

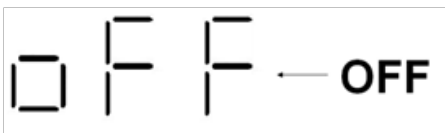

5.4 Checking the Parameters

Step1: Press and hold the MODE button for 5 seconds and release, then The LED display will show the current mode and will be flashing.

Step2: Press and hold the SET button for 3 seconds then release, The LED display will keep MODE lighted without flashing..

Step3: Press and hold the SET button for 3 seconds again then release, The LED will display FRQ and will flash the present speed of the compressor.

Step4: Scroll pages to view the other parameters by using UP or DOWN button

Fig. 4.1 or Fig. 4.2 shows steps above.

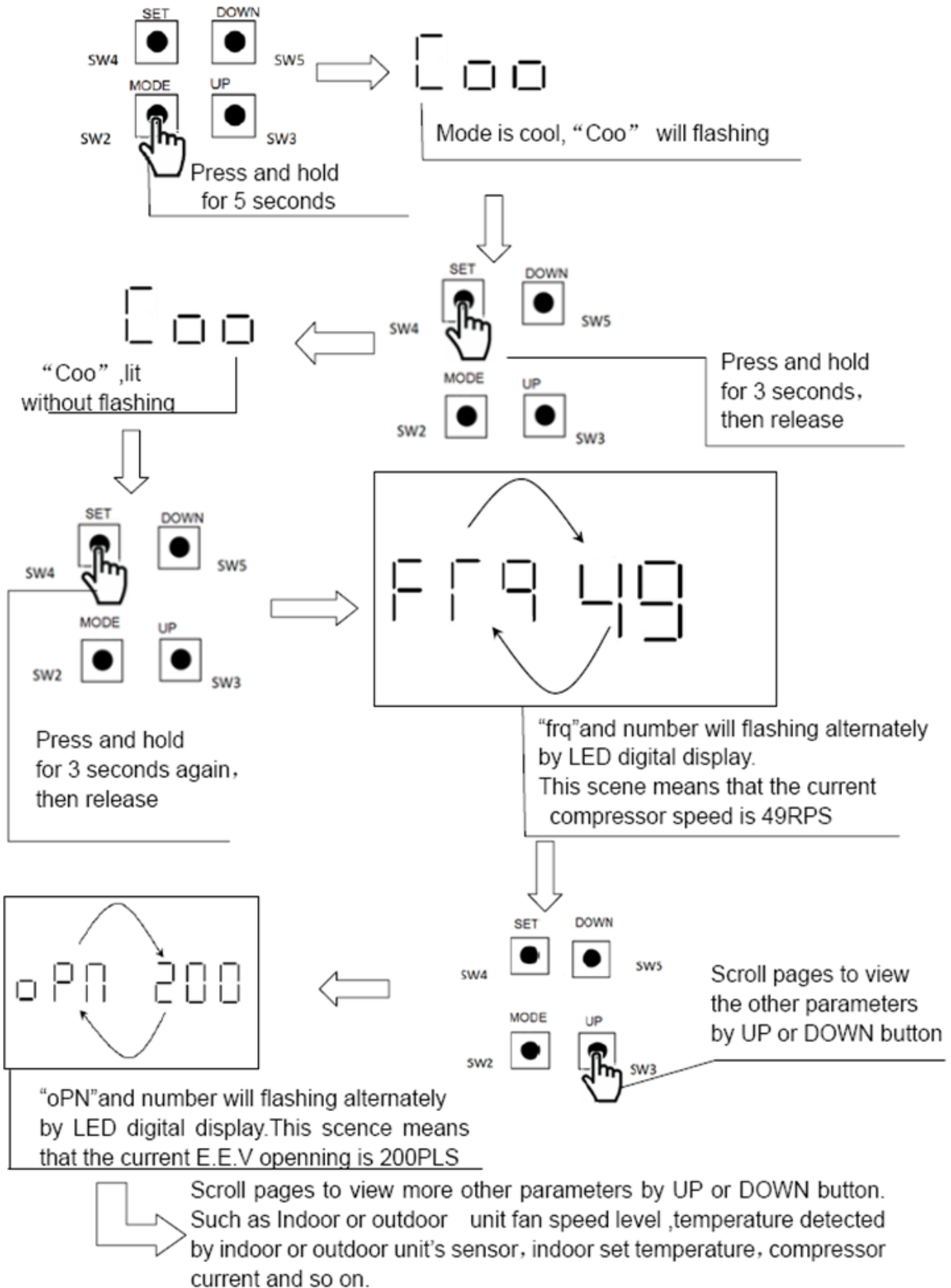

Fig.4.1

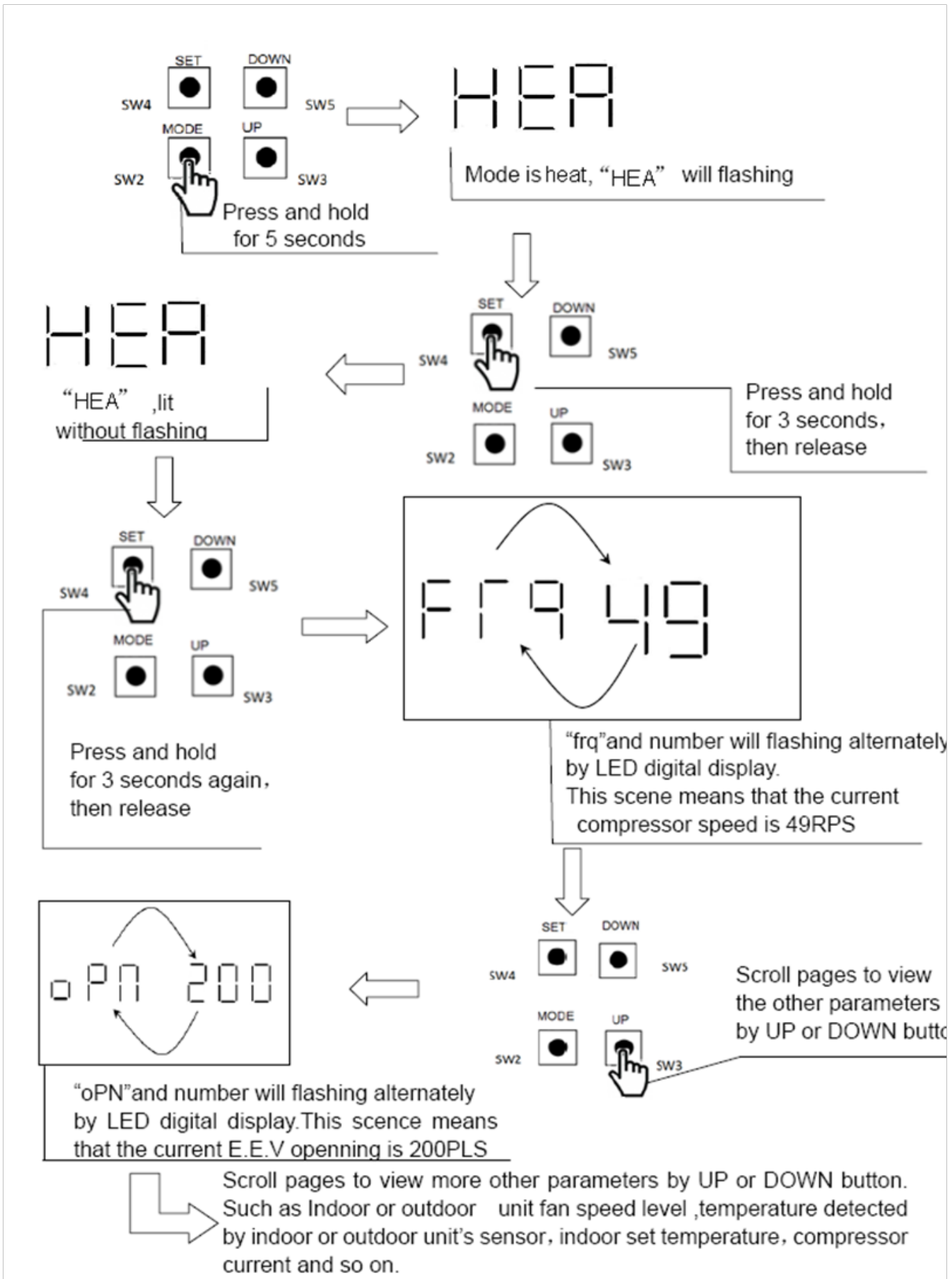

Fig.4.2

5.5 Outdoor Unit LED Display

No.	Symbol	LED Digital Display	Explanation
1	Coo	Coo	Cool mode
2	HEA	HEA	Heat mode
3	Fan	FAN	Fan mode
4	rrC	rrC	Refrigerant Recovery
5	Stb	Stb	Manually forced stand by
6	OFF	OFF	Compressor at OFF status
7	dIA	dIA	Diagnose
8	dEF	dEF	Manually forced defrost
9	pAr	pAr	Parameters checking
10	Co.N	Co.N	Cool mode of EER test condition
11	Co.A	Co.A	Cool mode of SEER test condition A
12	Co.b	Co.b	Cool mode of SEER test condition B
13	Co.C	Co.C	Cool mode of SEER test condition C
14	Co.d	Co.d	Cool mode of SEER test condition D
15	Co.E	Co.E	Cool mode of SEER test condition E
16	Co.F	Co.F	Cool mode of SEER test condition F
17	Co.H	Co.H	Cool mode of SEER test condition F
18	CO.I	CO.I	Cool mode of SEER test condition I
19	CO.J	CO.J	Cool mode of SEER test condition J
20	Ht.N	Ht.N	Heat mode of EER test condition
21	Ht.A	Ht.A	Heat mode of SCOP test condition A
22	Ht.b	Ht.b	Heat mode of SCOP test condition B
23	Ht.C	Ht.C	Heat mode of SCOP test condition C
24	Ht.d	Ht.d	Heat mode of SCOP test condition D
22	Ht.E	Ht.E	Heat mode of SCOP test condition E

No.	Symbol	LED Digital Display	Explanation
23	Ht.F	Ht.F	Heat mode of SCOP test condition F
24	Ht.H	Ht.H	Heat mode of SCOP test condition H
25	Ht.I	Ht.I	Heat mode of SCOP test condition I
26	Ht.J	Ht.J	Heat mode of SCOP test condition J
27	quit	quit	Quit
28	Frq	Frq	Frequency (speed of compressor, equals revolutions per second (RPS)) .
29	opN	opN	Electronic expansion valve opening
29	I.FN	I.FN	Indoor unit fan speed level
30	o. FN	o. FN	Indoor unit fan speed level
31	tAo	tAo	Temperature of outdoor ambient
32	tc	tc	Temperature of outdoor condenser
33	td	td	Temperature of outdoor discharge
34	tE	tE	Temperature of outdoor defrost
35	tS	tS	Temperature of outdoor suction
36	tdr	tdr	Temperature of compressor driver module
37	ldr	ldr	Current of the compressor
38	tH	tH	Temperature of heat water (reserved)
39	tAI	tAI	Temperature of indoor ambient
40	TCI	TCI	Temperature of indoor condenser
41	tSt	tSt	Setting temperature on indoor unit
42	UN	UN	UN=UNIT, 1UN means with 1 indoor unit: 2UN means with 2 indoor unit, MAXI application
43	r32	r32	Refrigerant R32
44	OiL	OiL	Unit gets compressor oil recycling mode

5.6 Checking current outdoor unit error code

If there is malfunction on the outdoor unit, the LED digital display will flashing like this repeating pattern:



Example:

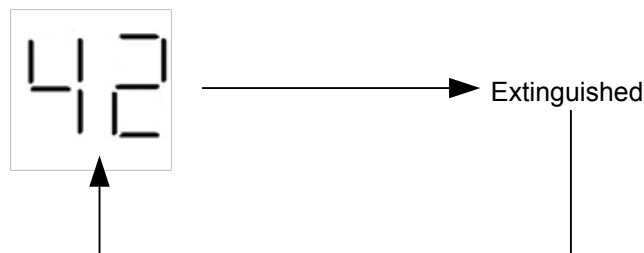

For an explanation of error codes, refer to the outdoor unit troubleshooting guide.

5.7 View previous error record (diagnosis mode)

Step1: Press and hold the MODE button for 5 seconds and release, then the LED digital display will show the current mode and will keep flashing.

Step2: Scroll up or down to view other modes.

Step3: Find mode "dig", press and hold the SET button for 3 seconds, then release.

Step3: When DIG is displayed, press and hold the SET button for 3 seconds then release. The LED will display the last recorded error code.

Step4: Scroll pages to view the other last 10 times error code by using the UP or DOWN button. If only N ($N \leq 10$) error has been recorded,, you can just find last N times error record.

Fig.7.1 shows steps above.

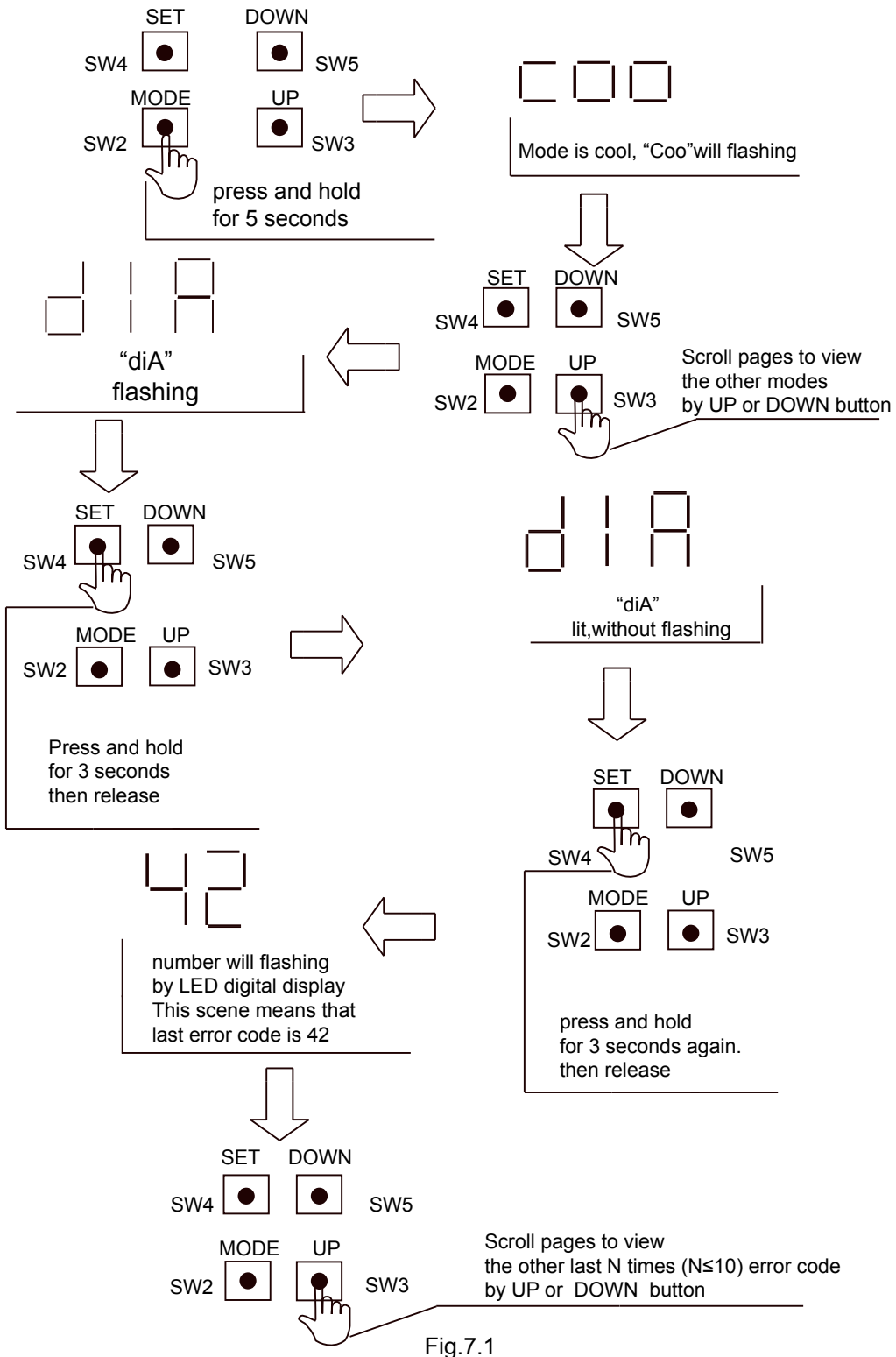

5.8 How to quit the parameters checking mode or diagnosis mode

Step1: Press and hold the MODE button for 15 seconds then release, then the LED digital display will show "QUT".



Step2: Press the SET button to quit the parameters checking mode or diagnosis mode.

6. Functions

6.1 Indoor unit:

6.1.1 Dehumidification operation (no humidity sensor)

1. The indoor unit will stop and send a signal to shut off the outdoor unit when $T_{ai} < 60^{\circ}\text{F}$
NOTE: I do not have a degree symbol, so I used the """. Please insert the degree symbol.
2. While in cooling mode, the indoor unit will send a call for cooling to the outdoor unit when $T_{ai} > T_{set} + 2$ degrees F.
3. When $T_{set} < T_{ai} \leq T_{set} + 2$ degrees F,,the indoor unit will send a dehumidification signal to the outdoor unit to start the compressor. The unit will run for 10 minutes in low fan speed then shut off for 6 minutes. When it stops it will send stopping signal to outdoor. When indoor unit failure, it will run 10 minutes in low speed and stop 6 minutes. Timing cycle keep the same. Slave units determine the fan speed through the state what outdoor sent.
4. When the room temperature is less than or equal to the set temperature, the indoor fan will operate on low speed and shut off the compressor.

6.1.2 Auto running:

1. When entering AUTO for the first time, the operating mode will be decided by the outdoor unit mode, the room temperature, and the set temperature. For example; if T_{ai} is equal to or greater than T_{set} , the unit will enter the cooling mode. If $T_{ai} < T_{set}$ the unit will enter the heating mode.
2. If the system is in the cooling mode and it has been off for 15 minutes, and $T_{ai} + 1 + T_{dif} < T_{set}$, the unit will start the heating mode.
3. If the system is in the heating mode and it has been off for 15 minutes, and T_{ai} is greater than or equal to $T_{set} + 1 + corrected + T_{dif}$, the unit will start the cooling mode.
4. The unit will enter the SLEEP function (if set) in both heating and cooling modes, yet will not change modes after 15 minutes of run time as outlined above.
5. Changing from heating to cooling while in the AUTO mode can only occur within 15 minutes after the compressor stops.

6.1.3 Indoor fan control:

1. Auto fan speed control

Cooling mode $\Delta T = T_{ai} - T_{set}$; heating mode $\Delta T = T_{set} - T_{ai}$

*First time to enter auto fan mode, if $\Delta T > 2$, choose high speed; $\Delta T \leq 0$, choose low speed, another choose middle speed. If temperature sensor is off ,choose low speed. (1 degree transformation temperature difference)

When the speed mode is auto high speed, if $\Delta T < 2$, the speed mode will change to auto middle speed.

When the speed mode is auto middle speed, if $\Delta T < 0$, the speed mode will change to auto low speed; if $\Delta T > 3$, the speed mode will change to auto high speed.

When the speed mode is auto low speed mode, if $\Delta T > 1$, the speed mode will change to auto middle speed.

The speed transformation under auto speed mode: It will delay 3 minutes from high speed to low speed and no delay from low to high.

Salve units determine the fan speed according to the state what outdoor has sent in the auto speed mode.

2. Cold air prevention control

In heating mode, the indoor fan running state is decided by indoor coil temperature (T_m) after compressor starts.

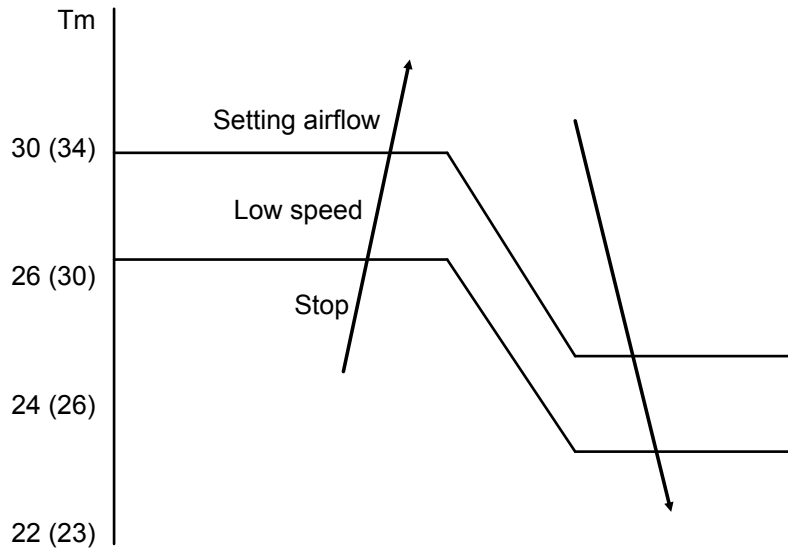

Note:

The numbers in the brackets is the temperature control point when the outdoor temperature is more than 10 degrees.

3. After-heat control:

When the compressor is off or the unit is off in the heating mode, the indoor fan will run for a maximum of 50 seconds in the low speed until the conditions in the above table are satisfied.

4. Cold air prevention during defrost:

When a call for defrost is received, the indoor fan will run in the after-heat mode for 20 seconds in low speed before stopping. After the defrost cycle is complete, the fan will begin the cold air prevention cycle.

6.1.4 Anti-freeze:

The outdoor unit LED will display the anti-freeze protection mode. The indoor unit will not, as this function is not a fault. The unit will end this mode automatically.

Anti-freeze protection of indoor unit in cooling mode

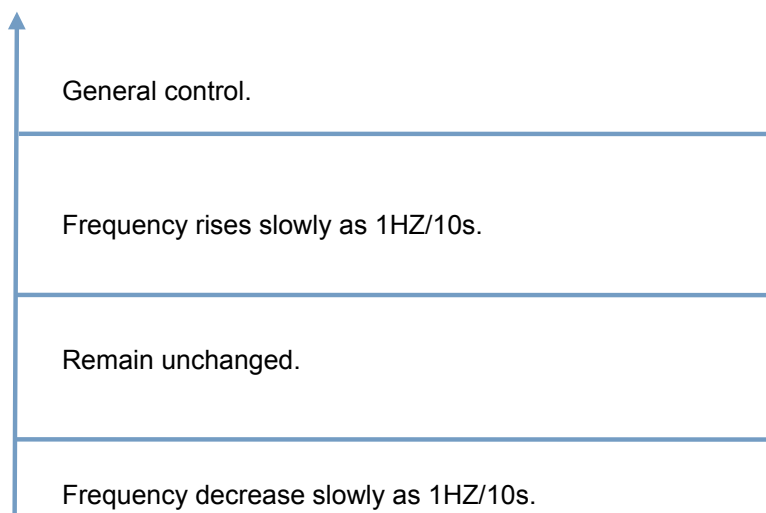

When $TM < 6^{\circ}\text{C}$, the compressor frequency will decrease at the speed of 1HZ/10s;

When TM start to rise again, and $6^{\circ}\text{C} \leq TM \leq 8^{\circ}\text{C}$, the compressor frequency will remain unchanged.

When $8^{\circ}\text{C} < TM \leq 10^{\circ}\text{C}$, the compressor frequency will rise at the speed of 1HZ/10s.

When the state of $TM < 2^{\circ}\text{C}$ lasts for 10s after 6 minutes of the startup of the compressor, or the state of $T < -20^{\circ}\text{C}$ (E) lasts for more than 2 hours in cooling mode, the compressor will stop. The unit will shut down for 5 minutes and the temperature of the coil rise to 10°C (E), it will be back up and running.

6.1.5 Control of float switch and condensate pump:

1. If in COOL or DRY mode: Compressor running (Thermal ON), then condensate pump is energized
 - When compressor stops (Thermal OFF), condensate pump runs for an additional 5 minutes
2. If in COOL or DRY modes and compressor is running (Thermal ON) and the float switch opens for 5 minutes
 - Compressor will stop, the pump will continue to run
 - If the float switch does not close, error code will display and pump continues to run
 - If the float switch does close, the pump will continue to run for 5 additional minutes
3. During standby (Thermal OFF) in COOL/DRY modes or in HEAT and FAN modes and float switch opens for 2 seconds the condensate pump is energized.
 - If the float switch closes, the pump will run an additional 5 minutes
 - If the float does not close, the pump continues to run and error code is displayed

Note: When installing, the condensate discharge port at the top of the water pump must be connected with drain pipe.

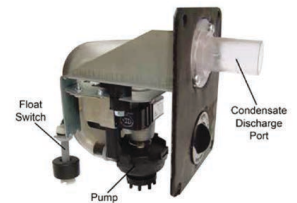

6.1.6 Emergency switch

1. Emergency switch operation

If the emergency switch is pressed when shutting down the system, the set temperature is locked at 75 degrees F. Pressing the switch again during start-up will return the system to normal.

2. Test run

To enter the test mode, press the emergency button for 5 seconds until two beeps are heard then release. The unit will maintain the last mode it was in before the shutdown. If in cooling, the temperature will be locked at 61 degrees F with high speed fan. Heating will be locked at 86 degrees F with high speed fan. To disable the test mode, press the emergency button again or use the wired or remote controller.

6.1.7 Room card control (default is valid)

Room card invalid: if room card is invalid, using room card to turn ON/OFF (ON when close and OFF when open) is valid, similar function to other controller.

Room card valid: if room card is valid, indoor will operate only when room card closes and then receives ON order from other controllers.

6.1.8 Auto restart function:

1. When using wired controller: auto restart function is default valid (no need to set)
2. With the remote controller, press the SLEEP button 10 times within 5 seconds. The controller will beep 4 times then enter the auto restart function. To exit, press the SLEEP button 10 times within 5 seconds. The controller will beep 2 times then exit auto restart.

Auto restart default memory: ON/OFF/MODE/FAN/SET TEMP/HEALTH/SWING. If the timer or sleep functions are set, they will be canceled when power is reapplied.

6.1.9 Forced defrost:

1. When using remote controller: when outdoor in heating or off state, set high fan, 86 degrees F, press sleep key 6 times in 5 seconds, and indoor beeps 3 times to enter manual defrosting.
2. When using wired controller: it will receive corresponding forced defrost signal and enter defrost.

6.1.10 Timing operation:

- 1) When using wired controller, unit will be controlled ON/OFF by wired controller
- 2) When using remote controller, unit will be ON/OFF according to set time by remote controller and current time.

6.1.11 Sleeping function:

- 1) When using wired controller, unit will be controlled ON/OFF by wired controller
- 2) When using remote controller, press sleep key to set sleep function including sleeping in heating and sleeping in cooling. After setting sleeping function and then shift mode, sleeping will recount.

6.1.12 Swing control:

- 1) When choosing 24k Cassette:

When powering on and initializing, it will Fully open for positioning, and then enter basic opening, fan motor operating after blade moving to right position.
- 2) When choosing 36k/48k cassette, swinging will be controlled by invisible LED.

It will swing according to default position when first powering on, and will swing according to swing position before turning off.

6.1.13 External static pressure setting method

There are 2 ways to achieve the external static pressure setting:

A. by Infrared remote controller

B. by wired controller.

MOEDL	Static Pressure Level (N)	Externalstatic Pressure	Select by Infrared Remote Controller	Select By Wired Controller
AM36LP2VHA AM48LP2VHA	1	25Pa	YR-HBS01 +RE-02→FAN mode ,fan speed high→press HEALTH button 4+N times($1 \leq N \leq 10$,integer) within 12 seconds	Select static pressure Level N by the display interface
	2	37Pa		
	3	50Pa		
	4	70Pa		
	5	90Pa		
	6	100Pa		
	7	110Pa		
	8	120Pa		
	9	130Pa		
	10	150Pa		

A.Static selection via remote:

1. Prepare: Infrared remote controller YR-HBS01 , infrared remote receiver RE-02(plug RE-02 connector to indoor PCB CN29)

2. Method:

Step 1: set the remote controller in the high speed FAN mode.

Step 2: then aim the remote controller at the infrared remote receiver RE-02, press HEALTH button 4+N times($1 \leq N \leq 10$,integer) within 12 seconds ,The receiver will beep N+1 times indicating the static pressure level has been set.

Note: For Infrared remote controller YR-HBS01, press ON/OFF button to set the controller at the OFF position. Open the cover of the controller and press the FRESH button to enter the FAN mode interface.

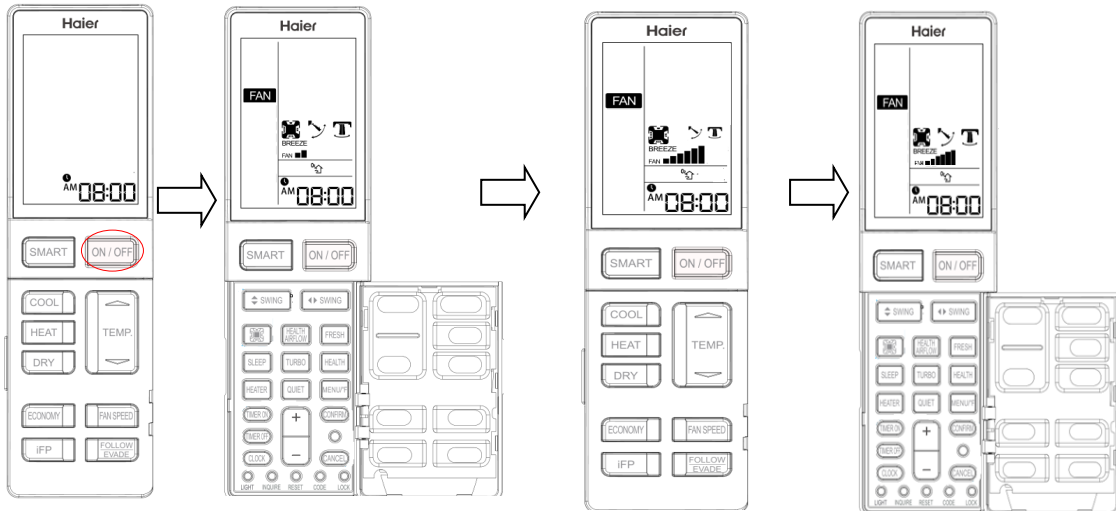

B.Static selection via wired controller:

1. Prepare: wired controller YR-E17, plug wired controller connector to indoor PCB CN3

2. Method:

2.1 In the state of ON and non screen saving state, press Fan + Set keys for 5s to enter static pressure grade adjustment.

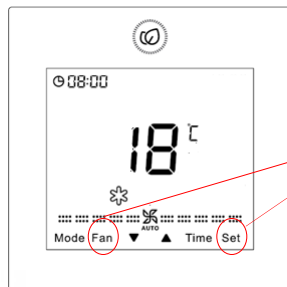

Press together and hold for 5 seconds

2.2 Static pressure icon will flash and the current setting will be displayed

2.3. Press key ▼ ▲ to change static pressure grade $N(1 \leq N \leq 10, \text{integer})$, then press Set key to confirm.

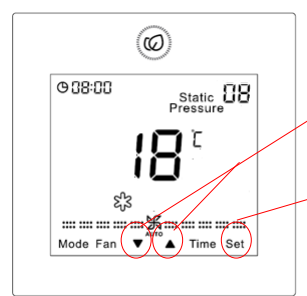

Use these buttons to adjust static pressure level numbers.

press Set key to confirm.

6.2 Outdoor unit

6.2.1 Compressor discharge temp. (TD) high temp. protection function.

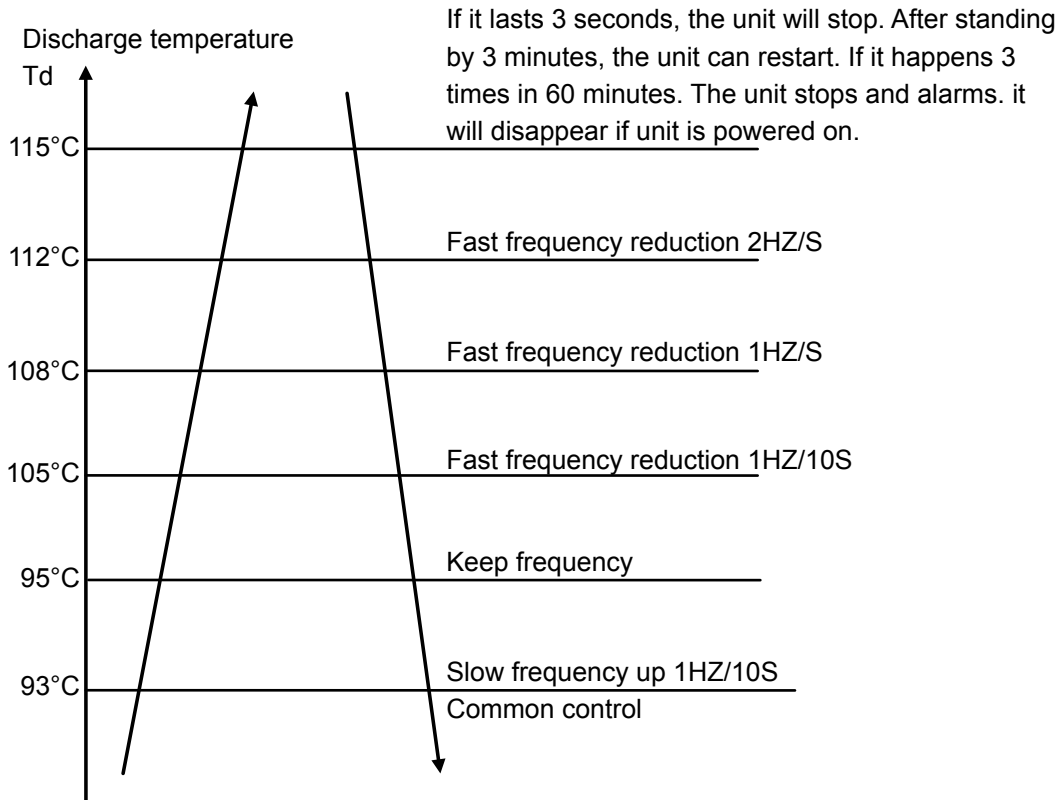

6.2.2 Condenser overheat protection

When cooling, compare TC with TE. Choose the bigger one, TC'. $TC' = \text{MAX.}[TC, TE]$. You can control the high pressure through controlling TC'.

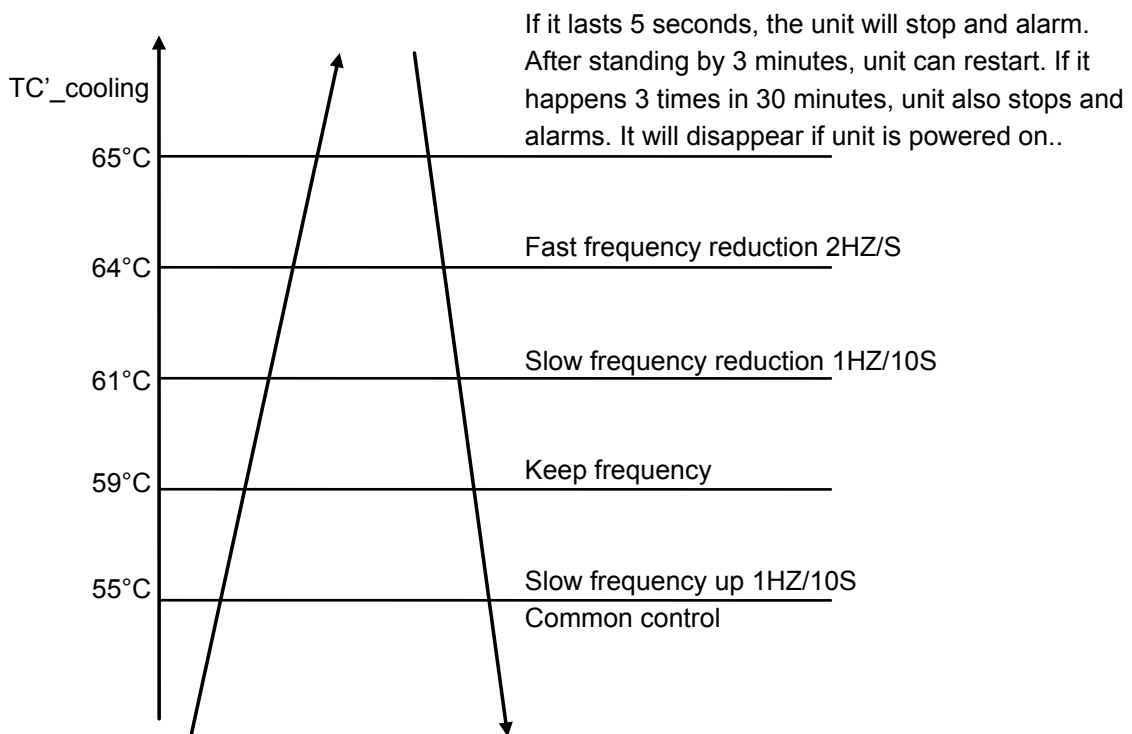

6.2.3 Low pressure protection

The low pressure is controlled by simulating evaporating temperature:

When cooling, compare the evaporating temp. with the compressor suction temp. and choose the lower one (Teva c) to compare.

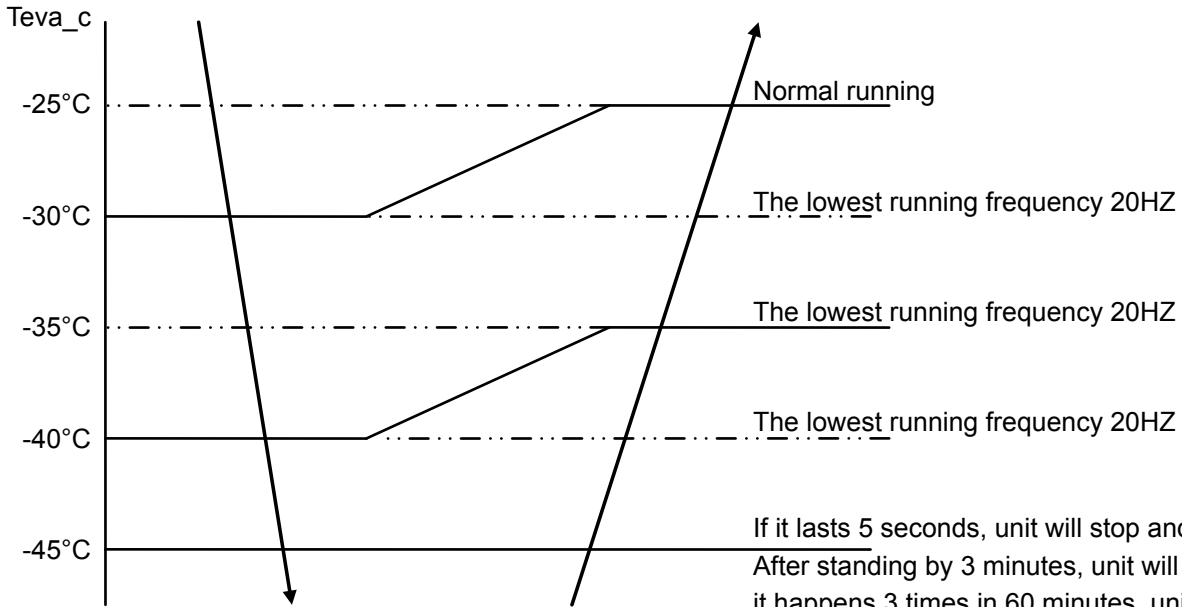

In the heating mode, low pressure protection is realized by the lower temperature (Teva h) from a comparison of the defrost temperature (Te) and ambient (Tc) temperature.

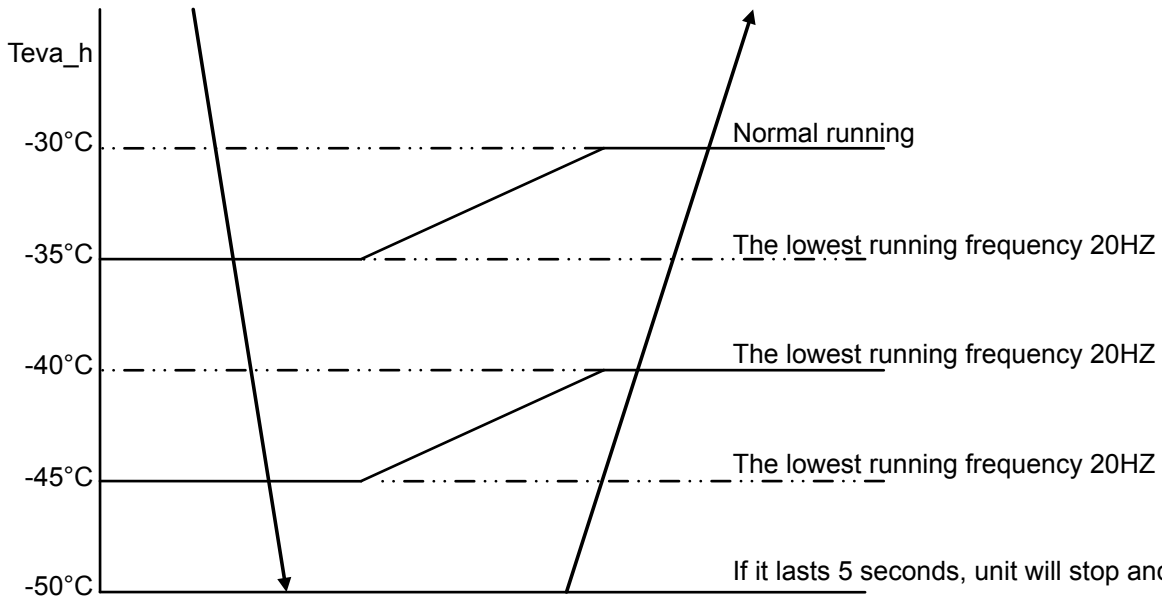

6.2.4 Oil return control

Control purpose: Oil return control ensures oil regularly returns to the compressor has been operating at long periods of time at a low speed.

Condition:

The oil return mode will be entered when the compressor has been operating for at least 5 hours at a speed lower than parameters C HZ (E) and the temperature TC is lower than 122 degrees F. The 5 hour timing will pause if the unit is changing modes or stopped by an error code. Timing will resume when the compressor restarts. Timing will automatically reset when the compressor is operating at a speed higher than B HZ (E) for more than 10 minutes. Timing will reset following a defrost period during the heating mode..

After oil return, the timer is reset.

Process control chart of oil return:

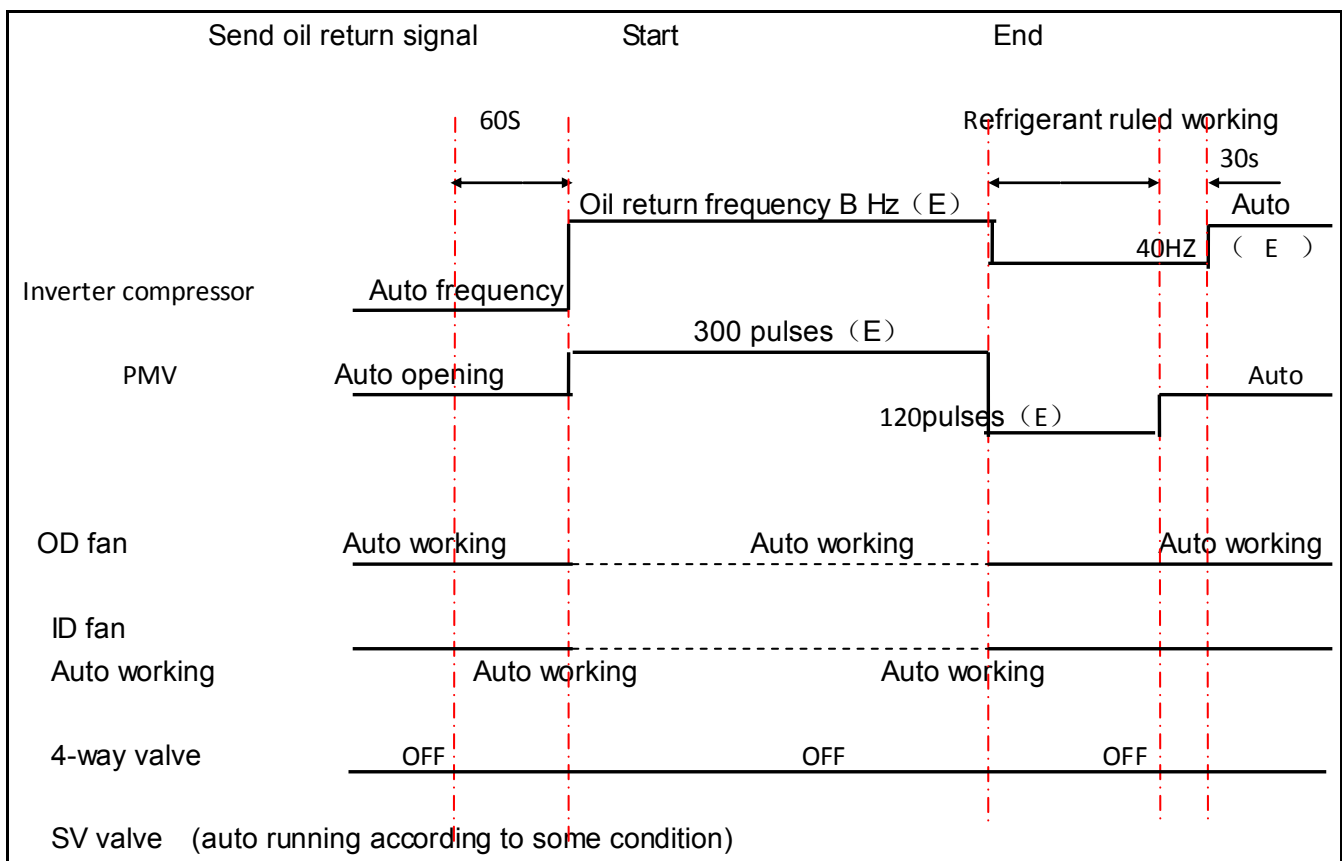

Conditions following the oil return cycle

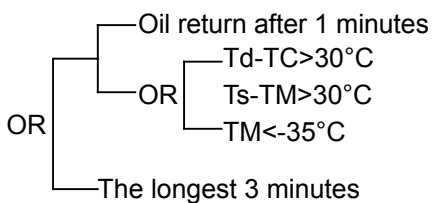

Process control chart of oil return:

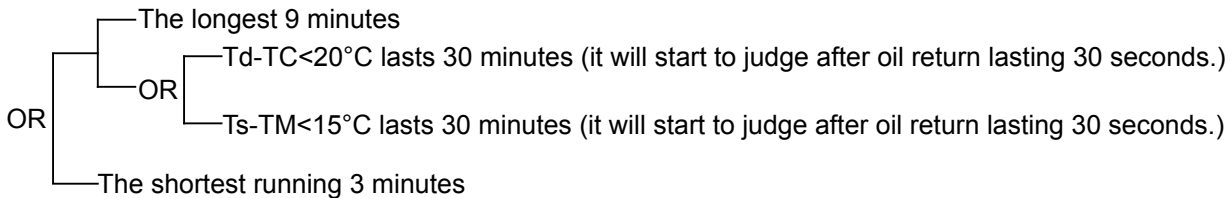
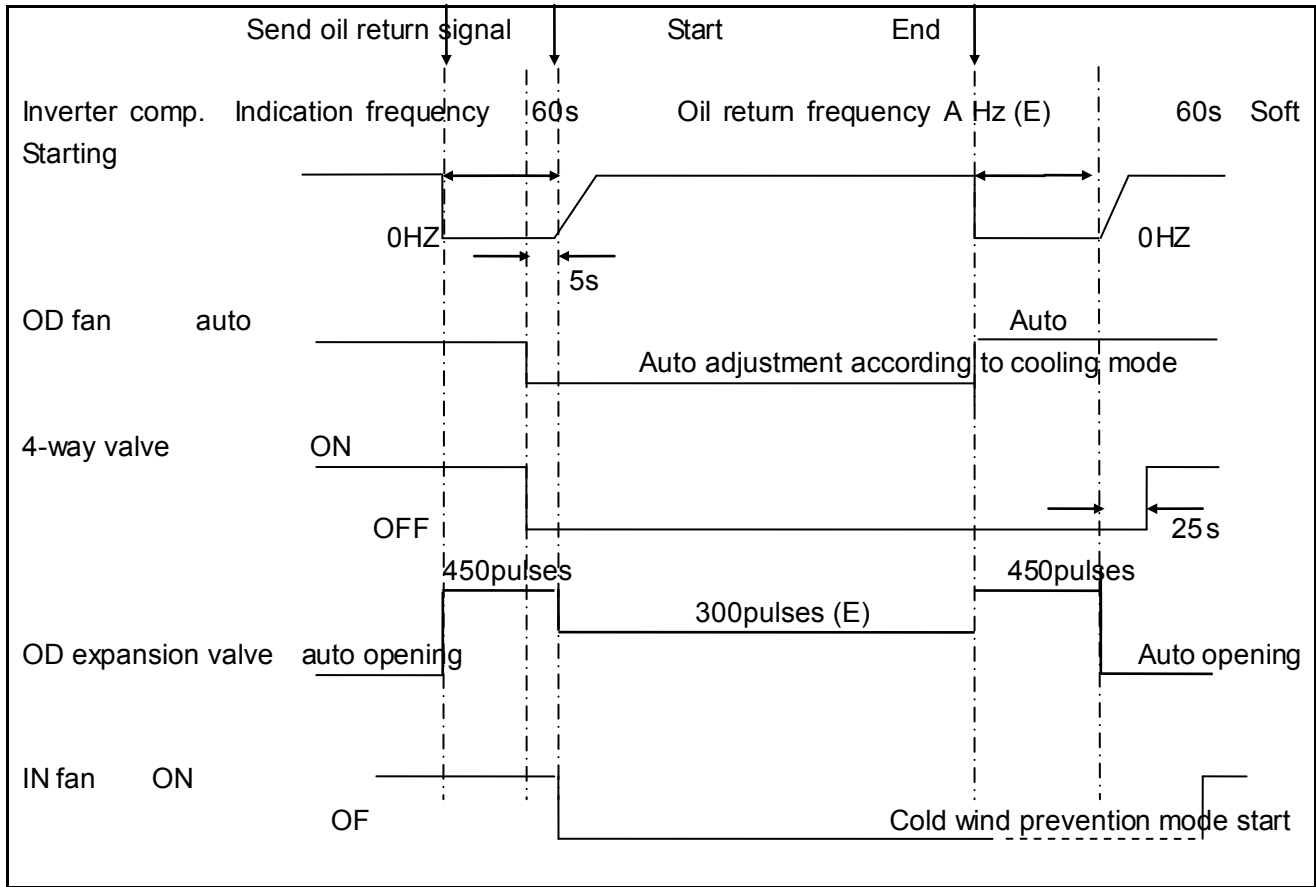

6.2.5 EEV control:

1. Set one general EEV on outdoor unit board, control the EEV by indoor unit, outdoor unit board is regarded as executing agency.

- (1) Reset the electrify valve: act one full-closed action when the first electrifying of the outdoor valve board.
- (2) Power source: switch power source, outdoor unit 13.5V (input voltage of the EEV) are the same line.

2. The electronic property of the EEV

Largest opening	500 pulse
Driving speed	PPS

Remark: considering the application of MAXI, the EEV of each model should be larger, when operating as one outdoor unit with one indoor unit, the opening of the EEV should be stable lower than 200 steps. Leave the system adjustment margin of MAXI.

3. The initialization action of the EEV.

Driving speed of the EEV: Open-way: 31.25 PPS (32MS) , Closed-way: 31.25 PPS (32MS)

full open action and full closed action of EEV: full open action: open as 470 pulse (E) , full closed action: after closing 540 pulse, repeat three times (close as 60 pulse and open as 5 pulse, it means stop at opening of 5)

4. The limitation of the EEV opening

Condition	Opening Requirement	Lower Limit	Upper Limit
Shut down	Standard opening of the model, according to the opening of last time	/	/
Standby (temperature sensor off)	Standard opening of the model, according to the mode before the temperature sensor is off	/	/
Cooling startup process	Execute the standard cooling opening of the model	Standard opening	400
Heating startup process	Execute the standard heating opening of the model	150	400
Cooling, dehumidification	Adjust automatically	70	470
Heating	Adjust automatically	70	470
Defrosting	Fixed opening	200	400
Oil return	Fixed opening	150	400
Refrigerant discharge	Fixed opening	150	400

6.2.6 Control of shutdown

1. Initiative shutdown mode (shutdown normally without protection)

When the air conditioner is in cooling or heating mode, the compressor get the shutdown signal, the current frequency of the compressor is more than 55HZ (EE) , the compressor will decrease to 48HZ at the speed of 2HZ/s and shut down directly.

If the current frequency of the compressor is lower than 55HZ, it will shut down directly after it receives the signal. Avoid that the sudden shutdown will cause too strong stress when in high working frequency.

After the compressor stops, the fan motor will execute the left heat blowing and then stops.

Shutdown because of the anti-freeze protection, the compressor will stop as initiative shut down mode/

2. Passive shut down mode (Error protection shut down)

When the system come to the pressure protection, over-current protection, high module temperature protection, high condensation temperature protection and the unit shut down, no matter the frequency of the compressor come to 55HZ, the unit will shut down directly.

6.2.7 Defrosting control in heating mode

During heating a need for defrost is detected by the outdoor coil temperature sensor, and defrosting is controlled by the ambient and coil temperature sensors.

1. Initiate defrost:

1) After compressor running in heating for continuous 10 minutes (E) and for accumulated 50 minutes (E) , by testing T_e (defrosting temp sensor) or TC (testing of outdoor exchanger frosting condition) and outdoor ambient temp sensor T_A , when it meeting the following condition for continuous 5 minutes, the unit will enter defrosting operation. In case of no defrosting operation caused by imbalanced refrigerant flow (caused by refrigerant lack or other reason) , the unit will enter defrosting when any one of the two conditions are meet.

Entering condition:

$T_e \leq C \times T_A - \alpha$ OR $TC \leq C \times T_A - \alpha$ and lasts for 5 minuts

Note: C:

$T_A < 0^\circ\text{C}$, $C=0.8$

$T_A \geq 0^\circ\text{C}$, $C=0.6$

a. Entering temp. limit of defrosting 1: $-15^\circ\text{C} \leq C \times T_A - \alpha \leq -2^\circ\text{C}$

b. Entering temp limit of defrosting 2: $C \times T_A - \alpha < -15^\circ\text{C}$ & $T_e \leq -15^\circ\text{C}$ for continuous 5 minutes & accumulated running time reaching 90 minutes.

c. Defrosting entering limit condition: indoor coil temp lower than 40 degree

d. Heating mode compressor running accumulated time stop/pause condition:

Detecting stop (end) : shifting from heating to cooling mode

Detecting pause: thermostat OFF, unit off.

2. Defrosting end condition:

After defrosting condition starts, it will last no more than 10 minutes (E) . Using T_e to test outdoor heat exchanger frosting condition, if it lasts over accumulative 60 seconds of 7°C (E) or over accumulative 30 seconds of 12°C (E) or over 15°C (E) , defrosting will stop.

3. Forced defrost:

Starting condition of forced defrosting: in heating operation (including standby state) , unit will start forced defrosting after receiving forced defrosting signal by indoor.

Indoor manual defrosting signal will keep until outdoor enters defrosting.

Note: *It can enter manual defrosting when compressor in OFF state, but it needs to follow 3-minute protection rule.*

4. Timing defrosting mode condition:

Starting condition: after setting outdoor function dip switch, it will execute timing defrosting in heating mode.

A. If outdoor ambient temp is over 10 degree (E) , even if timing defrosting is set, it will follow the auto defrosting condition, meaning auto entering and auto quitting.

B. When outdoor ambient temp is lower than 10 degree (E) (including 10 degree) , it will follow the defrosting operation as below:

When compressor runs for continuous 10 minutes (E) and runs for accumulative 50 minutes (E) , it will enter defrosting operation.

C. Timing defrosting operation and quit condition is the same as auto defrosting.

6.2.8 Four way valve control:

1. When powering on, four way valve is in OFF state.

2. In other modes except heating, the four way valve is powered off.

3. The 4-way valve is on in the heating mode, except under the following conditions:

1) in heating mode, in initial starting time of compressor to ensure the pressure difference ;

1) in defrosting operation:

a, if there is no compressor stopping, power four way valve off;

4. When shifting from heating to other modes, four way valve will power off after a while.

5. 4-way valve protection:

In heating mode, after continuous running of compressor for 10 minutes, if T_m (indoor sensor) $<$ indoor ambient temp -2°C (E) and T_e (outdoor sensor) $>15^{\circ}\text{C}$ (E) for continuously for 1 minute, four way valve will be powered off, reporting four way valve error. If the compressor starts after 3 minutes and the error is detected 3 times continuously in 1 hour, a 4-way valve error code will be displayed. The error will not be detected during defrost and within 10 minutes after termination of defrost, in the oil return mode, or within 10 minutes following an oil return cycle.

6. Only in initial starting of compressor in heating mode, outdoor fan motor and four way valve will powering on simultaneously.

7. If compressor frequency is higher than regulated frequency before off, it will lower to required frequency and then stop.

8. Compressor inverter frequency and outdoor fan speed will operate in accordance with other requirement.

Defrosting time sequence is as follows

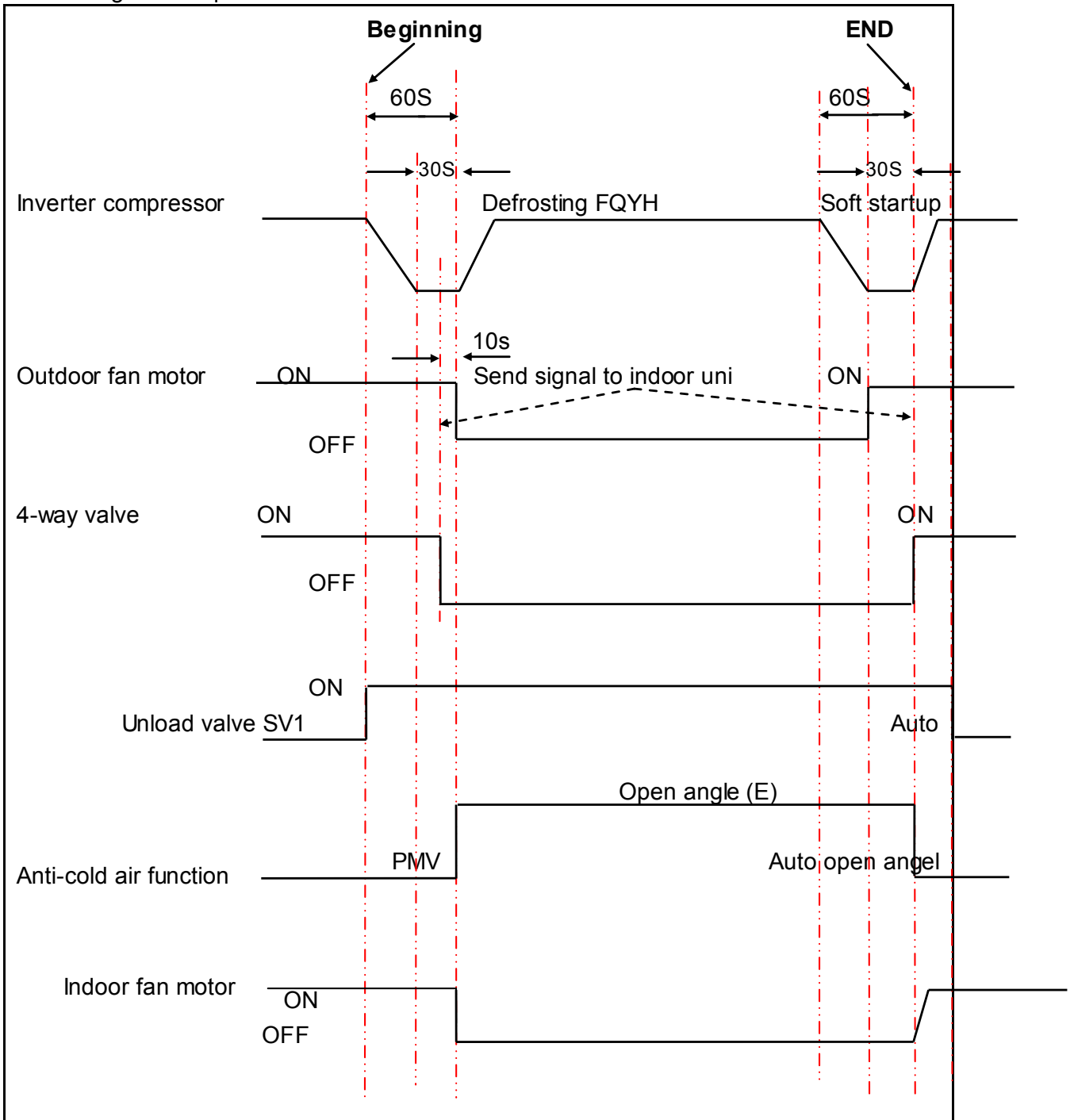

7. Controller

7.1 Remote Controller: YR-HBS01

External View of Remote Controller

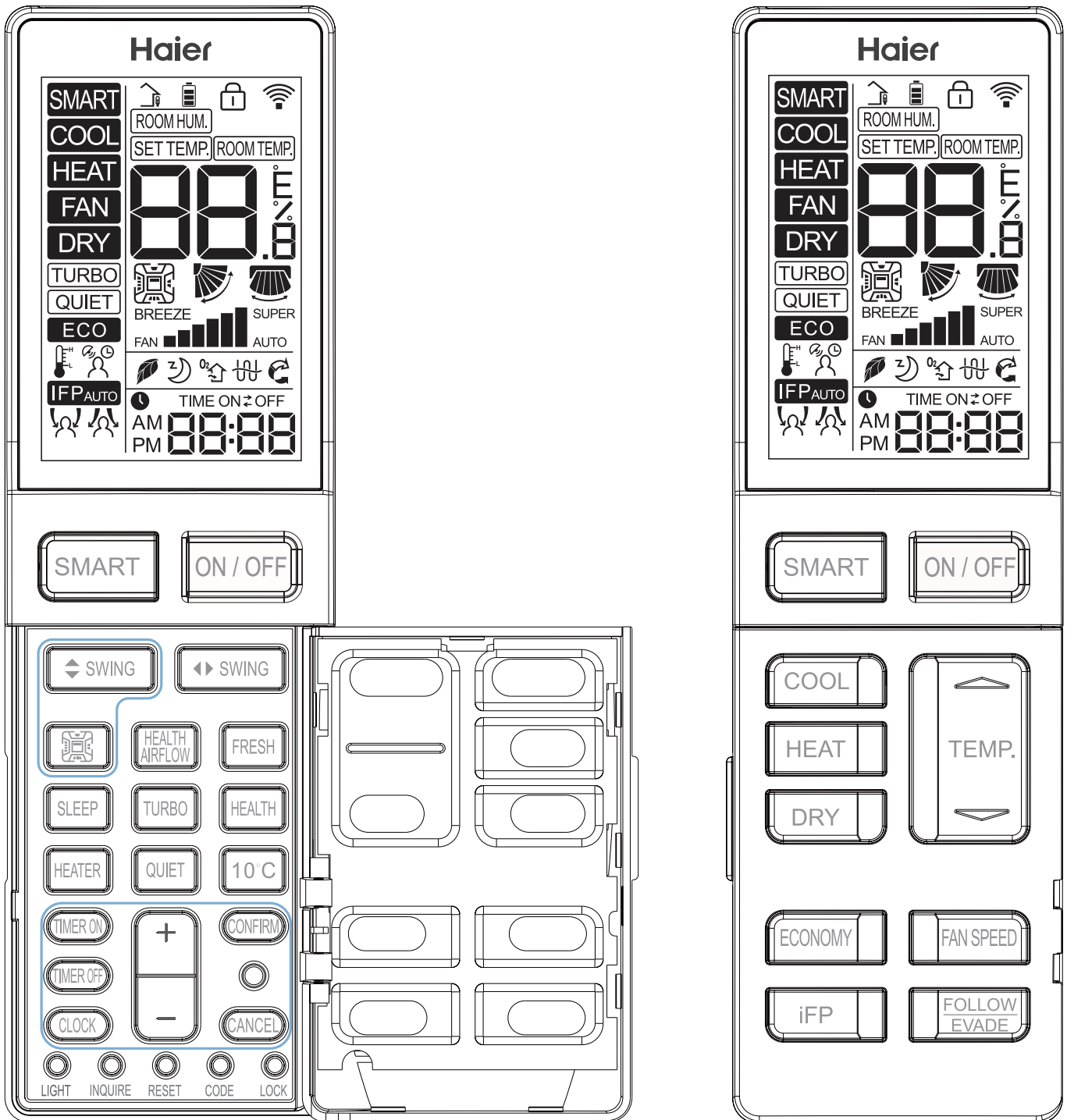

Loading of the battery

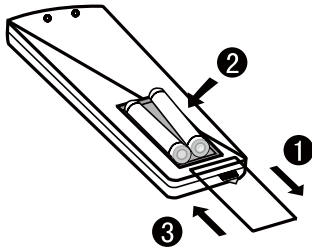

- 1.Remove the battery cover
- 2.Insert 2 AAA batteries as illustrated noting battery polarity
- 3.Reinstall the battery cover

Note:

The distance between the signal transmission head and the receiver hole should be within 7m without any obstacle as well. When electronic-started type fluorescent lamp or change-over type fluorescent lamp or wireless telephone is installed in the room,the receiver is apt to be disturbed in receiving the signals,so the distance to the indoor unit should be shorter.

Full display or unclear display during operation indicates the batteries have been used up. Please change batteries. If the remote controller can't run normally during operation, please remove the batteries and reload several minutes later.

Hint:

Remove the batteries in case won't be in use for a long period. If there is any display after taking-out, just press reset key.

Functional description:

1. Power-up and Show All: the LCD display shows all symbols in this function. 3s later, it just shows time and the initial time is AM 12:00. The initial time is adjustable and will be confirmed automatically 10s later.

2. ON/OFF Button: press the button for power on. The initial default mode is SMART, otherwise it will be the mode before power OFF. Press OFF button after power on.

3. SMART Button:

- (1) SMART button is always valid during power ON/OFF;
- (2) Press SMART button to execute power OFF in SMART mode;
- (3) In OFF and other modes, press SMART button to enter initial default setting of SMART mode. LCD setting temperature is not showed;
- (4) In SMART mode, press TEMP. +/- button to show the setting temperature.

4. COOL Button, HEAT Button and DRY Button

(1) When the remote controller in ON, press COOL button, HEAT button and DRY button to execute COOL mode, HEAT mode and DRY mode.

(2) For initial power-up, temperature and fan speed will be showed as follows when entering each mode, otherwise parameters set last time will be showed;

Mode	SMART	HEAT	COOL	DRY	FAN
Initial TEMP.	24°C	24°C	24°C	24°C	Setting temperature is not showed.
Mode	SMART	HEAT	COOL	DRY	FAN
Initial Fan Speed	AUTO	LOW	HI	AUTO	LOW

5. FAN Mode

(1) During power OFF, press "HEALTH" button or "FRESH" button to enter FAN mode with low fan speed. Meanwhile, the HEALTH or FRESH icon will be showed on the screen.



(2) Temperature is not showed in FAN mode.

(3) Auto fan speed is not available when switching fan speed in FAN mode.

6. FAN SPEED Button:

(1) In other modes except for Fan mode, LOW, MED, HI and AUTO fan speed is adjustable, switching sequence is as LOW-MED-HI-AUTO-LOW.



(2) After TURBO or QUIET is set. Press TURBO button to show **TURBO** on the screen with fan speed as , then press "FAN SPEED" button to exit; press QUIET button to show **QUIET** on the screen with fan speed as , then press "FAN SPEED" button to exit. To cancel TURBO and QUIET, press TURBO and QUIET buttons respectively, **TURBO** and **QUIET** icons will disappear and the fan speed will return to the last one.

(3) This button is invalid during power OFF.

7. TEMP. +/- Button:

(1) This button is invalid in FAN mode;

(2) Temperature adjustment range in SMART, HEAT, COOL and DRY mode: 16 ~30°C.

(3) Press and hold "TEMP. +/- " button, the temperature changes once; long press the button, the temperature changes rapidly.

8. Four-side Embedment (Available for some models):

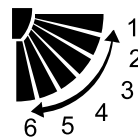

(1) Initial position of all modes for first power on:

	SMART	HEAT	COOL	DRY	FAN
Four-side Embedment	Show all	Show all	Show all	Show all	Show all
SWING Angle	Position 3	Position 5	Position 3	Position 3	Position 3

(2) After power on, press "Four-side Embedment" button for the first time and the recycle approach is as follows: four-side simultaneous control of Four-side Embedment → Four-side Embedment 1 → Four-side Embedment 2 → Four-side Embedment 3 → Four-side Embedment 4 → Four-side simultaneous control of Four-side Embedment.

(3) When pressing "Four-side Embedment" button to select air deflector, the selected air deflector flashes. Press "Up-and-down Angle" button to adjust angle of air deflector at the moment.

9. Up-and-down SWING Angle:

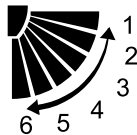

1: Position 1; 2: Position 2; 3: Position 3; 4: Position 4; 5: Position 5; 6: Position 6 (reserved)

Recycle approach: Position 1 → Position 2 → Position 3 → Position 4 → Position 5 → AUTO → Position 1

Free swing: 1 → 2 → 3 → 4 → 5 → 4 → 3 → 2 → 1 is showed circularly.

10. Right-and-left SWING Angle (Available for some models):

Recycle approach: 34 showed (Position 1) → 25 showed (Position 2) → 16 showed (Position 3) → 1 showed (Position 4) → 2 showed (Position 5) → 5 showed (Position 6) → 6 showed (Position 7) → Auto swing

Auto swing approach: 1 → 2 → 3 → 4 → 5 → 6 → 5 → 4 → 3 → 2 → 1 are showed circularly.



11. HEALTH AIRFLOW (Available for some models):

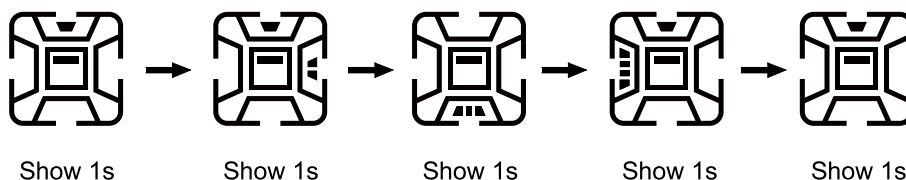

Press "HEALTH AIRFLOW" button to show  icon on LCD display. Each air deflector of swings on four sides alternates circularly to indicate that the swing rotates to exhaust air. Meanwhile, up-and-down SWING angle shows AUTO SWING. Press it again to cancel HEALTH AIRFLOW.



12. SLEEP:

- (1) Valid during power on.
- (2) The SLEEP time is fixed to 8 hours and is not adjustable.
- (3) It is invalid in FAN mode. When setting TIMER ON or TIMER ON to TIMER OFF after setting SLEEP function, once the timer setting is successful, the SLEEP function will be cancelled; after setting TIMER ON or TIMER ON to TIMER OFF, the SLEEP function cannot be set. SLEEP function can be set from TIMER OFF to TIMER ON, TIMER OFF and SLEEP function have priority in canceling the opposite side.







13. HEALTH:

- (1) During power-on or power-OFF, press "HEALTH" button to display icon  on LCD display, and press "HEALTH" button again to cancel.
- (2) During power-OFF, press "HEALTH" button to enter blowing-in mode, start low wind and HEALTH mode, display icon .
- (3) Switch among modes, and keep HEALTH function.
- (4) If HEALTH function is set, power OFF and then on to stay in HEALTH mode.



14. ECO:

- (1) Press ECO button and the display will show .
- (2) ECO is valid under all modes, it is memorized among switch of all modes.
- (3) ECO function power-on or power-OFF is memorized.

15. Turbo/Quiet:

- (1) Press button "Turbo" display icon  on remote LCD display, display icon  of fan speed; Press button "Quiet" display icon  on remote LCD display, display icon  of fan speed.
- (2) Turbo and QUIET functions can not exist at the same time, the latter will replace the former.
- (3) If Turbo function is set, press "SLEEP" button to exit turbo, which means that setting SLEEP function while canceling turbo function. At the same time, the icon  disappears and icon  is shown; if QUIET function is set at present, press button "SLEEP" while QUIET function is still kept.
- (4) This function is valid under the mode of COOL or HEAT.
- (5) Turbo/QUIET functions are not memorized among switch of all modes/the state of on or OFF.

16. IFP:

- (1) Press "IFP" button, display , IFP function is set, and press "IFP" button again to cancel.
- (2) Press "Follow/Evade" button, display  that expresses following; press it again, display  that expresses evading.
Press it the third time to cancel.

(3) If follow/evade functions are set, air-out angle will change with position of people, so after setting these functions, Four-side Embedment icons in all sides, up-and-down SWING and left-and-right SWING icons will disappear.

(4) If air conditioner is in the state of HEALTH airflow, follow/evade functions are set, HEALTH airflow function is cancelled, Four-side Embedment, up-and-down SWING and left-and-right SWING icons will disappear.

17. FRESH (available for some models):

- (1) FRESH function is valid under the state of on or OFF. When air conditioner is OFF, press "FRESH" button, display icon  on LCD display to enter blowing-in mode and low speed. Press "FRESH" button again, this function is cancelled.
- (2) After FRESH function is set, on or OFF functions are kept.
- (3) After FRESH function is set, mode switch function is kept.

18. 10°C Heating Function (available for some models) :

This function is valid only under the mode of HEAT, and it is not memorized under the state of on or OFF.

19. HEAT (available for some models) :

- (1) When HEAT mode is chosen  and is displayed on LCD display, pressing "HEAT" button can cancel and set HEAT function.

(2) Auto mode will not start HEAT function automatically, but can set or cancel HEAT function.

20. Timer:

(1) TIMER ON

- Press "TIMER ON" button, character "ON" is flashing, press "+/-" button to adjust, then press "OK" button to confirm, if "OK" button is not pressed within 10 s, TIMER ON function is cancelled.
- If time of TIMER ON is the same as that of clock at present, character "ON" is always flashing and can not be verified, it is necessary to readjust time.
- When the time of TIMER ON is end, the setting time and character "on" disappear.

(2) TIMER OFF

- Press "TIMER OFF" button, character "OFF" is flashing, press "+/-" button to adjust, then press "OK" to confirm, if "OK" is not pressed within 10 s, TIMER OFF function is cancelled.
- If time of TIMER ON is the same as that of clock at present, character "OFF" is always flashing and can not be verified, it is necessary to readjust time.
- When the time of TIMER OFF is end, the setting time and character "OFF" disappear.

(3) TIMER ON/OFF

- After TIMER ON/OFF is set, remote will automatically judge sequential order of ON/OFF, arrow indicates that the one performed first points to the one performed second.
- After the time of clock performed first is end, corresponding characters of timer "ON/OFF" disappear.
- If time of TIMER ON is the same as that of TIMER OFF, and can not be verified, corresponding character of the latter of setting time is always flashing, it is necessary to readjust time and confirm again.
- If time of TIMER ON/OFF is the same as that of clock at present, and can not be verified, it is necessary to readjust time and confirm again.

(4) After setting timer, display the setting of timer first and then display time all the time, when timer is active, character "ON/OFF" is always displayed.

21. Button +/-:

- Press button "+/-" time will change in terms of 1 min as unit, pressing and holding the button will change quickly.

22. Clock:

- Press "Clock" button, "Morning" or "Afternoon" displayed at present are flashing to enter the state of clock adjustment, adjust clock and then press "OK" to confirm.
- It is valid under the state of ON/OFF.

23. LIGHT:

- No display on remote controller LCD, which is processed by indoor unit.

24. RESET:

- Perform one power on reset operation when RESET button is pressed.

25. LOCK:

- Press button Lock, display Lock symbol on LCD display, buttons on remote controller can not be used, press button Lock again to unlock.

26. CODE:

- Function reserved.









27. INQUIRE

- Processing by Indoor unit

7.2 Wired controller: YR-E17

WIRED CONTROL PANEL FUNCTIONS









Features and Interface

 88:88	Clock; Parameter setting/Inquiry; Malfunction display
 88:88 ON → OFF	Timer ON/OFF; Sleep function; Parameter setting/Inquiry; Malfunction display
ROOM SET 88.8 °C / °F	ROOM/SET temp. and humidity display, each step is 0.5° C (1° F). For example, if the temp is 25° C (77° F), it will display 25.° C (77° F). Humidity display function is reserved.
ECO	Energy Saving function. This icon will be displayed only when energy saving function is set.
	Filter Cleaning
	Child Lock
	Lock/Central
	Motion Sensing (Reserved)
	Left/Right Swing. This icon is displayed only when in swing function
	Up/Down Swing. This icon is displayed only when in swing function



User Friendly: Back light; Room temperature display

Functions: Clock; Timer; Sleep Function; Heat Reclaim Ventilation; ECO; Filter Cleaning; Error Code display; Child Lock; Parameter Inquiry; Unit NO. Setting; Static Pressure Grade Inquiry; Temp. Compensation setting; Forced Cooling/Heating

	Sleep function. This icon is displayed when setting the sleep function. Remaining sleeping time is displayed in the top right corner.
	Heat Reclaim Ventilation. This icon is displayed when setting the heat reclaim ventilation.
	Electrical Heating. This icon is displayed when electrical heating is set on DC wired control.
	Intelligent Mode--automatic cycling.
	Cooling Mode
	Heating Mode
	Fan Mode
	Dry Mode

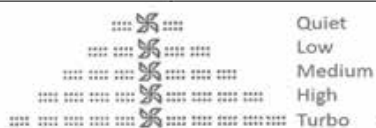

Fan speed will be changed in sequence as :
Quiet → Low → Medium → High → Turbo → Auto

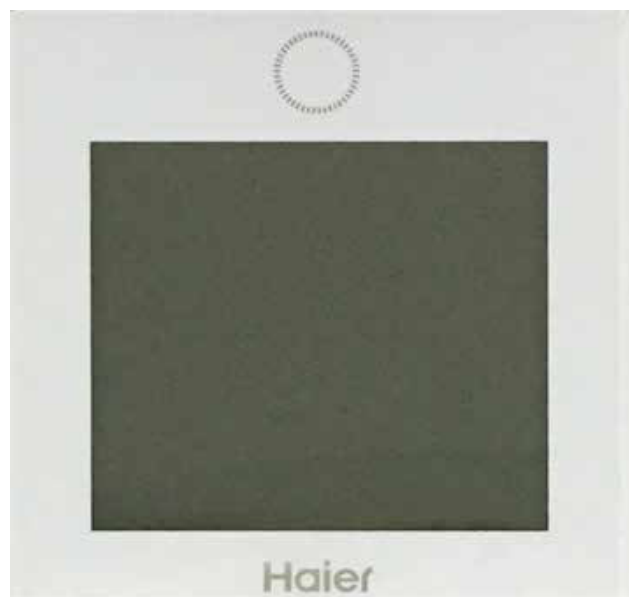

WIRED CONTROLLER INSTALLATION

Wired Controller Wiring Instructions

Step By Step Guide To Installation

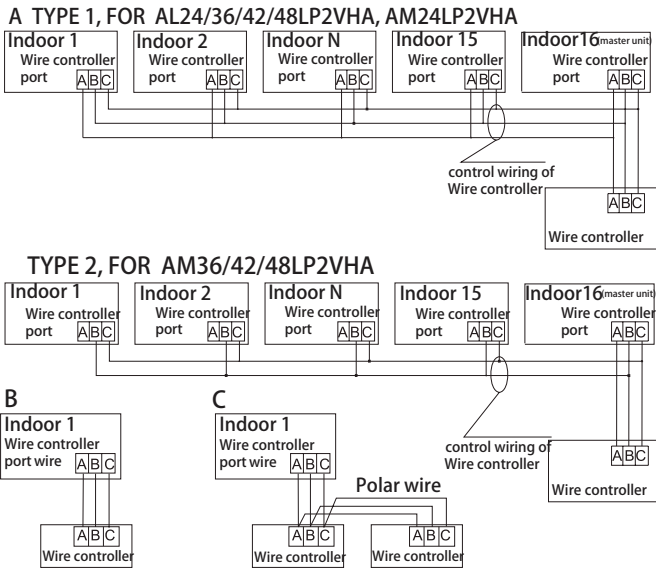

There are three methods to connection wire controller and the indoor units:

A: One wired controller can control max.up to 16 sets of indoor units, for Flexifit Pro series indoor units, there are two connection method

Type 1: for model AL24/36/42/48LP2VHA,AM24LP2VHA,the wiring connection between wired controller - the master unit (directly connected to the wired controller), master unit - slave unit, slave unit-slave unit should be one to one match of all three lines.

Type 2: for model AM36/42/48LP2VHA,The wiring connection between wired controller-the master unit (directly connected to the wired controller) should be three polar wire, and the wiring between master unit - slave unit, slave unit-slave unit should be one to one match of two polar lines.

Note: PCB DIP switches are used for setting slave units, please refer to indoor unit wiring diagram.

B. One wire controller controls one indoor unit, and the indoor unit connects with the wire controller through 3 pieces of polar wire.

C. Two wired controllers control one indoor unit. The wire controller connected with indoor unit is called master one, the other is called slave one. Master wire controller and indoor unit; master and slave wire controllers are all connected through 3 pieces of polar wire.

Note: There are PCB DIP switches for slave or master units selection, please refer to the indoor unit wiring diagram to get details.

About the wire:

The wire controller is equipped with special communication wiring in the accessories. 3-core terminal (1-white 2-yellow 3-red) is connected with the terminal A, B, C of wire controller respectively.

The communication wiring is 189ft (4.8 meter) long; if the actual length is more than it, please distribute wiring according to below table:

Communication Wiring

Communication Wiring length	Dimension of Wiring
0~100 ft (0~30m)	22AWG(0.3mm ²)x3-core shielded wire
100~200 ft (30~60m)	20AWG(0.5mm ²)x3-core shielded wire
200~300 ft (0~90m)	18AWG(0.75mm ²)x3-core shielded wire
300-400 ft (90~120m)	16AWG(1.25mm ²)x3-coreshielded wire

*One side of the shielded sheet of communication wire must be earthed.

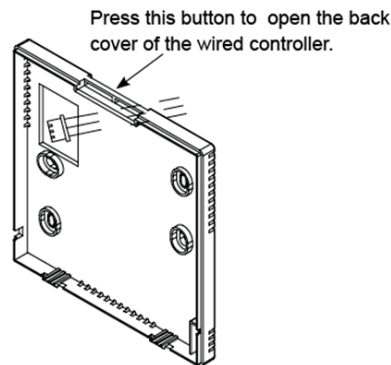

Put communication wire through the hole in the back cover as shown

Mount the back cover in the desired location, making sure not to pinch the communication wire. Then connect the communication wire to CON1 port of the wired controller.

Replac

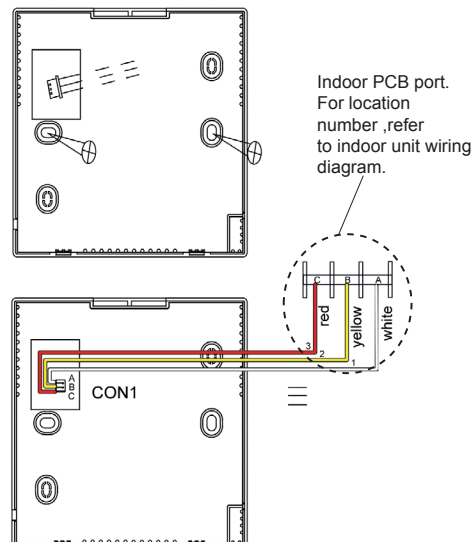

WIRED CONTROLLER INSTALLATION

Wired Controller Wiring Instructions

Dimensions

Unit: inch (mm)

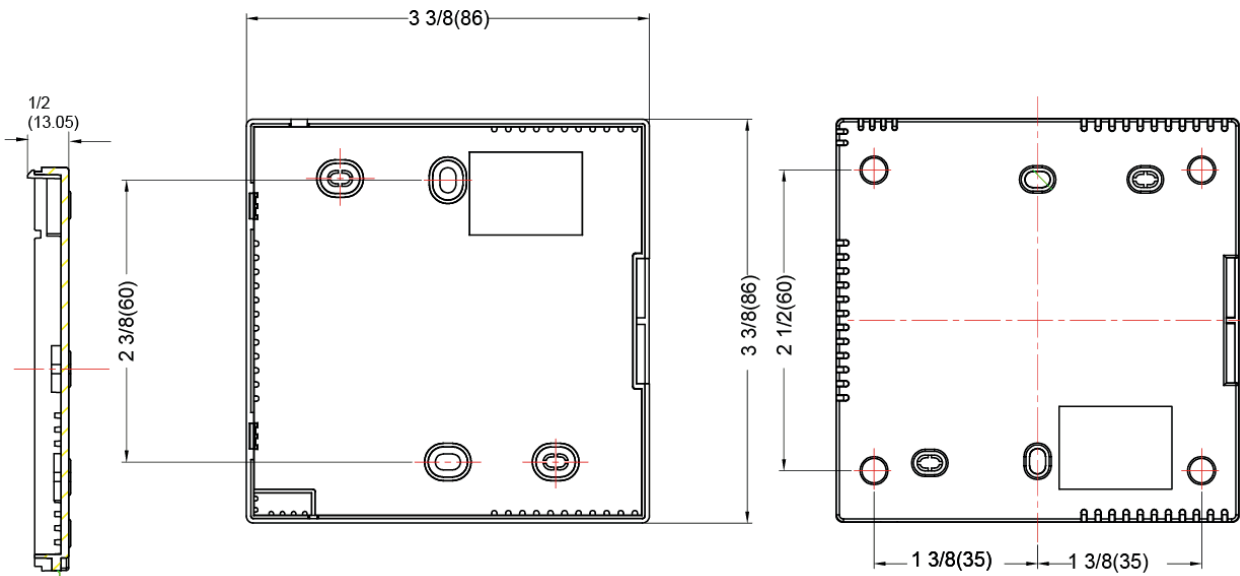

Dip Switch

Dip Switch	ON/OFF	Function	Default Setting
SW1-1	ON	Set as the slave controller	OFF
	OFF	Set as the master controller	
SW1-2	ON	Ambient temp. display available	OFF
	OFF	Ambient temp. display unavailable	
SW1-3	ON	Display ambient temp. from PCB of indoor	OFF
	OFF	Display ambient Temp. from wired controller	
SW1-4	ON	Auto-restart invalid	OFF
	OFF	Auto-restart valid	
SW1-5	ON	Fahrenheit	OFF
	OFF	Celsius	
SW1-6	ON	Swing angle adjustment available	OFF
	OFF	Swing angle adjustment unavailable	
SW1-7	ON	Up/Down and Left/Right swing	OFF
	OFF	Up/Down swing	
SW1-8	ON	Fresh Air unit	OFF
	OFF	General unit	

WIRED CONTROLLER OPERATION

Settings & Functions

Initialization



The wired controller will momentarily display all display icons upon powering up or when resetting the system.

During the initialization process, the controller will display, in a repeating order: 88:88 (upper left corner), 88:88 (upper right corner) 88.8 (main temperature).

This cycle keeps repeating until initialization is complete. The green ON/OFF LED will also flash continuously until initialization is complete.

If the wired controller is unable to communicate with the indoor unit PCB after powering on, initialization will terminate in 4 minutes. The communication malfunction can be checked using the malfunction inquiry function. (See Malfunction Display)

Mode Setting

NOTE: This function requires the ON/OFF key LED to be turned OFF and the screen backlight to be illuminated. Press and hold the MODE key for 5 seconds, the number of the mode currently being used will display in the upper left corner of the screen. (Default is 0) Press the ▲▼ keys to change to one the different modes available: 0, 1, 2, or 3. Press SET to confirm the setting.

NOTE: Corresponding modes

- 0 – [Intelligent] [Cooling] [Heating] [Fan] [Dry]
- 1 – [Cooling] [Heating] [Fan] [Dry]
- 2 – [Cooling] [Fan] [Dry]
- 3 – [Cooling] [Heating] [Fan] [Dry] (same as 1)

Error Code Display

Note: This function requires the ON/OFF key LED to be turned OFF and the screen backlight to be illuminated. Press and hold the TIME key for 10 seconds. The unit number will display in the upper left corner of the screen. The error code/historical error code will display in the upper right corner of the screen. Press ▲▼ keys to select the unit number to view its error codes. Under Error Code display screen, press and hold the TIME key for 5 seconds to clear the fault codes of all the units.

Press the MODE, FAN, TIME, SET, or ON/OFF key to exit the function. If no key is pressed in 10 seconds, the function will also exit. If there are no current errors or historical error codes, "--" will be displayed.

Switching between Fahrenheit & Celsius

To switch from Celsius to Fahrenheit, select the mode you wish to operate (COOL, HEAT, DRY, INTELLIGENT/AUTO). Press and hold the ▲ key to reach 30 ° C then continue holding the ▲ key for 15 seconds until the display reads 86 ° F. Use the ▲▼ keys to adjust to desired temperature.

To switch from Fahrenheit to Celsius, select the mode you wish to operate (COOL, HEAT, DRY, INTELLIGENT/AUTO). Press and hold the ▼ key to reach 60 ° F then continue holding the ▼ key for 15 seconds until the display reads 16 ° C. Use the ▲▼ keys to adjust to desired temperature.

Clock Function



1. The clock is displayed in 24 Hour time
 - A. It cannot be set for AM/PM.
 - B. The clock function cannot be set when SLEEP function or a timer function is currently set.

When the system is first powered up, after initialization, the clock will default to 12:00. Within 10 seconds of the clock being displayed, the time can be set. The clock icon and minutes portion of the time display will be flashing. Press the ▲▼ keys to adjust the minutes. (Pressing and holding the ▼ keys will accelerate the time adjustment.) With the minutes set, press the TIME key. The clock icon and hours portion of the time display will now begin flashing. Press the ▲▼ keys to adjust the hours. Press the SET key to confirm the setting.

To set the clock after initial power up or reset time has expired, press and hold the TIME key for 5 seconds. The clock icon and minutes portion of the time display will begin flashing. Press the ▲▼ keys to adjust the minutes. With the minutes set, press the TIME key. The clock icon and hours portion of the time display will now begin flashing. Press the ▲▼ keys to adjust the hours. Press the SET key to confirm the setting. If neither ▲▼ key is pressed within 10 seconds, or if the MODE, FAN, or ON/OFF keys are pressed prior to pressing the SET key, the setting function is canceled and the time reverts back to the previous setting.

Screen Saving

With the system turned off, tap the TIME key to activate the screen backlight (if not already lit).

1. Press and hold the TIME and ▼ keys for 5 seconds to set the backlight "on" time. The set time will be displayed in the upper right corner of the screen.
2. Press the ▲▼ keys to adjust the time. Set times available are: 0 seconds (backlight always on), 15 seconds, 30 seconds, and 60 seconds. Initial default time is 15 seconds.
3. With time selection made, press the SET key to confirm the setting.

If neither ▲▼ key is pressed within 10 seconds, or if the MODE, FAN, or ON/OFF keys are pressed prior to pressing the SET key, the setting function is canceled and reverts back to the previous setting.

WIRED CONTROLLER OPERATION

Settings & Functions

ECO Energy Saving Function

NOTE: This function requires the ON/OFF key LED to be turned ON and the screen backlight to be illuminated.

ECO

Press the SET key. The swing louver function icon will be displayed. Press the ▲▼ keys to advance through the functions to select ECO function. (The icon will be flashing) Press the SET key to confirm the setting. The ECO icon will remain on.

To cancel ECO function, repeat the above steps.

NOTE: The energy saving default parameters are listed below:
 74° F Lowest temperature limit of Cooling and Dry mode.
 78° F Highest temperature limit of Heating mode.
 74° F – 86° F Temperature adjustment range in Cooling and Dry mode.
 60° F – 78° F Temperature adjustment range in Heating mode.

ECO Parameter Setting

NOTE: This function requires the ON/OFF key LED to be turned ON and the screen backlight to be illuminated.

For Cooling

Under Cooling mode, set the temperature to 86° F. Press and hold the FAN key for 5 seconds. The Cooling ECO parameter (flashing) will be displayed in the upper left corner of the screen. Default temperature is 74° F. Press the ▲▼ keys to adjust the lowest target cooling temperature. Press the SET key to confirm the setting and exit setup.

For Heating

Under Heating mode, set the temperature to 60° F. Press and hold the FAN key for 5 seconds. The Heating ECO parameter (flashing) will be displayed in the upper right corner of the screen. Default temperature is 78° F. Press the ▲▼ keys to adjust the highest target heating temperature. Press the SET key to confirm the setting and exit setup.

Static Pressure Grade Inquiry & Adjustment

NOTE: This function requires the ON/OFF key LED to be turned ON and the screen backlight to be illuminated.

Press and hold the SET and FAN keys for 5 seconds. The current static pressure will be displayed in the upper right corner of the screen and the "Static Pressure" icon will begin to flash.

Press the TIME key to shift the unit no. displayed in the upper left corner of the screen. The unit numbers are from 00-15. Press the ▲▼ keys to change the static pressure grade, shown in the upper right corner of the screen. Number range is 01-04. Press the SET key to confirm the setting. Press the MODE, FAN, or ON/OFF key to exit the function. If no key is pressed in 10 seconds, the function will also exit.

Timer Function Setting

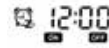

NOTE: The display backlight must be illuminated before proceeding. To turn the backlight on, press any key (MODE, FAN, ▲▼, TIME, or SET) located at the bottom of the display, or press the ON/OFF key located at the top of the display.

Timer ON

Press the TIMER key once, the ON timer icon will appear in the upper right corner of the screen. The ON icon and hour position are flashing. Press the ▲▼ keys to set the hour. Press the TIMER key again, the ON icon and minutes position are now flashing. Press the ▲▼ keys to set the minutes. Press the SET key to confirm the setting.

Timer OFF

Press the TIMER key 3 times, the OFF timer icon will appear in the upper right corner of the screen. The OFF icon and hour position are flashing. Press the ▲▼ keys to set the hour. Press the TIMER key again, the OFF icon and minutes position are now flashing. Press the ▲▼ keys to set the minutes. Press the SET key to confirm the setting.

Timer ON/OFF

Press the TIMER key 5 times, the ON/OFF timer icon will appear in the upper right corner of the screen. The ON icon and hour position are flashing. Press the ▲▼ keys to set the hour. Press the TIMER key again, the ON icon and minutes position are now flashing. Press the ▲▼ keys to set the minutes. Press the TIMER key again, the OFF icon and hour position are now flashing. Press the ▲▼ keys to set the hour. Press the TIMER key again, the OFF icon and minutes position are now flashing. Press the ▲▼ keys to set the minutes. Press the SET key to confirm the setting. Based on the times set, the indoor unit will determine which event happens first (ON-OFF or OFF-ON) and adjusts the arrow direction accordingly.

If neither ▲▼ key is pressed within 10 seconds, or if the MODE, FAN, or ON/OFF keys are pressed prior to pressing the SET key, the setting function is canceled and reverts back to the previous setting.

Timer Cancel

Press the TIME key up to 9 times to cycle through the timer settings. When the timer icon disappears, the timer function is canceled.

Note: An active timer function will remain displayed on screen until the set time has been reached and command completed.

WIRED CONTROLLER OPERATION

Settings & Functions

Left/Right/Up/Down Swing



The swing function determines air circulation.

1. Press SET key to access Swing function circulation.
2. Use ▲▼ keys to select desired swing function.

If SW7 is on, air will circulate UP/DOWN/LEFT/RIGHT.

3. Press SET key to confirm swing function selection.

Forced Cooling/Heating

Note: This function requires the ON/OFF key LED to be turned OFF and the screen backlight to be illuminated.

Forced Cooling

When the system is turned off in cooling mode, press and hold the ON/OFF key for 10 seconds. The system will enter forced cooling. The temperature display will display a flashing "LL". Press the ON/OFF key to exit forced cooling mode.

Forced Heating

When the system is turned off in heating mode, press and hold the ON/OFF key for 10 seconds. The system will enter forced heating. The temperature display will display a flashing "HH". Press the ON/OFF key to exit forced heating mode.

NOTE: When in forced cooling or heating, all keys are disabled except for the ON/OFF key.

Parameter Inquiry

NOTE: This function requires the screen backlight to be illuminated. The ON/OFF key LED can be either On or Off.

Press and hold the SET key for 5 seconds. The unit number will be displayed in the upper left corner of the screen. The data type and current data will be displayed in the upper right corner of the screen.

Press the ▲▼ keys to scroll through the data types. (See chart for data type/current data)

Press the MODE, FAN, SET, or ON/OFF key to exit the function. If no key is pressed in 10 seconds, the function will also exit.

Data	Type meaning	System
A	Indoor sensor Tai temp.	Actual value, decimal sys.
b	Indoor sensor Tc1 temp.	Actual value, decimal sys.
C	Indoor sensor Tc2 temp.	Actual value, decimal sys.
d	Indoor unit PMV opening/2	Actual value, decimal sys.
E	Indoor unit address	Actual value, hexadecimal sys.
F	Indoor unit central address	Actual value, hexadecimal sys.

Unit Number Setting

NOTE: This function requires the screen backlight to be illuminated. The ON/OFF key LED can be either On or Off.

Press and hold the SET key for 10 seconds. The wired controller address and communication address between the indoor and outdoor unit are displayed in the upper left corner of the screen. The central address is displayed in the upper right corner of the screen.

Press the ▲▼ keys to select the indoor unit number: 0 - 3F. Press the SET key to confirm the setting. Press the MODE, FAN, or ON/OFF key to exit the function. If no key is pressed in 10 seconds, the function will also exit.

Child Lock Function



NOTE: This function requires the screen backlight to be illuminated. The ON/OFF key LED can be either On or Off.

Child Lock can be used to prevent unintended operation of the control unit.

1. Press SET and the ▼ keys together for 5 seconds to activate the Child Lock function. The child lock icon will be displayed on the left side of the screen. All normal functions of the keys will be disabled.

2. To unlock the Child Lock function, press the SET key and the ▼ arrow together for 5 seconds. The child lock icon will disappear from the screen. All normal functions of the keys will be restored.

Temperature Compensation Setting

Note: This function requires the ON/OFF key LED to be turned OFF and the screen backlight to be illuminated.

Press and hold the FAN keys for 5 seconds, the current temperature compensation value is displayed in the upper right corner of the screen. (The default value is 00). Press the ▲▼ keys to change the temperature compensation value. The adjustment range is -07° F to +07° F. Press the SET key to confirm the setting. Press the MODE, FAN, TIME, or ON/OFF key to exit the function. If no key is pressed in 10 seconds, the function will also exit.

NOTE: The compensation value is used for ambient temperature and is valid only for the wired controller sensor.

WIRED CONTROLLER OPERATION

Settings & Functions

Sleep Function

NOTE: This function requires the ON/OFF key LED to be turned ON and the screen backlight to be illuminated.



Press the SET key. The swing louver function icon will be displayed. Press the ▲▼ keys to advance through the functions to select the SLEEP function. The Sleep and Sleep "off" time icons will be displayed. (The Sleep icon will be flashing) Press the TIME key, the "off" icon will begin to flash. Press the ▲▼ keys to set the "off" time. (Time range is 0.5h to 72h) Press the SET key to confirm the setting. The Sleep function and "off" time icons will remain on.

If neither ▲▼ key is pressed within 10 seconds, or if the MODE, FAN, or ON/OFF keys are pressed prior to pressing the SET key, the setting function is canceled and reverts back to the previous setting.

To cancel the Sleep function. Press the SET key. The swing louver function icon will be displayed. Press the ▲▼ keys to advance through the functions to select the SLEEP function. The Sleep and Sleep "off" time icons will be displayed. (The Sleep icon will be flashing) Press the SET key to cancel the function.

Filter Cleaning

NOTE: This function requires the ON/OFF key LED to be turned ON and the screen backlight to be illuminated.

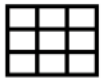

The Filter Cleaning icon will start flashing when the indoor unit has reached 500 hours of operating time.

After cleaning or replacing the filter, press the SET key to clear the icon and reset the operating time.

Heat Reclaim Ventilation

NOTE: This function requires the ON/OFF key LED to be turned ON and the screen backlight to be illuminated.



Press the SET key. The swing louver function icon will be displayed. Press the ▲▼ keys to advance through the functions to select the Heat Reclaim Ventilation function. (The icon will be flashing) Press the SET key to confirm the setting.

To cancel the Heat Reclaim Ventilation function, repeat the above steps.

If neither ▲▼ key is pressed within 10 seconds, or if the MODE, FAN, or ON/OFF keys are pressed prior to pressing the SET key, the setting function is canceled and reverts back to the previous setting.

This function is reserved for future models.

Other Functions

Note: These functions require the ON/OFF key LED to be turned OFF and the screen backlight to be illuminated.

Auto Restart

Setting DIP switch SW1-4 located on the PCB of the wired control to the "on" position will disable the auto restart function. When the switch is in the "off" position, auto-restart is enabled (default position). When the switch is in the "on" position, auto-restart is disabled.

Information retained in auto-restart are: Mode, Fan Speed, Temperature Setting, Swing State, and Heat Reclaim Ventilation function.

Communication Error of Wired Controller

If there is no communication between the wired controller and indoor unit for 4 minutes, when checking error codes, "07" will be displayed in the upper right corner of the display.

Appendix Sensor Characteristic

Model	Sensor Name	Part Code	Charcteristic
AL24LP2VHA AL36LP2VHA AL48LP2VHA AM24LP2VHA AM36LP2VHA AM48LP2VHA	Ambient temp. sensor	001A3900159	R25=23KΩ±3% B25/50=4200K±3%
	Indoor coil temp. sensor	0010401922	R25=10KΩ±3% B25/50=3700K±3%
1U24LP2VHA 1U36LP2VHA 1U48LP2VHA	Defrosting temp. sensor	0010450194	R25=10KΩ±3% B25/50=3700K±3%
	Ambient temp. sensor	0010450192	R25=10KΩ±3% B25/50=3700K±3%
	Discharging temp. sensor	0010451303	R80=50KΩ±3% B25/50=4450K±4%
	Outdoor coil temp. sensor	0010451329	R25=10KΩ±3% B25/50=3700K±3%
	Sunction temp. sensor	0010451307	R25=10KΩ±3% B25/50=3700K±4%



Haier Commercial Air Condition

ADDRESS: No.1 Haier Road, Hi-tech Zone, Qingdao 266101 P.R.China

Web: [Http://www.haier.com](http://www.haier.com)